



DOORS - MOULDINGS - STAIR PARTS  
HARDWARE

## SOLID WOOD DOORS





## DOORS

Barn Doors & Barn Door Hardware	39-41
Colonial	4-5
Contemporary	6-7
Craftsman	8-9
French Country	10-11
Mediterranean	12-13
Modern Farmhouse	14-15
Tudor	16-17
Tuscan	18-19
Victorian	20-21
Reference Guide – Panel Doors	22-25
Louver and Dutch Doors	26
1-3/8" Interior Panel & Rail Options	27-28
1-3/4" Interior Panel & Rail Options	29-30
1-3/4" Exterior Panel & Rail Options	31
2-1/4" Interior Panel & Rail Options	32
2-1/4" Exterior Panel & Rail Options	33
Applied Moulding Options	34
Signature Prime™ Doors	36
Fire Rated Doors	37
Reference Guide – Lited Doors	42-46
Transom Sashes	47
Sidelites	48
Interior Glass Options	50-51
Exterior Glass Options	52
Custom Glass Options	54-55
Hardware	56-59
Jambs & Accessories	60-61
Wood Species	62

## DOOR INFORMATION

63

Photographs shown in this catalog are for reference only. Please confirm specifications with your sales representative prior to ordering.







Courtesy - Loyd Builders, Apex NC

# COLONIAL

CLASSIC, STATELY DESIGN.

## Recommended Door Profile

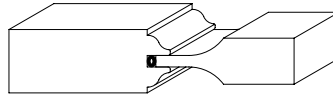

B11-241

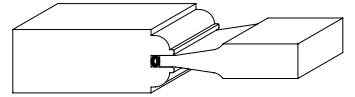

E11-131

## PANEL DOORS

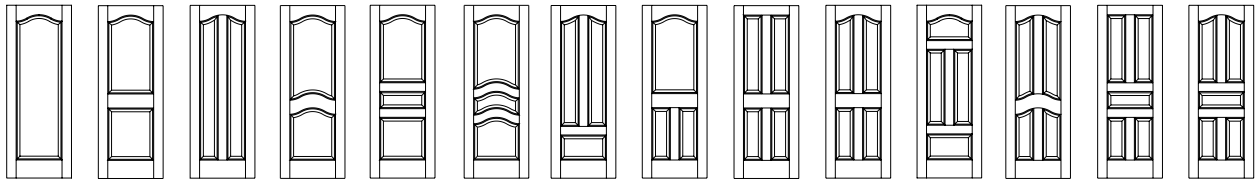

KW1300 KW2300 KW2320 KW2340 KW3300 KW3301 KW3360 KW3390 KW4000 KW4300 KW4304 KW4390 KW5000 KW5300

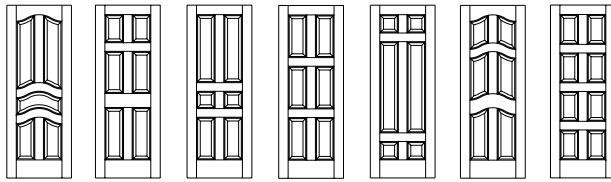

KW5390 KW6000 KW6030 KW6040 KW6060 KW6370 KW8000

## LITED DOORS

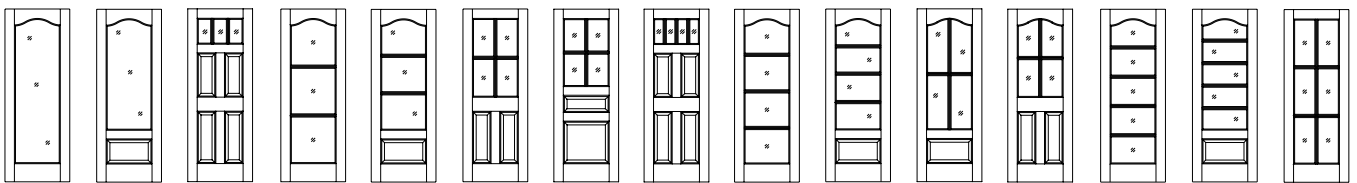

G01300 G01311 G03040 G03300 G03311 G04020 G04021 G04040 G04300 G04311 G04312 G04320 G05300 G05310 G06001

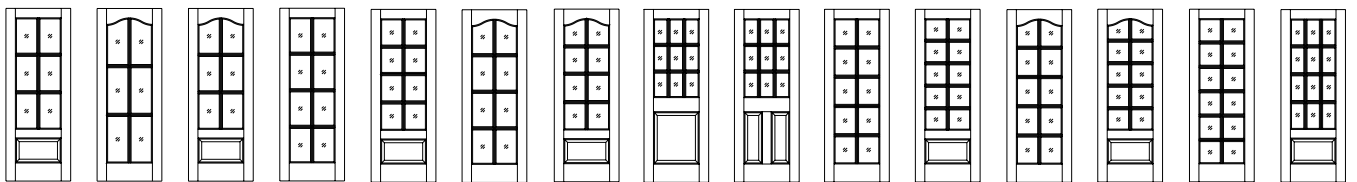

G06011 G06301 G06311 G08000 G08011 G08300 G08311 G09010 G09020 G10000 G10010 G10300 G10310 G12000 G12011

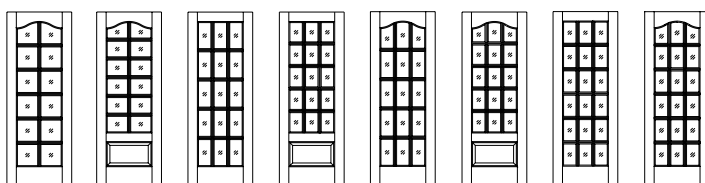

G12300 G12310 G15000 G15010 G15300 G15310 G18000 G18300





Courtesy - MBN Properties, Columbia City, IN

# CONTEMPORARY

CLEAN LINES WITH SUBTLE SOPHISTICATION.

## Recommended Door Profile

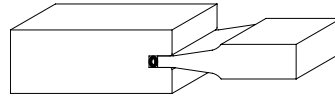

D11-131

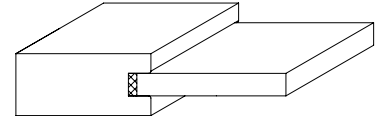

D13-403

## PANEL DOORS

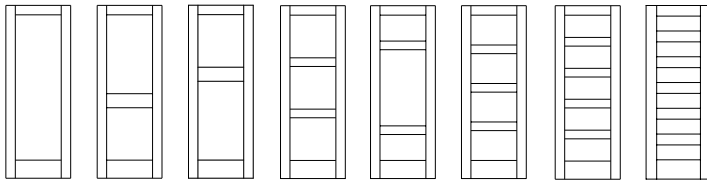

KW1000    KW2000    KW2030    KW3020    KW3080    KW4020    KW5020    KW6050

## LITED DOORS

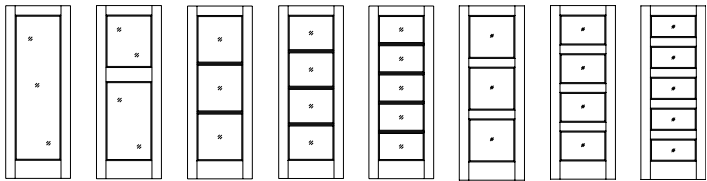

G01000    G02003    G03000    G04000    G05000    G03001    G04003    G05001







# CRAFTSMAN

RICH, CHARACTER AND TIMELESS APPEAL.

## Recommended Door Profile

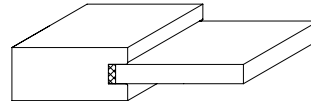

D13-403

## PANEL DOORS

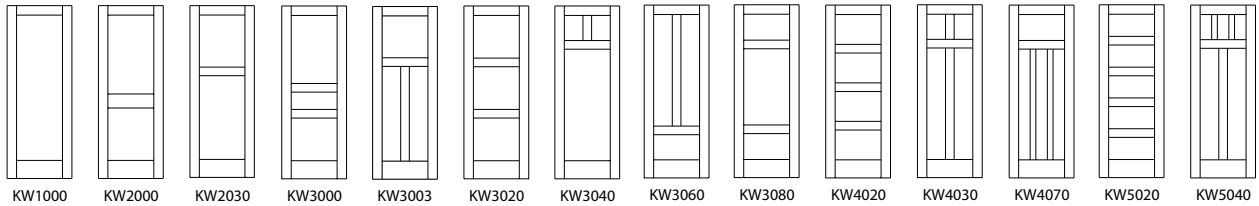

## LITED DOORS

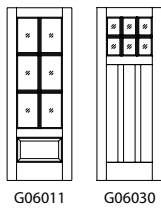





G03511CAP, w/ Custom Radius, KW Mahogany,  
Opal Glass, A-ADM Applied Moulding/261  
Panel, Custom Direct Set Transom



Courtesy - Loyd Builders, Apex, NC

# FRENCH COUNTRY

CASUAL ELEGANCE WITH NATURAL INFLUENCES.

## Recommended Door Profile

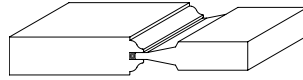

B11-341

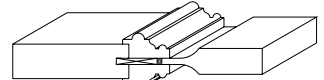

D11-241 with B-ADM applied moulding

## PANEL DOORS

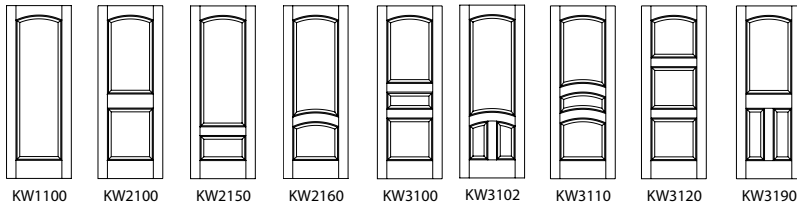

KW1100 KW2100 KW2150 KW2160 KW3100 KW3102 KW3110 KW3120 KW3190

## LITED DOORS

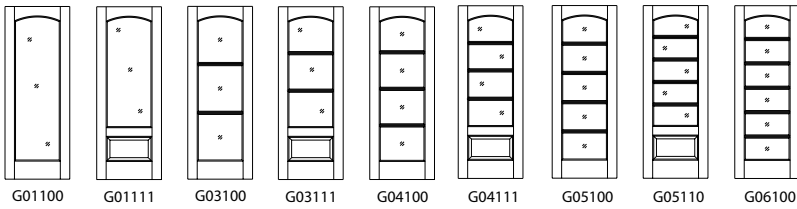

G01100 G01111 G03100 G03111 G04100 G04111 G05100 G05110 G06100

## ARCH TOP DOORS

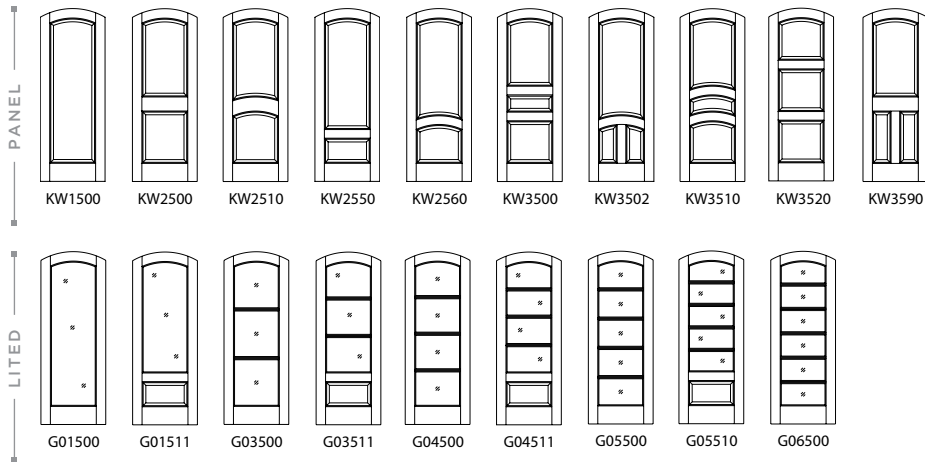

KW1500 KW2500 KW2510 KW2550 KW2560 KW3500 KW3502 KW3510 KW3520 KW3590

G01500 G01511 G03500 G03511 G04500 G04511 G05500 G05510 G06500









Courtesy - Loyd Builders, Apex, NC

# MEDITERRANEAN

BOLDNESS WITH SIMPLICITY AND WARMTH.

## Recommended Door Profile

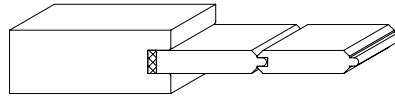

D13 w/ 16-DP-TVG

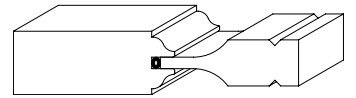

B11 / 241 Vee Groove

## PANEL DOORS

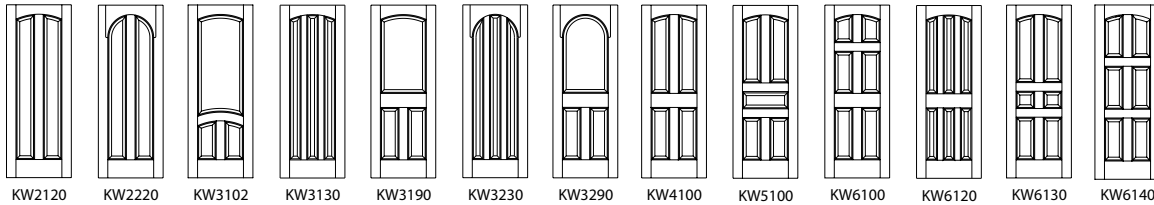

## LITED DOORS

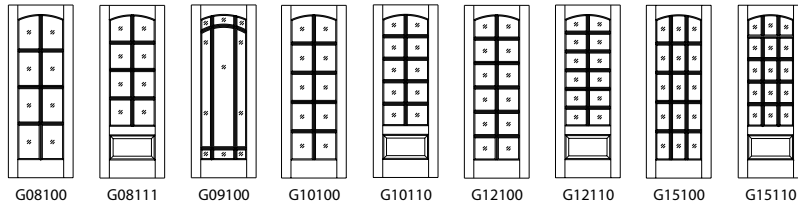

## ARCH TOP DOORS

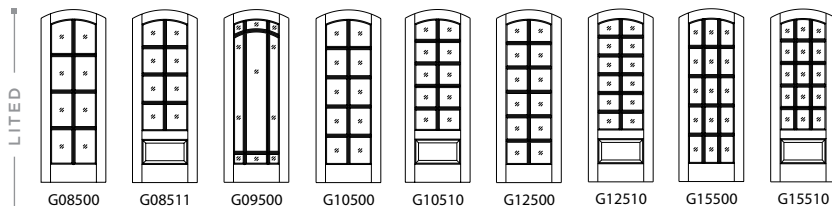

## HALF ROUND TOP DOORS

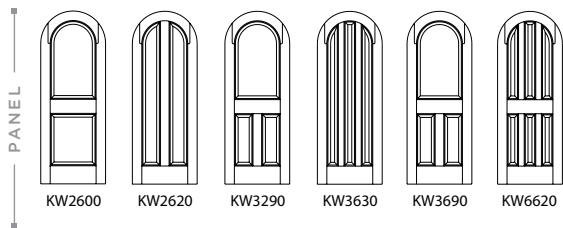





# MODERN FARMHOUSE

CLASSIC STYLE WITH A MODERN TOUCH.

## Recommended Door Profile

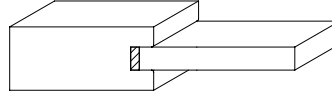

D13-403

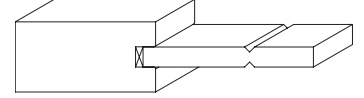

D13-403 Vee Groove

Courtesy - Loyd Builders, Apex, NC

## PANEL DOORS

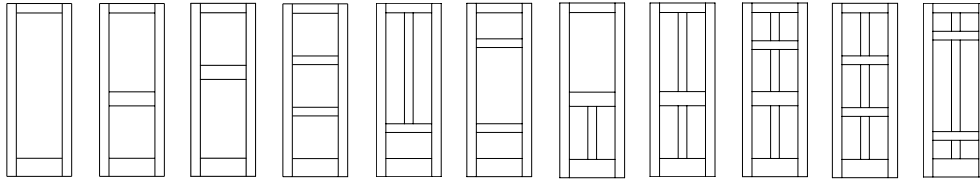

KW1000 KW2000 KW2030 KW3020 KW3060 KW3080 KW3090 KW4000 KW6000 KW6040 KW6060

## LITED DOORS

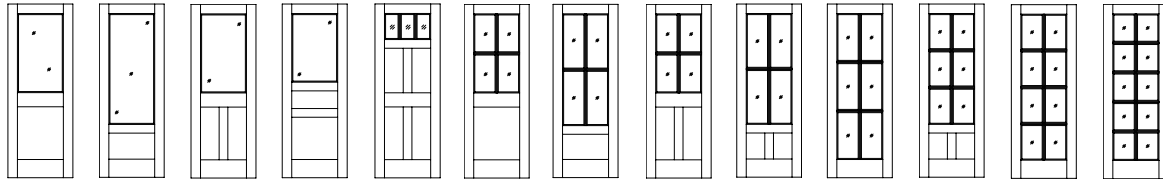

G01010 G01011 G01020 G01021 G03040 G04010 G04012 G04020 G04023 G06001 G06022 G08000 G10000

## BARN DOORS

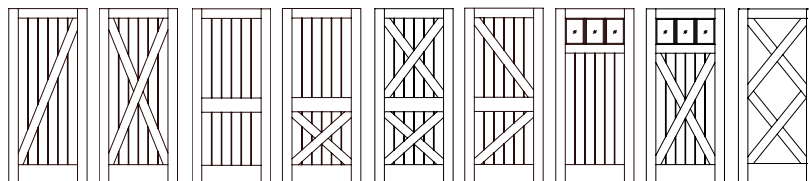

\*KB1000 \*KB1001 KB2000 \*KB2001 \*KB2002 \*KB2003 ZO3000 \*ZO3001 \*KB1002

\*Cross members are surface applied, flush with the face of the door. Available with "D" sticking only, flat panel designs.

See pages 38-41 for additional information on barn doors and barn door hardware.







# TUDOR

ELEGANT, OLD WORLD CHARM.

## Recommended Door Profile

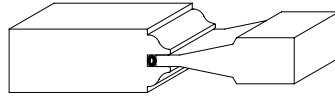

B11-341

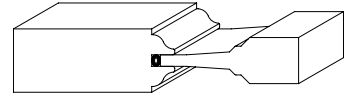

B11-641

## PANEL DOORS

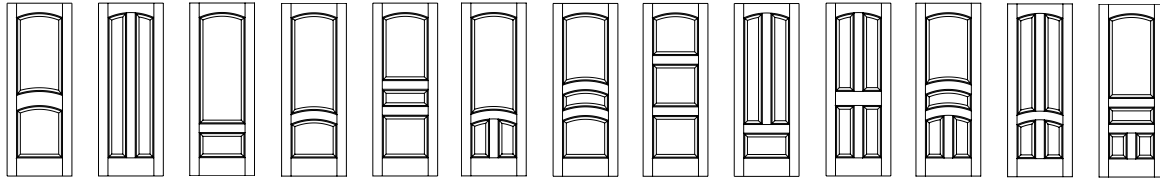

KW2110 KW2120 KW2150 KW2160 KW3100 KW3102 KW3110 KW3120 KW3160 KW4100 KW4101 KW4102 KW4103

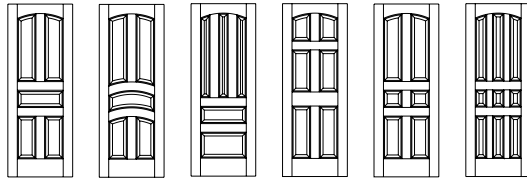

KW5100 KW5110 KW5170 KW6100 KW6130 KW9110

## LITED DOORS

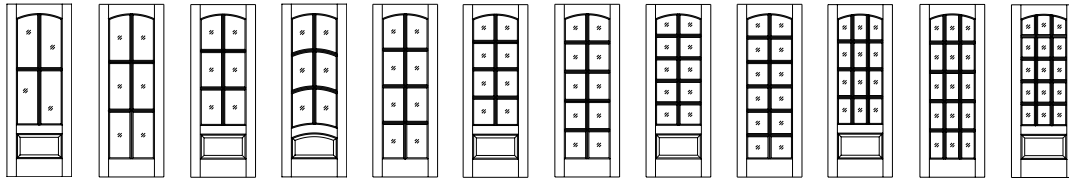

G04112 G06101 G06111 G06113 G08100 G08111 G10100 G10110 G12100 G12111 G15100 G15110

## ARCH TOP DOORS

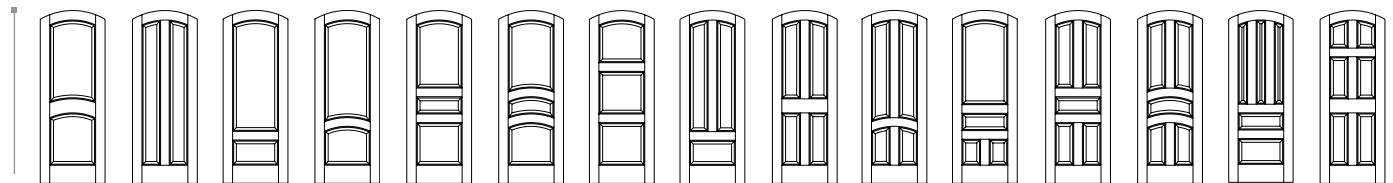

KW2510 KW2520 KW2550 KW2560 KW3500 KW3510 KW3520 KW3560 KW4500 KW4502 KW4503 KW5500 KW5510 KW5570 KW6500

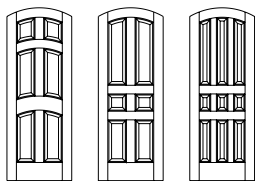

KW6510 KW6530 KW9510

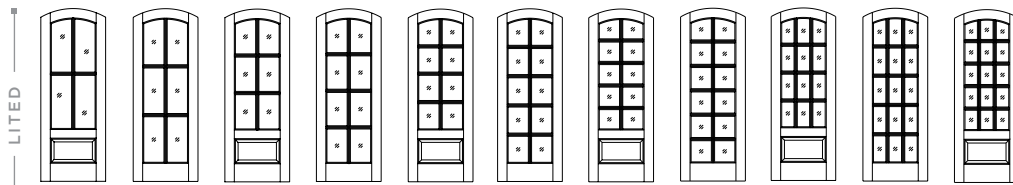

G04512 G06501 G06511 G08500 G08511 G10500 G10510 G12500 G12511 G15500 G15510









# TUSCAN

INSPIRED BY ELEMENTS OF NATURE.

## Recommended Door Profile

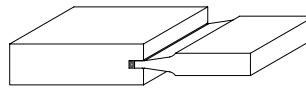

D11-131

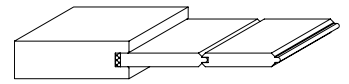

D13 with 1/2" T&V groove panel

## PANEL DOORS

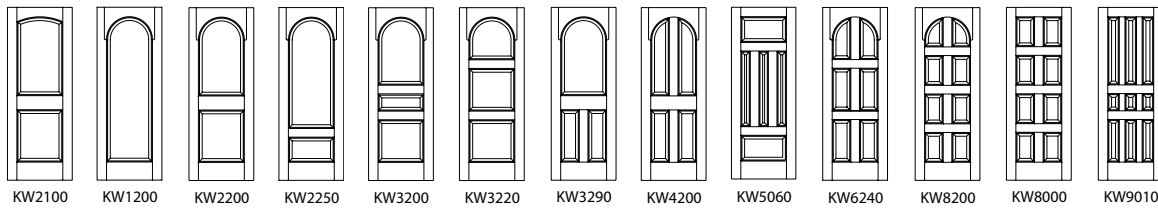

KW2100 KW1200 KW2200 KW2250 KW3200 KW3220 KW3290 KW4200 KW5060 KW6240 KW8200 KW8000 KW9010

## LITED DOORS

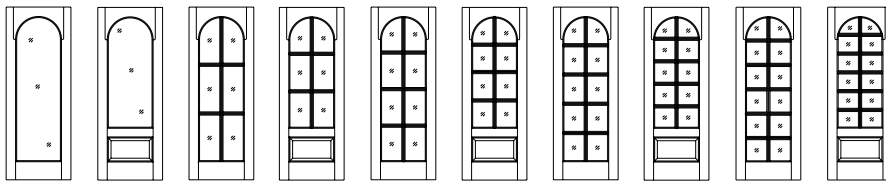

G01200 G01211 G06201 G06211 G08200 G08211 G10200 G10210 G12200 G12210

## HALF ROUND TOP DOORS

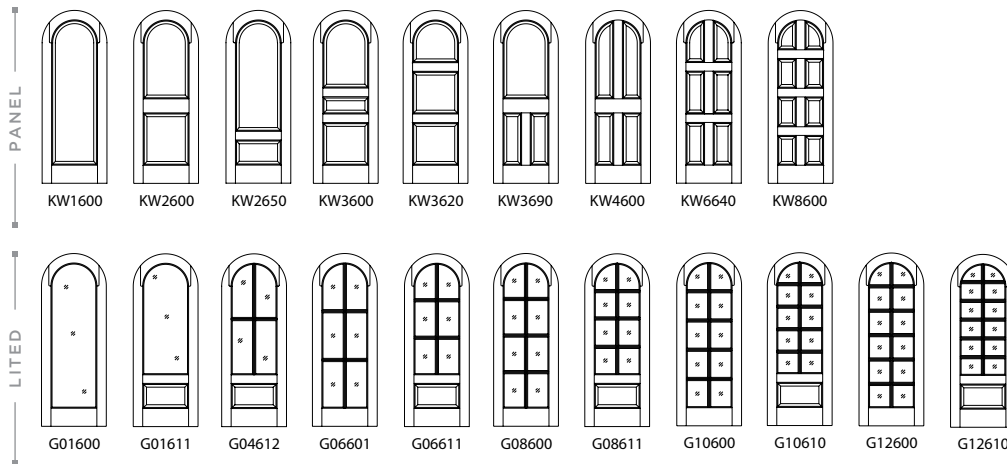

KW1600 KW2600 KW2650 KW3600 KW3620 KW3690 KW4600 KW6640 KW8600

G01600 G01611 G04612 G06601 G06611 G08600 G08611 G10600 G10610 G12600 G12610





# VICTORIAN

UNIQUE AND ABUNDANT WITH CHARACTER.

## Recommended Door Profile

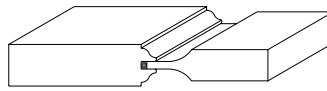

B11-241

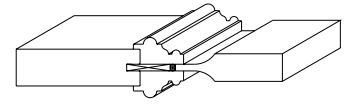

B-ADM 1" x 1-7/8" applied moulding

## PANEL DOORS

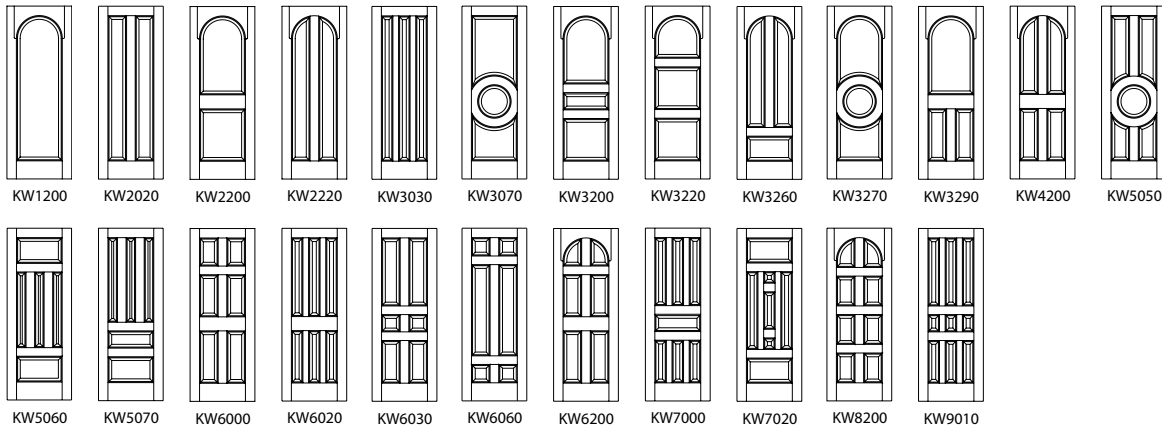

## LITED DOORS

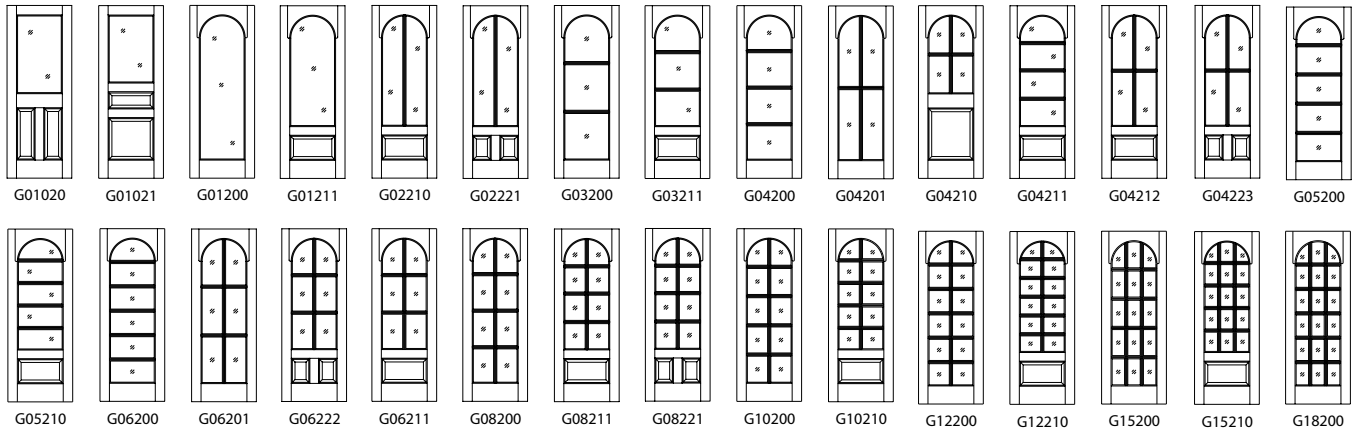

## HALF ROUND TOP DOORS

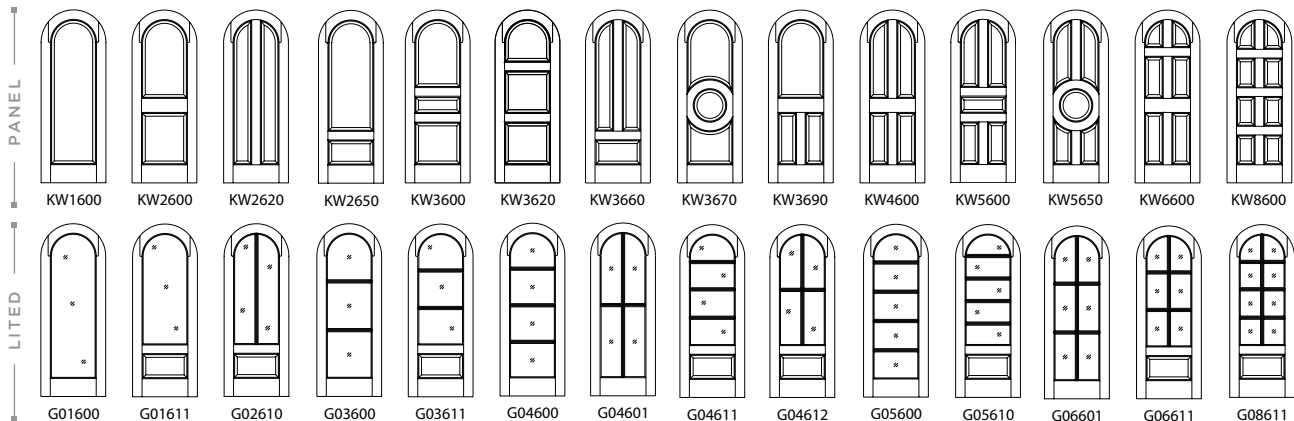



# REFERENCE GUIDE - PANEL DOORS

## 1-PANEL

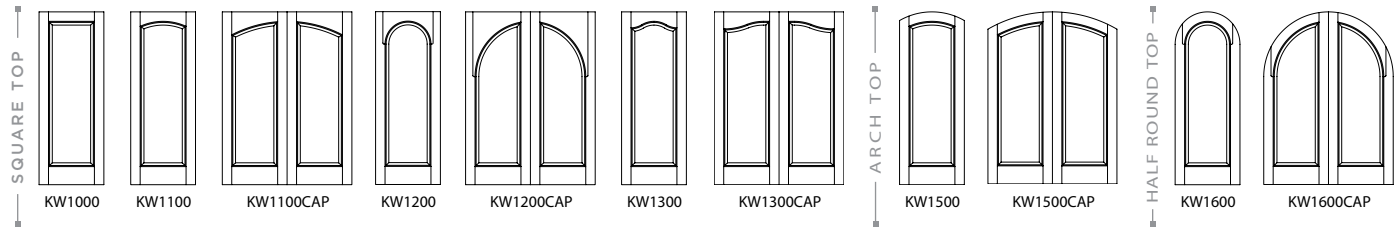

## 2-PANEL

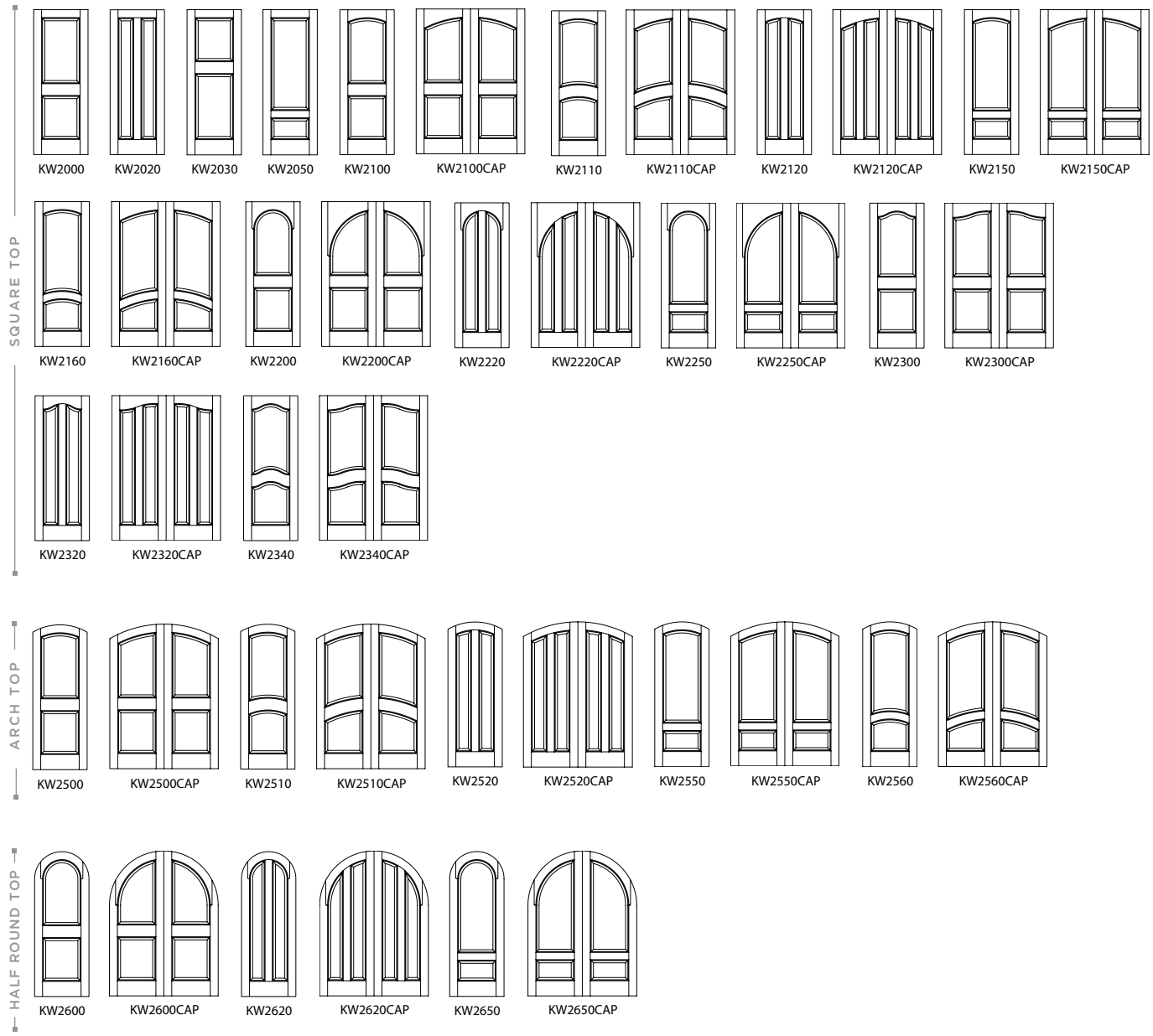

# REFERENCE GUIDE - PANEL DOORS

## 3-PANEL

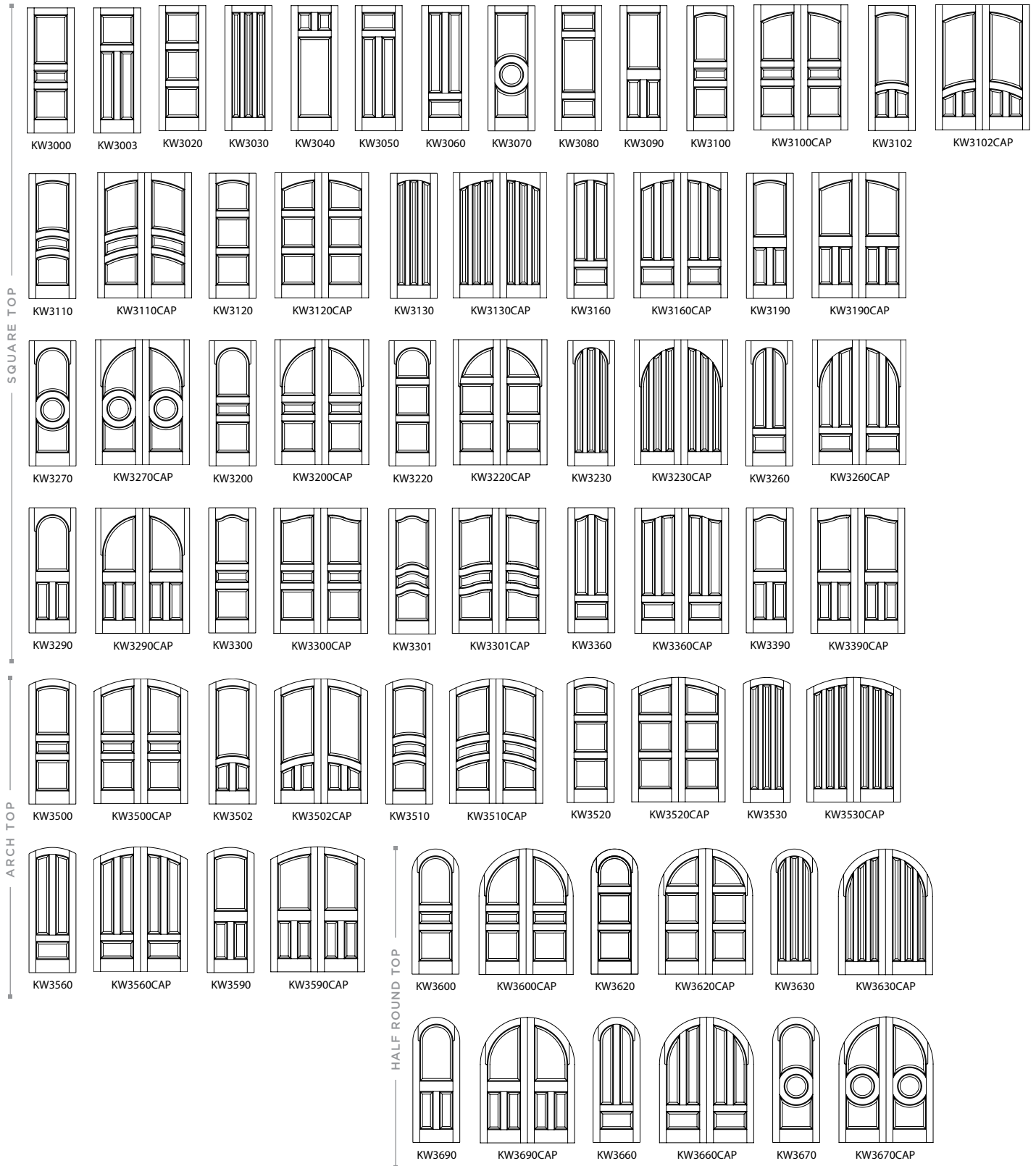

# REFERENCE GUIDE - PANEL DOORS

## 4-PANEL

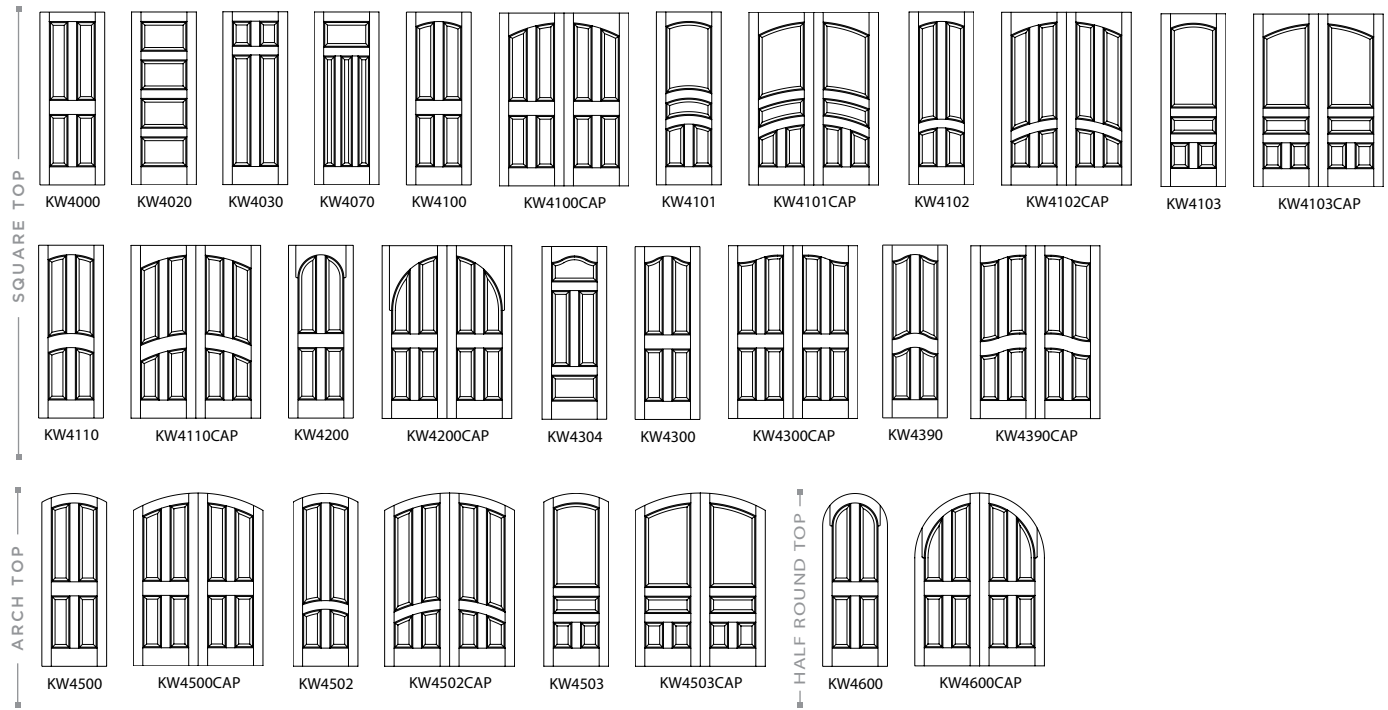

## 5-PANEL

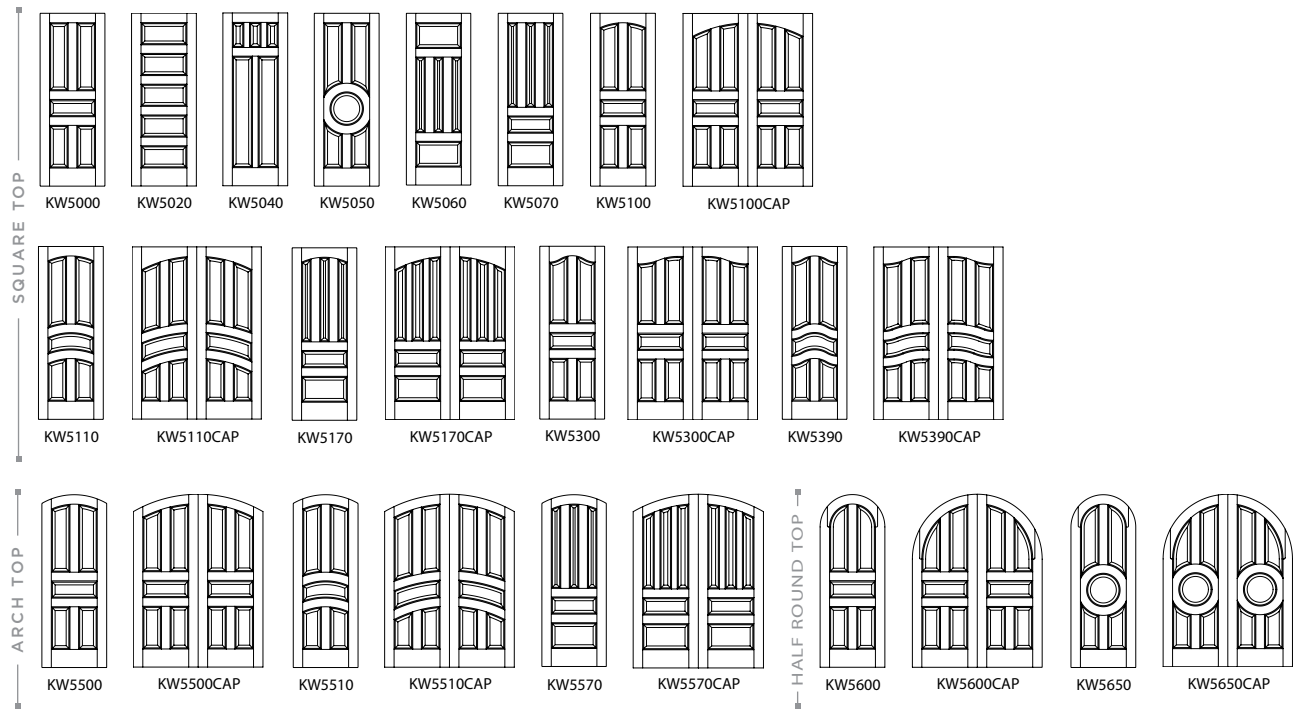

# REFERENCE GUIDE - PANEL DOORS

## 6-PANEL

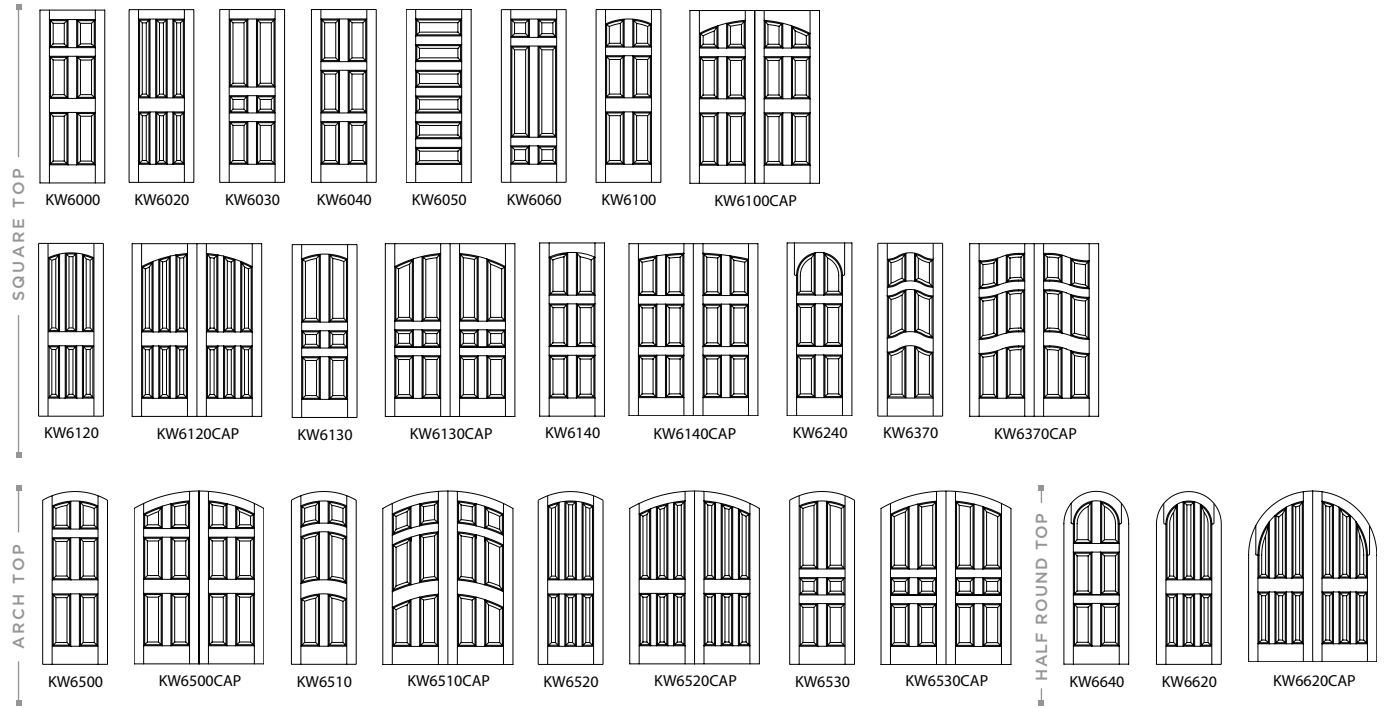

## 7-PANEL

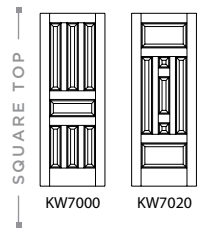

## 8-PANEL



## 9-PANEL

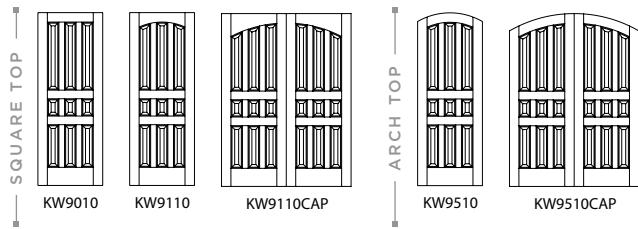

KW8000, D23-403, White Oak



# LOUVER AND DUTCH DOORS

## LOUVER DOORS

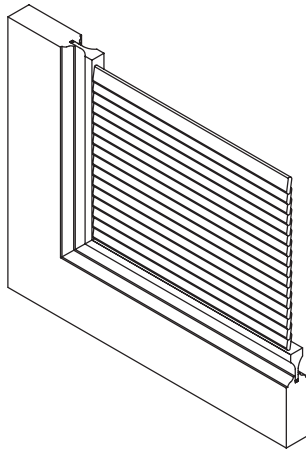
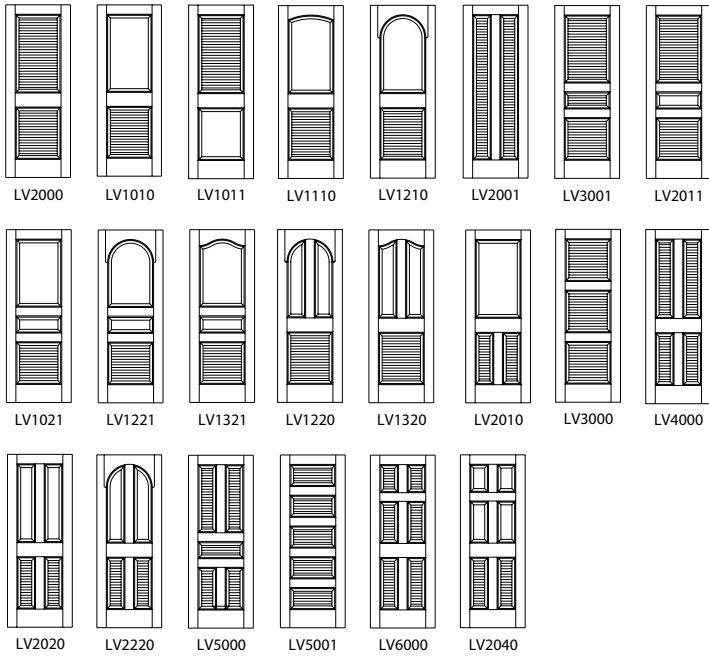

(From L to R) LV2000, LV2001 Poplar

Our louvered doors are manufactured with a unique raised panel louver design, where the louvers are set into a raised panel frame. Unlike traditional louver door construction, there is no end-play, which provides stability and eliminates rattles.

This method of construction offers you the ability to match your louvered door sticking and panel raise to your paneled doors, maintaining a consistent design throughout your project.

## DUTCH DOORS

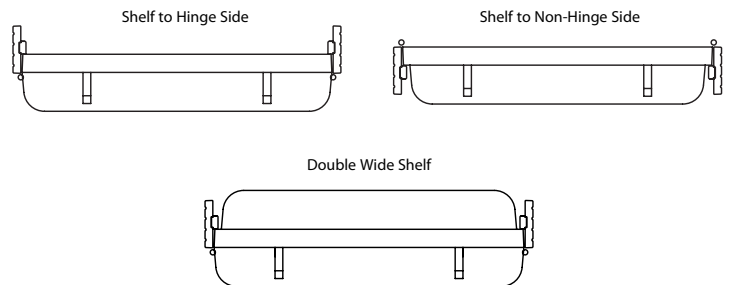

# 1-3/8" INTERIOR PANEL & RAIL OPTIONS

## 1-3/8" DOORS - PANEL RAIL COMBINATIONS - 1/4" GROOVE

Images are shown at 35% of size.

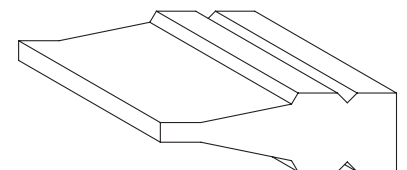
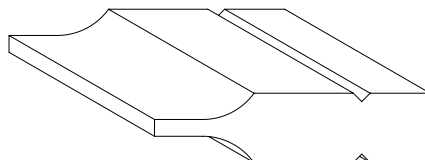
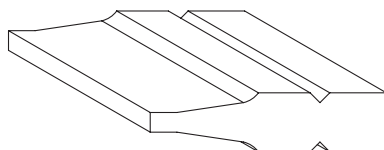
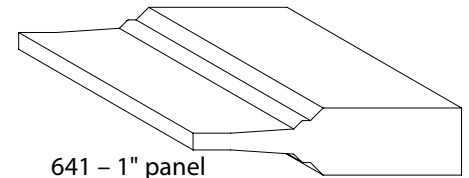
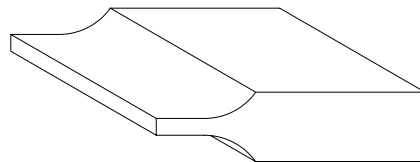
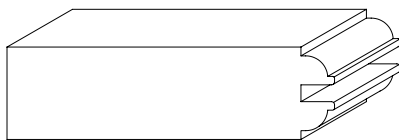
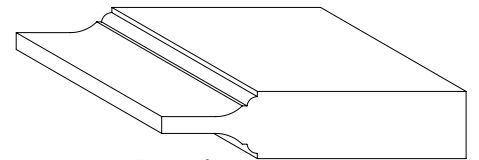
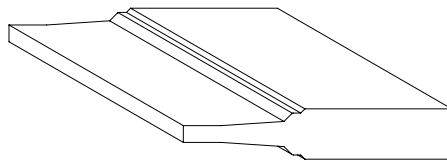
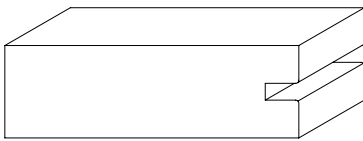
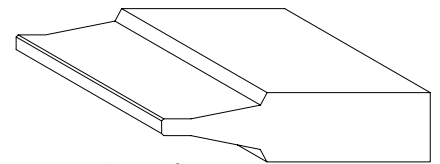
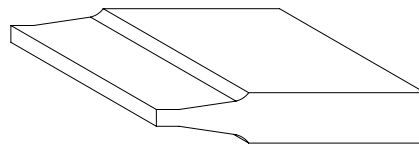
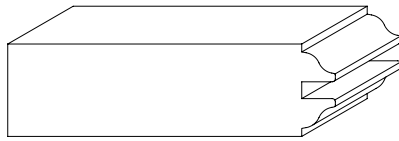
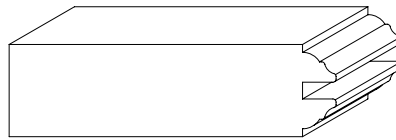
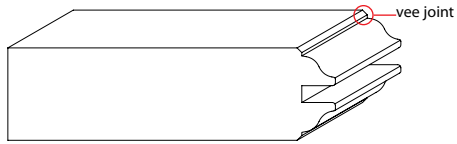

# 1-3/8" INTERIOR PANEL & RAIL OPTIONS

## 1-3/8" DOORS - PANEL RAIL COMBINATIONS - 1/2" GROOVE

Images are shown at 35% of size.

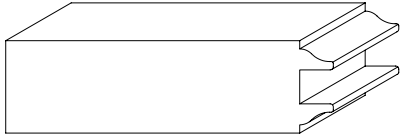

B13

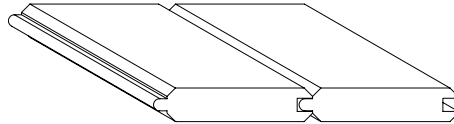

16-DP-TVG, 1/2" T&V Groove  
(Plank width varies based on door style)

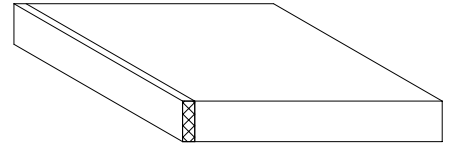

403 - 1/2" Flat Panel  
Panel may be veneer or solid

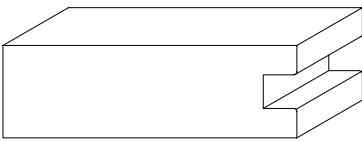

D13

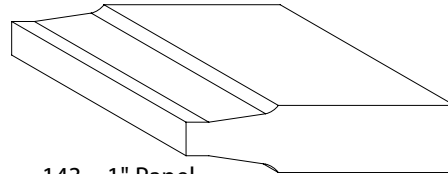

143 - 1" Panel

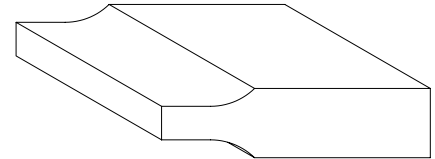

243 - 1" Panel

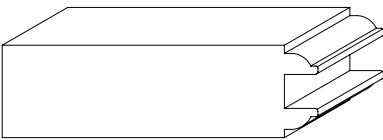

E13

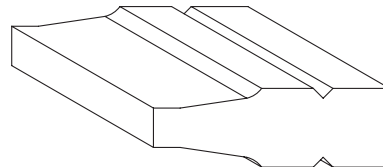

143 Vee Groove - 1" panel  
1/4" w. x 1/8" d. vee groove

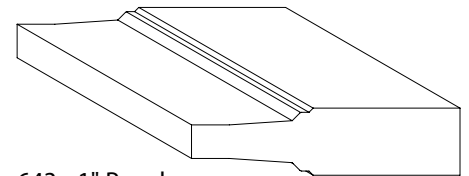

643 - 1" Panel

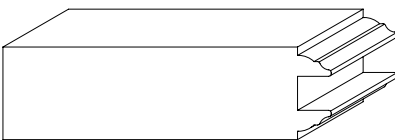

F13

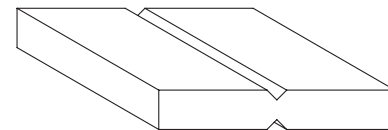

403 Vee Groove - 1/2" panel  
1/4" w. x 1/8" d. vee groove

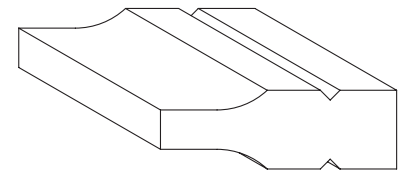

243 Vee Groove - 1" panel  
1/4" w. x 1/8" d. vee groove

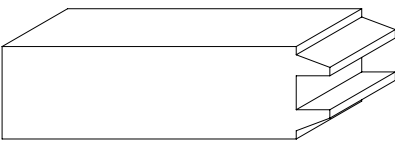

G13

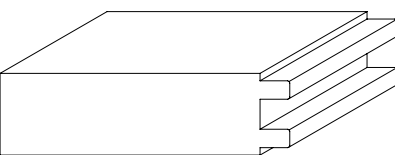

H13



# 1-3/4" INTERIOR PANEL & RAIL OPTIONS

## 1-3/4" DOORS - PANEL RAIL COMBINATIONS - 1/4" GROOVE

Images are shown at 35% of size.

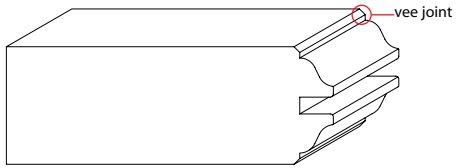

A21

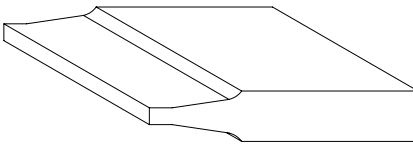

131 - 3/4" panel

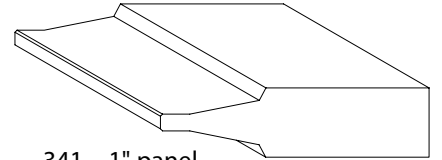

341 - 1" panel

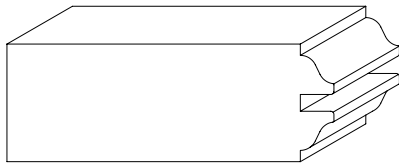

B21

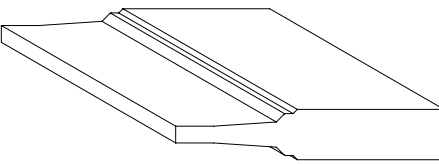

631 - 3/4" panel

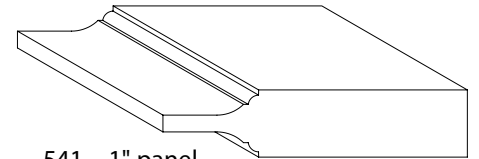

541 - 1" panel

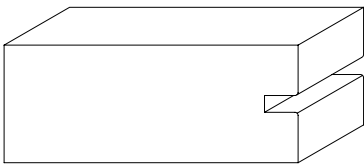

D21

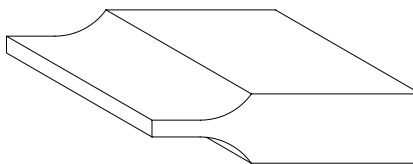

241 - 1" panel

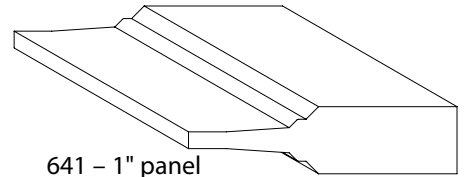

641 - 1" panel

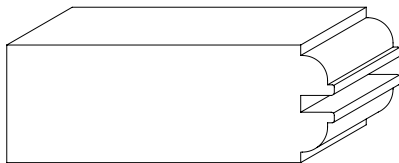

E21

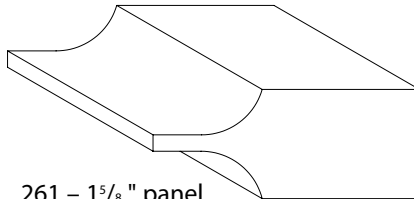

261 - 1<sup>5</sup>/<sub>8</sub>" panel

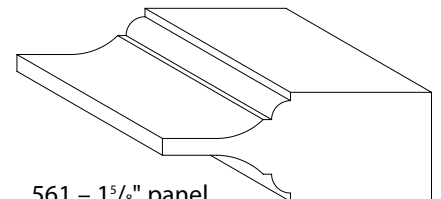

561 - 1<sup>5</sup>/<sub>8</sub>" panel

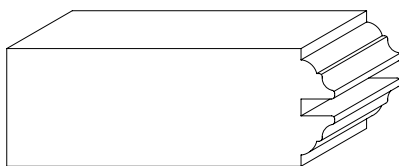

F21

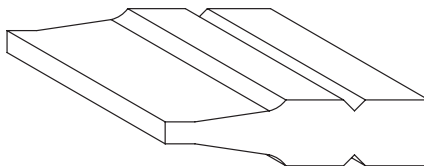

131 Vee Groove - 3/4" panel  
1/4" w. x 1/8" d. vee groove

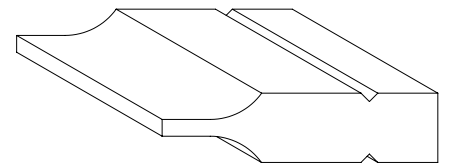

241 Vee Groove - 1" panel  
1/4" w. x 1/8" d. vee groove

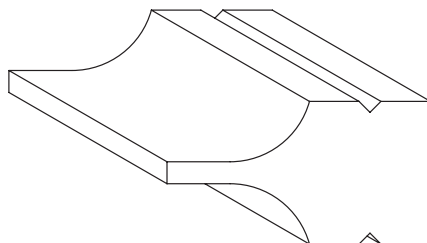

261 Vee Groove - 1<sup>5</sup>/<sub>8</sub>" panel  
1/4" w. x 1/8" d. vee groove

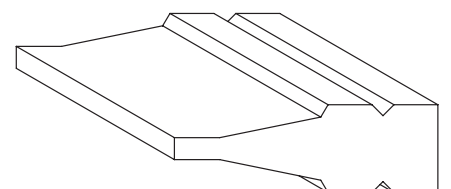

341 Vee Groove - 1" panel  
1/4" w. x 1/8" d. vee groove

# 1-3/4" INTERIOR PANEL & RAIL OPTIONS

## 1-3/4" DOORS - PANEL RAIL COMBINATIONS - 1/2" GROOVE

Images are shown at 35% of size.

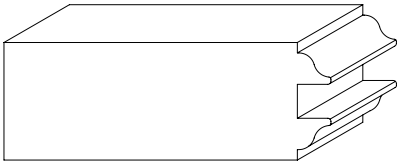

B23

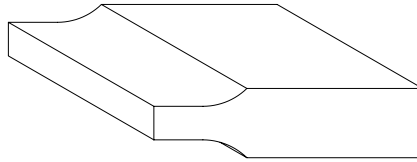

243 - 1" Panel

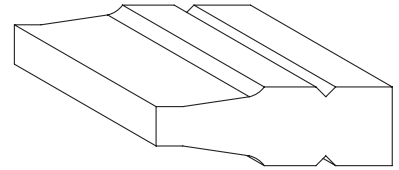

143 Vee Groove - 1" panel  
1/4" w. x 1/8" d. vee groove

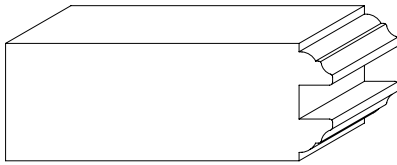

F23

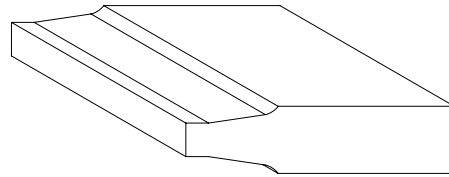

143 - 1" Panel

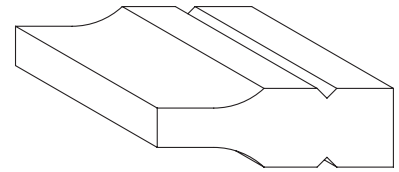

243 Vee Groove - 1" panel  
1/4" w. x 1/8" d. vee groove

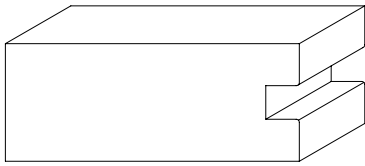

D23

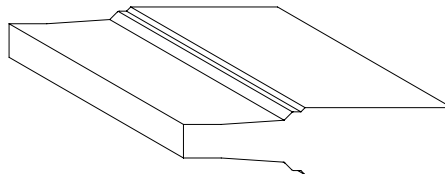

643 - 1" Panel

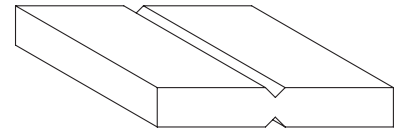

403 Vee Groove - 1/2" panel  
1/4" w. x 1/8" d. vee groove

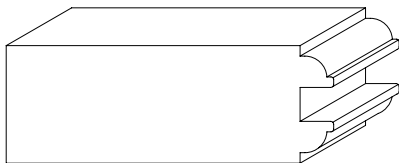

E23

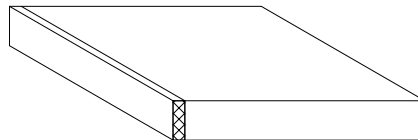

403 - 1/2" Flat Panel  
Panel may be veneer or solid

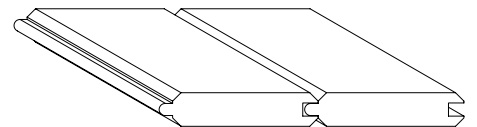

1/2" T&V Groove  
(Plank width varies based on door style)

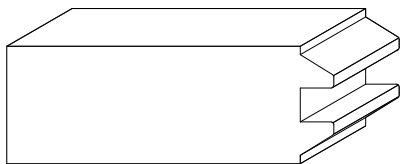

G23

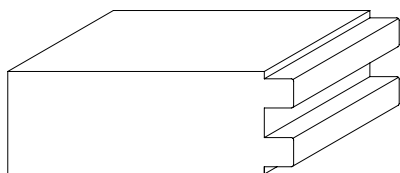

H23

# 1-3/4" EXTERIOR PANEL & RAIL OPTIONS

## 1-3/4" DOORS - PANEL RAIL COMBINATIONS - 5/8" GROOVE

Images are shown at 35% of size.

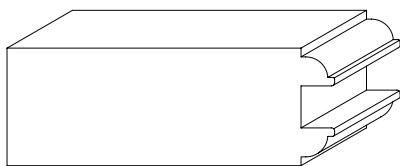
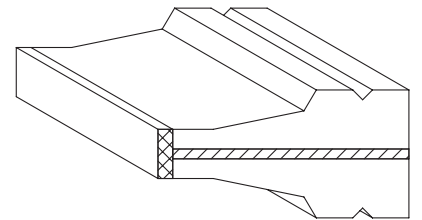
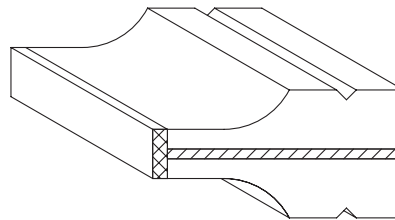
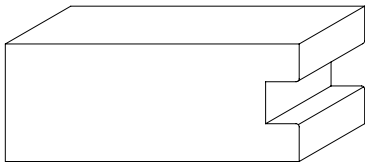
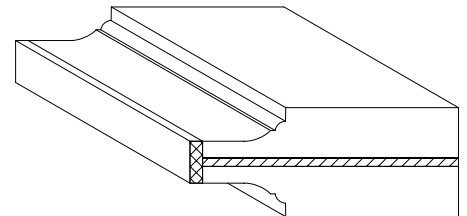
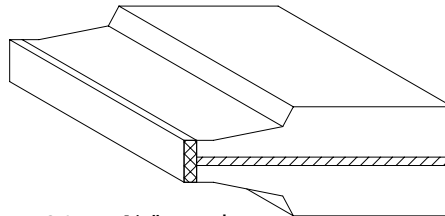
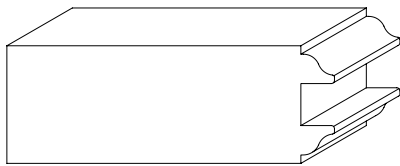
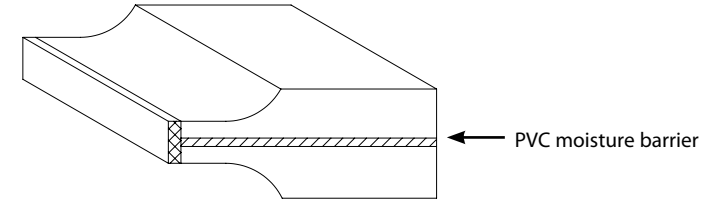
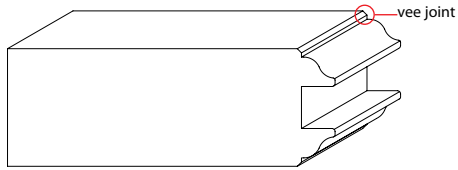

## 1-3/4" DOORS - PANEL RAIL COMBINATIONS - 1" GROOVE

Images are shown at 35% of size.

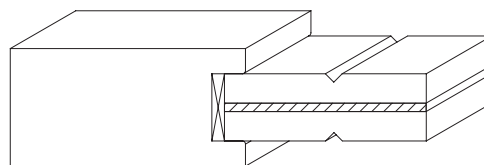
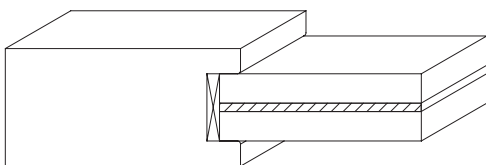



# 2-1/4" INTERIOR PANEL & RAIL OPTIONS

## 2-1/4" DOORS - PANEL RAIL COMBINATIONS - 1/4" GROOVE

Images are shown at 35% of size.

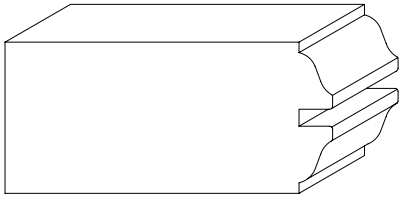

B51

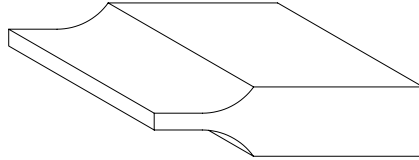

241 - 1" panel

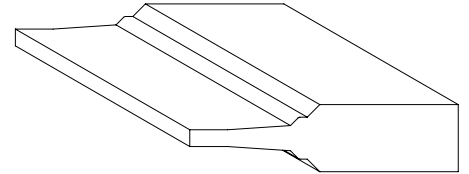

641 - 1" panel

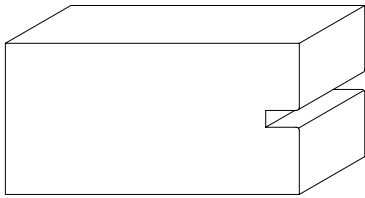

D51

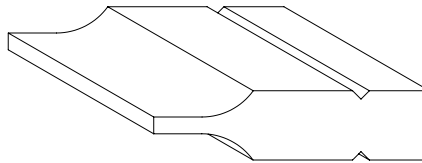

241 Vee Groove - 1" panel  
1/4" w. x 1/8" d. vee groove

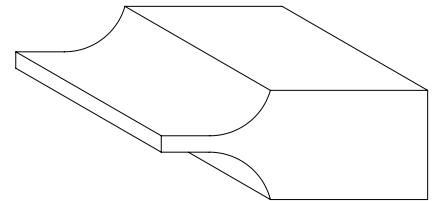

261 - 1 5/8" panel

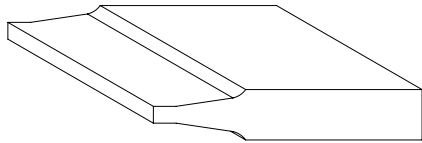

131 - 3/4" panel

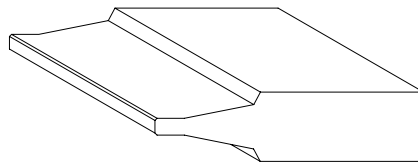

341 - 1" panel

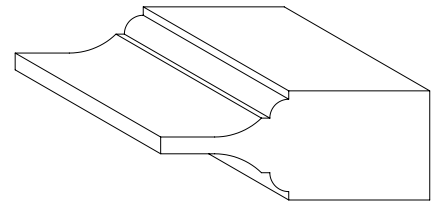

561 - 1 5/8" panel

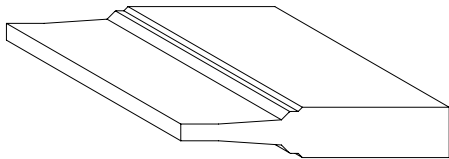

631 - 3/4" panel

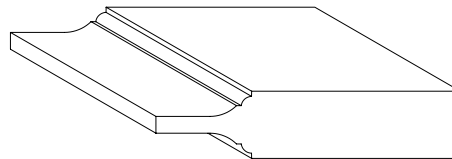

541 - 1" panel

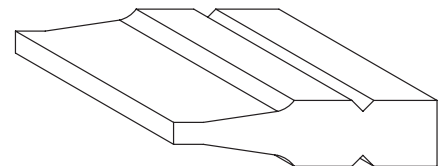

131 Vee Groove - 3/4" panel  
1/4" w. x 1/8" d. vee groove

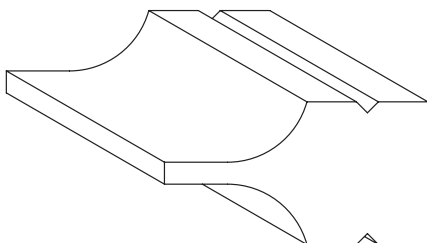

261 Vee Groove - 1 5/8" panel  
1/4" w. x 1/8" d. vee groove

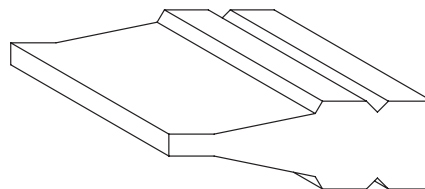

341 Vee Groove - 1" panel  
1/4" w. x 1/8" d. vee groove

# 2-1/4" EXTERIOR PANEL & RAIL OPTIONS

## 2-1/4" DOORS - PANEL RAIL COMBINATIONS - 3/4" GROOVE

Images are shown at 35% of size.

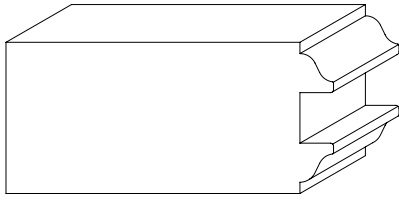

B55

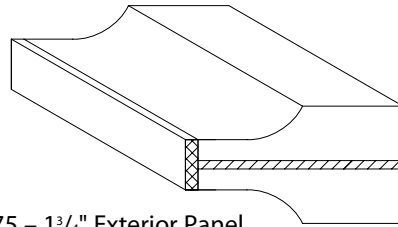

275 - 1<sup>3</sup>/<sub>4</sub>" Exterior Panel

← PVC moisture barrier

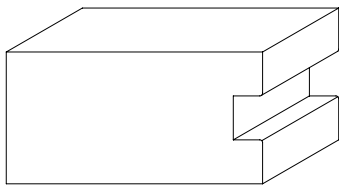

D55

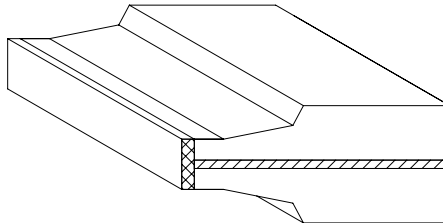

375 - 1<sup>3</sup>/<sub>4</sub>" Panel

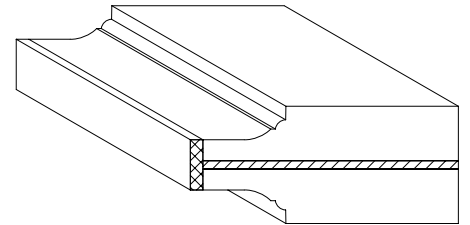

575 - 1<sup>3</sup>/<sub>4</sub>" Panel

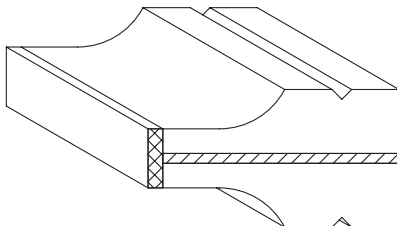

275 Vee Groove - 1<sup>3</sup>/<sub>4</sub>" panel  
1/4" w. x 1/8" d. vee groove

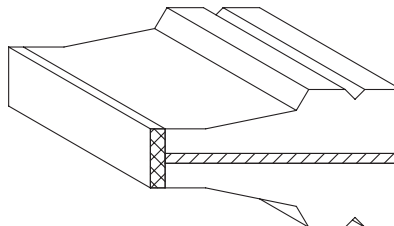

375 Vee Groove - 1<sup>3</sup>/<sub>4</sub>" panel  
1/4" w. x 1/8" d. vee groove

## 2-1/4" DOORS - PANEL RAIL COMBINATIONS - 1" GROOVE

Images are shown at 35% of size.

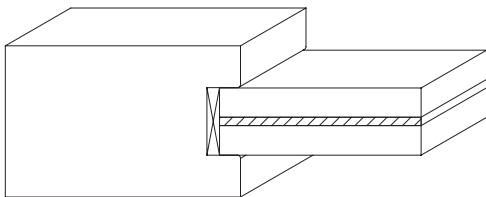

D57-447 - 1" panel

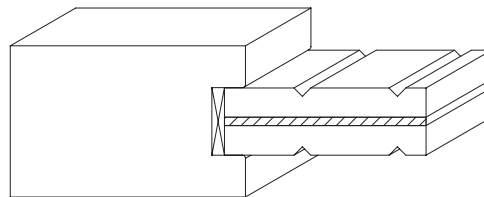

D57-447 Vee Groove - 1" panel  
1/4" w. x 1/8" d. vee groove

# APPLIED MOULDING OPTIONS

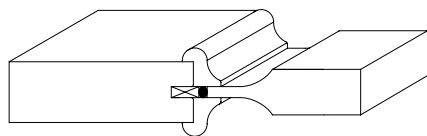

A-ADM  $\frac{7}{8}$ " x  $\frac{7}{8}$ " applied moulding

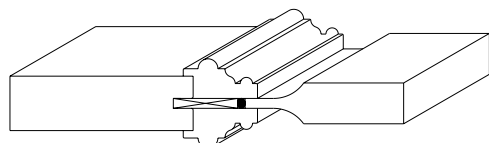

B-ADM 1" x  $1\frac{7}{8}$ " applied moulding

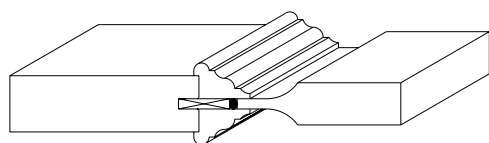

D-ADM  $\frac{7}{8}$ " x  $1\frac{3}{8}$ " applied moulding

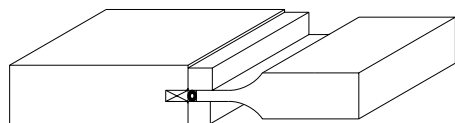

G-ADM  $\frac{1}{2}$ " x  $\frac{1}{2}$ " applied moulding

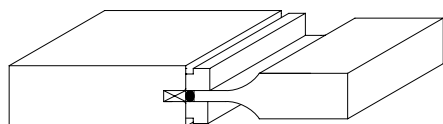

I-ADM  $\frac{1}{2}$ " x  $\frac{1}{2}$ " applied moulding

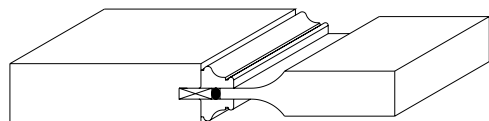

J-ADM  $\frac{1}{2}$ " x  $\frac{3}{4}$ " applied moulding



KW3060, 561 panel with B-ADM applied moulding, S01010 Sidelite (custom rail placement), Rain glass, Poplar

Add a unique design element to your hardwood doors by choosing from our wide selection of applied moulding options.

Most mouldings can be modified to fit based on your individual door style and rail/panel selection (some limitations apply.) For illustration purposes, all applied mouldings are shown in combination with 1-3/8" rails and the 241 panel. Actual moulding size may vary based on your particular panel and rail selection.





# SIGNATURE PRIME™ DOORS



When your project calls for paint grade doors, rely on the quality and craftsmanship found in Signature Prime™ doors.

Poplar stiles and rails combined with MDF panels are the perfect combination. Signature Prime™ doors feature face laminated, solid Poplar stiles and rails, providing superior screw holding power and reduced hinge wear over the life of the door. Since wood moves with the grain, the greatest expansion and contraction occurs in the widest components – the panels. MDF does not have grain memory, so it expands and contracts equal amounts in width and length, providing greater stability and uniform structural support.

The detailing in a Signature Prime™ door is visibly evident. Profiles are precision machined with diamond and carbide tooling, providing crisp, well-defined profile features. Each door is primed by hand with a high-solid content primer which provides more thorough coverage, while maintaining the precise detail of the profile.



Shown: D13-403



Shown: B11-241

# FIRE RATED STILE AND RAIL WOOD DOORS



Interior Wood Products offers an unmatched selection of fire rated stile and rail doors, engineered to match our extensive offering of non-rated doors. Choose from numerous panel and rail options in one of nine highly recognized architectural styles. Doors are available as slabs or pre-hung units in accompanying fire rated wood jambs.

## ADDITIONAL INFORMATION REGARDING FIRE DOOR AVAILABILITY:

	20-minute	45-minute	60-minute	90-minute
<b>Category</b>	Category A Positive Pressure or Category B Neutral Pressure	Category A Positive Pressure or Category B Neutral Pressure	Category A Positive Pressure or Category B Neutral Pressure	Category A Positive Pressure or Category B Neutral Pressure
<b>Thickness</b>	1-3/4" or 2-1/4"	1-3/4" or 2-1/4"	1-3/4" or 2-1/4"	1-3/4" or 2-1/4"
<b>Door Species</b>	Alder, Knotty Alder, Cherry, Fir, Hard Maple, Hickory, KW Mahogany, Poplar (Raw, Primed, or with MDF panels*), Red Oak, Walnut, White Oak	Alder, Knotty Alder, Cherry, Fir, Hard Maple, Hickory, KW Mahogany, Poplar (Raw, Primed, or with MDF panels*), Red Oak, Walnut, White Oak	Alder, Knotty Alder, Cherry, Fir, Hard Maple, Hickory, KW Mahogany, Poplar (Raw, Primed, or with MDF panels*), Red Oak, Walnut, White Oak	Alder, Knotty Alder, Cherry, Fir, Hard Maple, Hickory, KW Mahogany, Poplar (Raw, Primed, or with MDF panels*), Red Oak, Walnut, White Oak
<b>Door Styles</b>	Square or Radius Top Panel Doors	Square or Radius Top Panel Doors	Square or Radius Top Panel Doors	Square top panel doors only
<b>Maximum Door Width</b>	4'0" Singles 7'0" Pairs	4'0" Singles	4'0" Singles	4'0" Singles
<b>Maximum Door Height</b>	8'0"	8'0"	8'0"	8'0"
<b>Hanging</b>	Available pre-hung in 20 minute wood jambs** Radius Top Doors Require a 45/60 Min jamb	Available pre-hung in 45 minute Fire Core wood jambs ** Single pre-hungs only	Available pre-hung in 60 minute Fire Core wood jambs ** Single pre-hungs only	Available pre-hung in 90 minute Fire Core wood jambs ** Single pre-hungs only
<b>Low Density Jamb Species</b>	Alder, Cherry, Fir, Knotty Alder & Poplar Maximum Size Singles 3'6" X 8'0" Doubles 5'6" X 8'0"	Alder, Knotty Alder, Cherry, Fir, Hard Maple, Hickory, KW Mahogany, Poplar, Red Oak, Walnut & White Oak	Alder, Knotty Alder, Cherry, Fir, Hard Maple, Hickory, KW Mahogany, Poplar, Red Oak, Walnut & White Oak	Alder, Knotty Alder, Cherry, Fir, Hard Maple, Hickory, KW Mahogany, Poplar, Red Oak, Walnut & White Oak
<b>High Density Jamb Species</b>	Hard Maple, Hickory, KW Mahogany, Red Oak, Walnut & White Oak Maximum Size Singles 4'0" X 8'0"** Doubles 7'0" X 8'0"**	Singles Only 4'0" X 8'0"	Singles Only 4'0" X 8'0"	Singles Only 4'0" X 8'0"

\* MDF flat panels not available.

\*\* Call for information in jamb and hang limitations. Some restrictions apply.





# BARN DOORS & BARN DOOR HARDWARE

## BARN DOOR STYLES

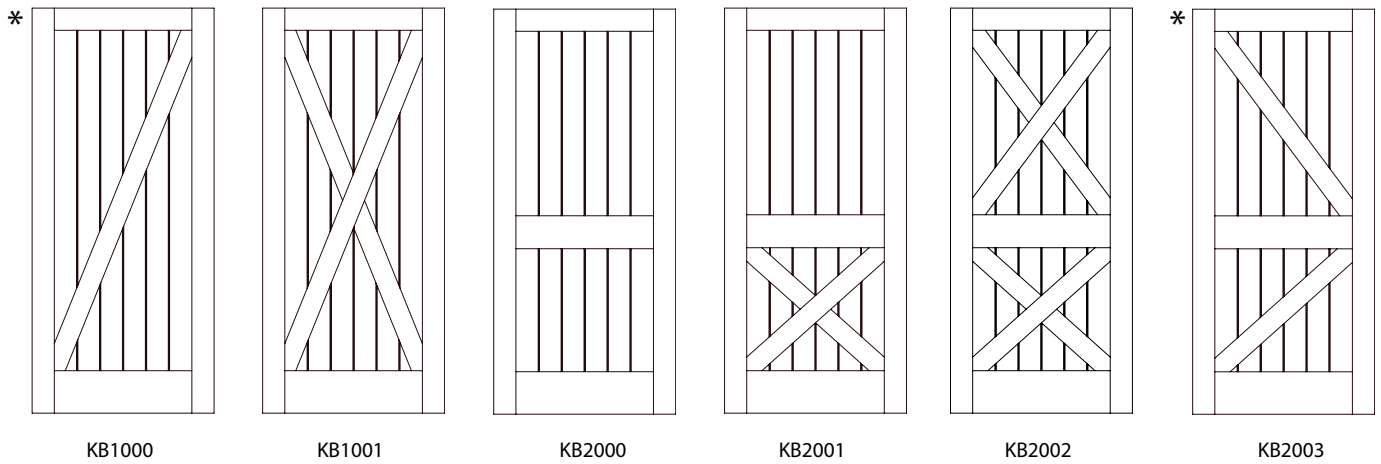

\* - Designates hinge side on pre-hung units

## LITED BARN DOOR STYLES

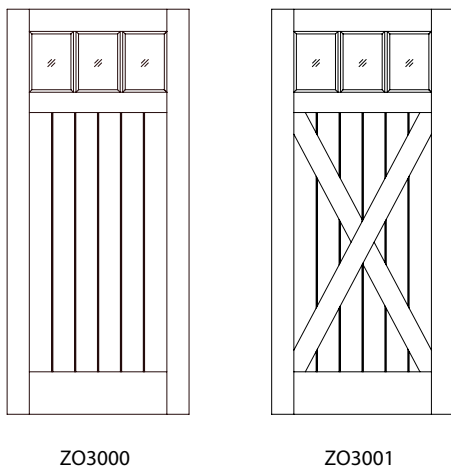

Additional door styles available upon request.



KW2000, Knotty Alder, J-ADM/341 v-groove (custom v-groove placement)

## 1-3/8" RAIL & PANEL/GLASS COMBINATIONS

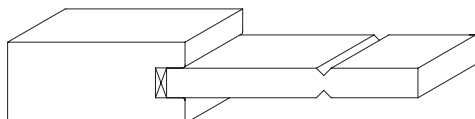

D13-403 vee groove panel

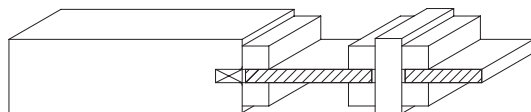

D1G with 1/4" glass

Cross members are surface applied, flush with the face of the door.

## 1-3/4" RAIL & PANEL/GLASS COMBINATIONS

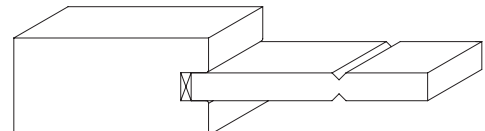

D23-403 vee groove panel

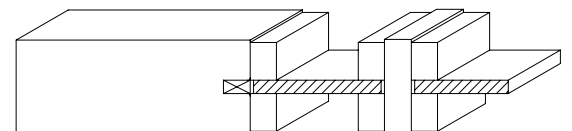

D2G with 1/4" glass

Cross members are surface applied, flush with the face of the door.





# BARN DOORS & BARN DOOR HARDWARE

## PRODUCT SPECIFICATIONS

- Choose from three popular styles, including straight strap, bent strap, and top of door strap.
- Stocked in three factory finishes - Matte Black, Bronze, and Satin Nickel.
- Hardware designed for both 1-3/8" and 1-3/4" thick doors, weighing up to 250 lbs.
- Kits include 96" track width, door straps, all mounting hardware, and floor guides.
- Perfect for closets, room dividers or passage door applications.
- Additional accessories available, including a selection of replacement hardware components as well as privacy locks and track connectors for bi-parting door applications.
- Ideal for openings 34" - 44" in width.

### FINISH CODES

BR - Bronze  
MB - Matte Black  
SN - Satin Nickel



#### STRAIGHT STRAP HARDWARE KIT

HDW BD100K-09600-SN (shown)  
HDW BD100K-09600-MB  
HDW BD100K-09600-BR



#### TOP OF DOOR HARDWARE KIT

HDW BD101K-09600-SN  
HDW BD101K-09600-MB  
HDW BD101K-09600-BR (shown)



#### BENT STRAP HARDWARE KIT

HDW BD102K-09600-SN  
HDW BD102K-09600-MB (shown)  
HDW BD102K-09600-BR



#### REPLACEMENT STRAP - BENT

HDW BD552-BR (shown)  
HDW BD552-MB  
HDW BD552-SN



#### REPLACEMENT STRAP - STRAIGHT

HDW BD550-BR (shown)  
HDW BD550-MB  
HDW BD550-SN



#### BARN DOOR TRACK ONLY - 96"

HDW BD5000-09600-BR  
HDW BD5000-09600-MB (shown)  
HDW BD5000-09600-SN



#### TRACK JOINER KIT

HDW BD125-BR (shown)  
HDW BD125-MB  
HDW BD125-SN



#### BARN DOOR LAG SCREW

For Wall Spacers  
HDW BD136-MB (shown)  
HDW BD136-SN



#### FLOOR MOUNT GUIDES (PAIR)

HDW BD750  
(black only - for non-grooved doors)



#### FLOOR MOUNT GUIDE

HDW BD750  
(black only - bottom of door must be grooved)



#### BARN DOOR LATCH

HDW BD250-BR (shown)  
HDW BD250-MB  
HDW BD250-SN



#### TRACK STOPS (Left or Right)

HDW BD850-BR-L  
HDW BD850-BR-R  
HDW BD850-MB-L  
HDW BD850-MB-R  
HDW BD850-SN-L  
HDW BD850-SN-R



#### BARN DOOR STRAP BOLT

HDW BD130-MB (for 1-3/8" door)  
HDW BD130-SN (for 1-3/8" door)  
HDW BD133-MB (for 1-3/4" door)  
HDW BD133-SN (for 1-3/4" door)



#### EASY CLIP SOFT CLOSE ACCESSORY

HDW BDF960-6085-MB (black only)



#### WALL SPACER

HDW BD350-BR (shown)  
HDW BD350-MB  
HDW BD350-SN



#### ADJUSTABLE WALL MOUNT GUIDE

HDW BDWMGUIDE-MB  
(black only - bottom of door must be grooved)



#### ANTI JUMP BLOCKS

HDW BD790 (pair)



# REFERENCE GUIDE - LITED DOORS

## 1-LITE

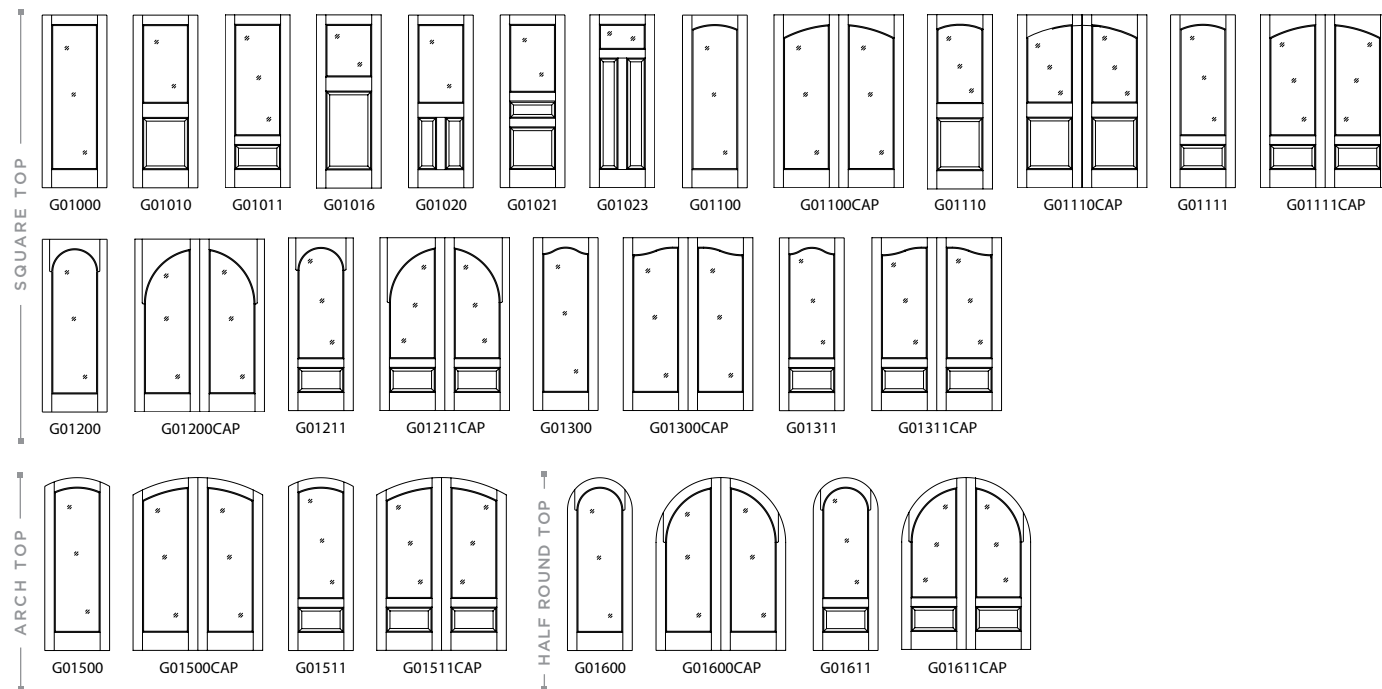

## 2-LITE

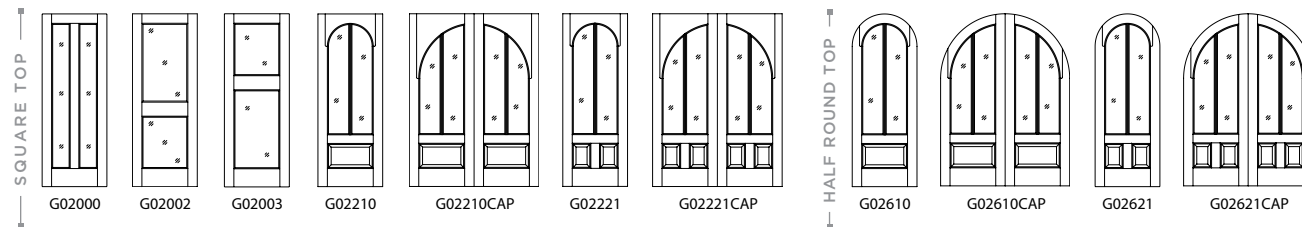

## 3-LITE

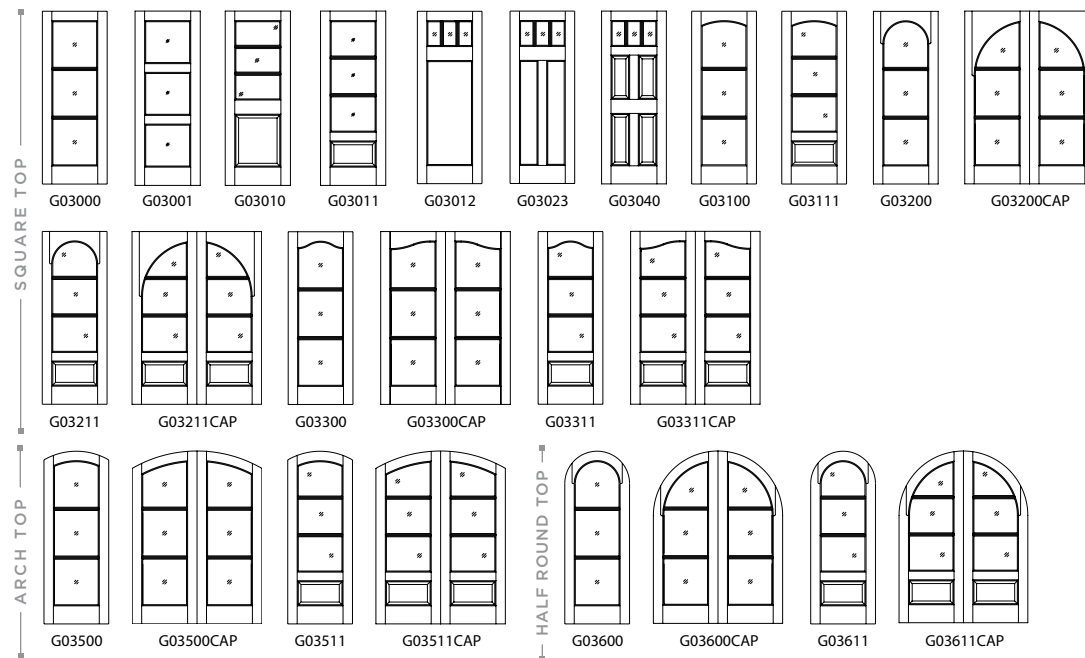

# REFERENCE GUIDE - LITED DOORS

## 4-LITE

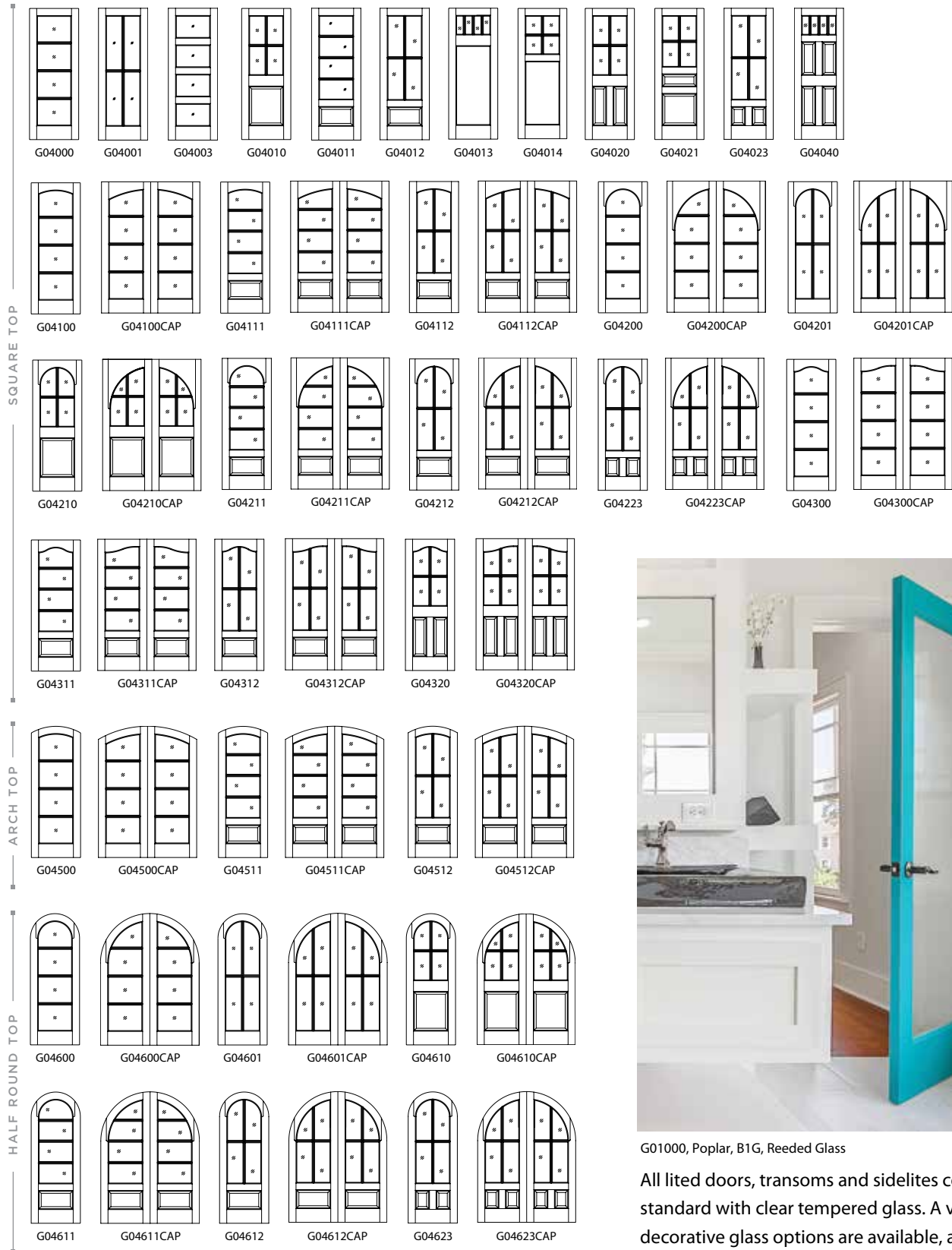

G01000, Poplar, B1G, Reeded Glass

All lited doors, transoms and sidelites come standard with clear tempered glass. A variety of decorative glass options are available, allowing you to create your own unique look. See pages 54-55 to view the entire glass collection.

# REFERENCE GUIDE - LITED DOORS

## 5-LITE

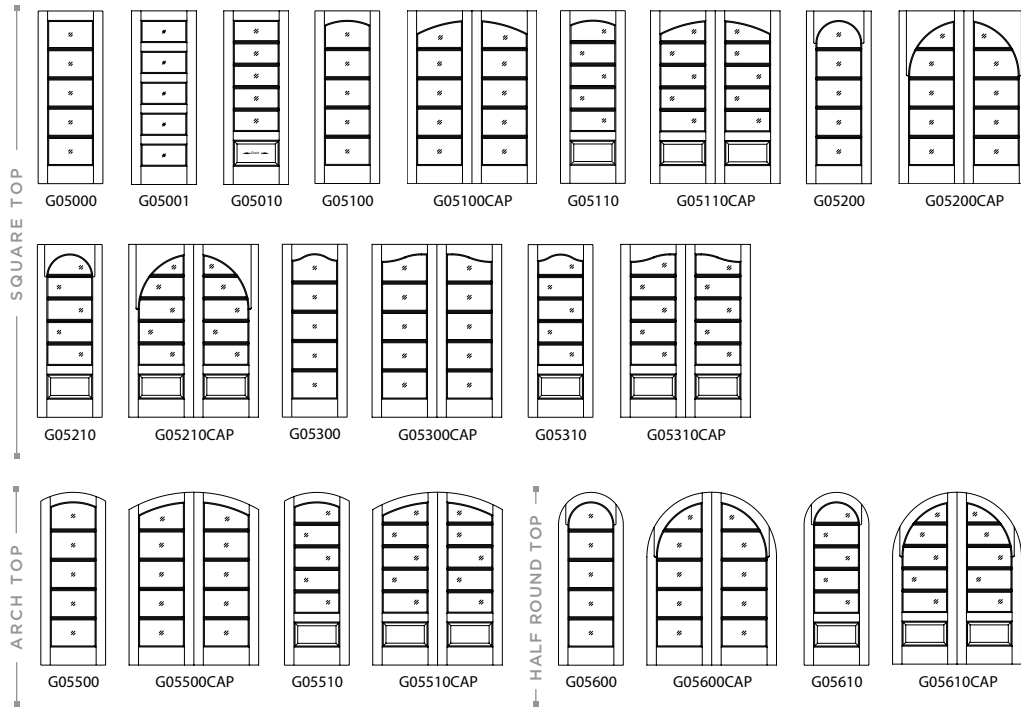

## 6-LITE

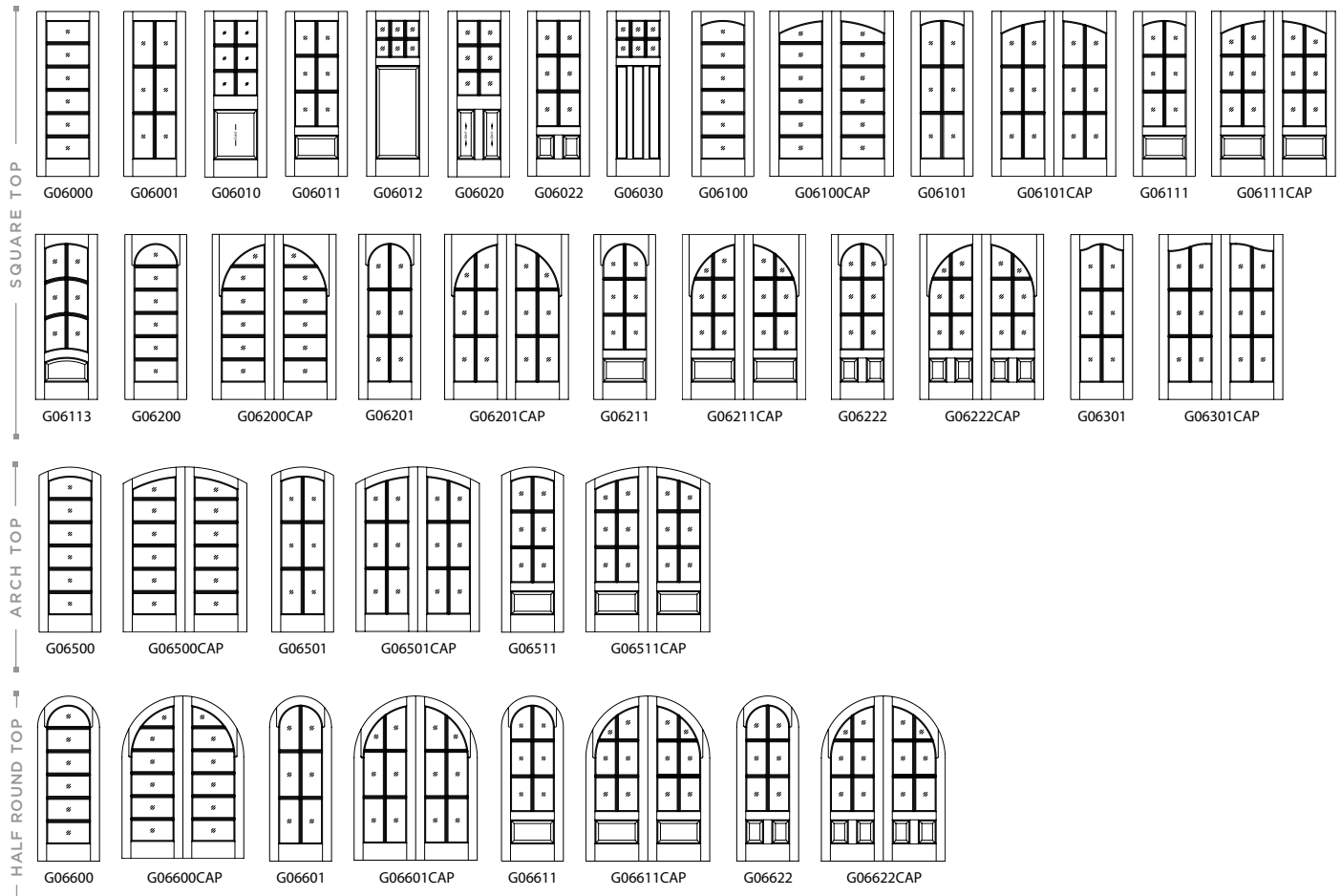

# REFERENCE GUIDE - LITED DOORS

## 8-LITE

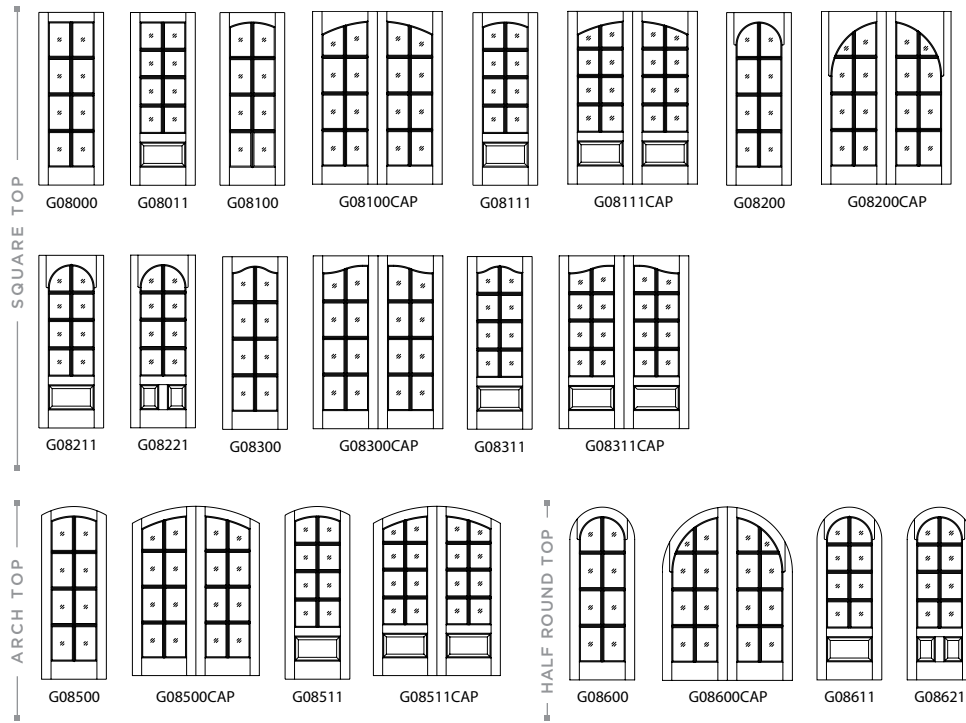

## 9-LITE

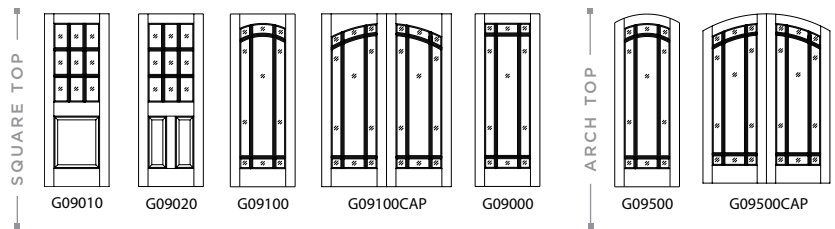

## 10-LITE

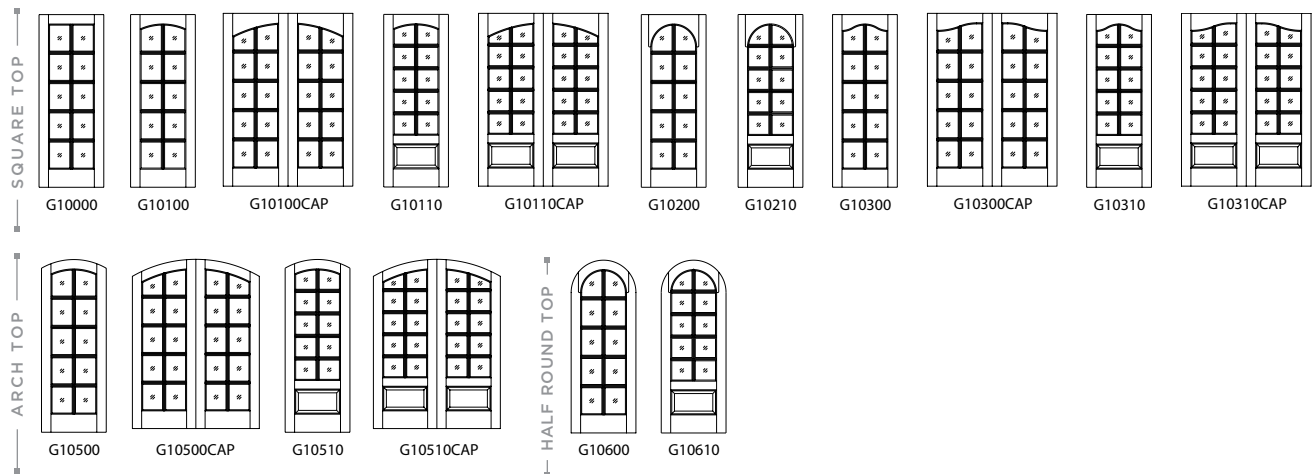



# REFERENCE GUIDE - LITED DOORS

## 12-LITE

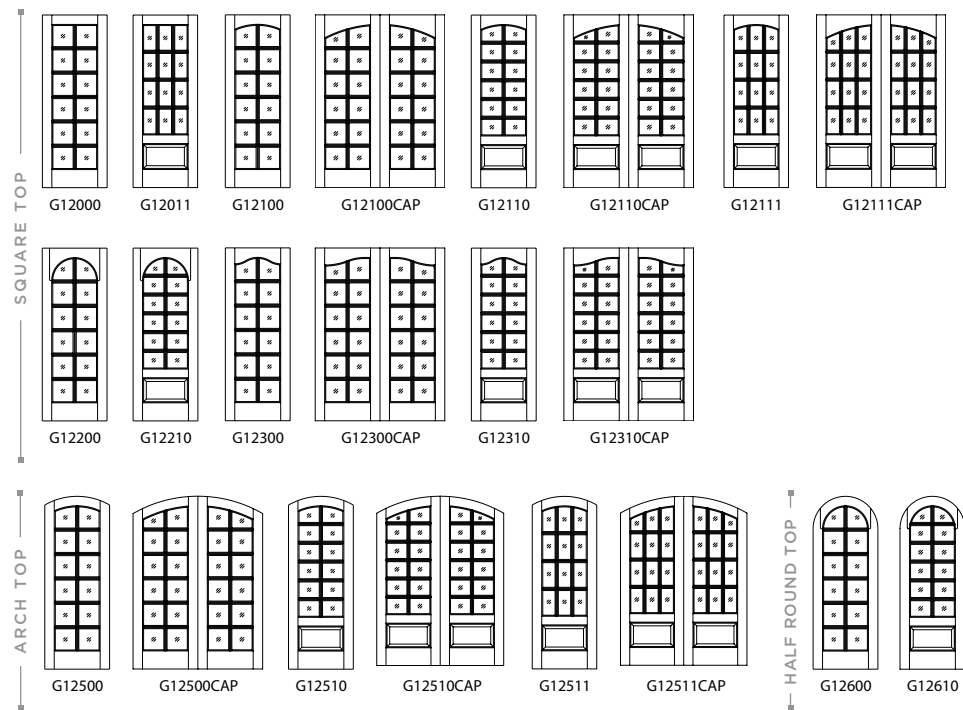

## 15-LITE



## 18-LITE

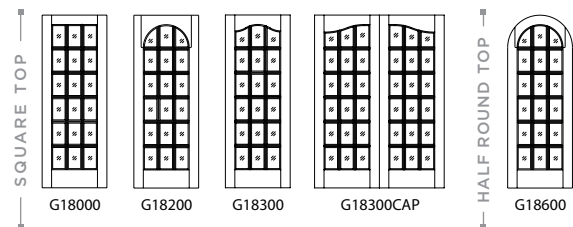

# TRANSOM SASHES

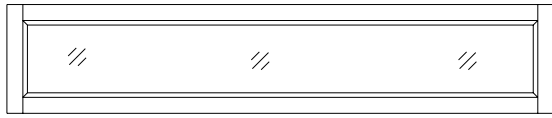

T01000

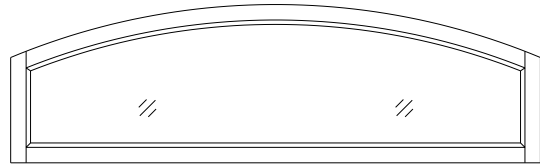

T01500

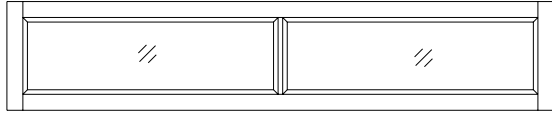

T02000

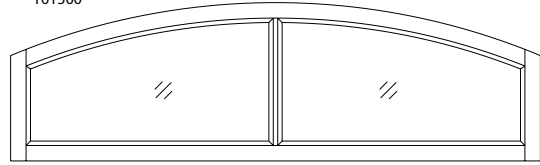

T02500

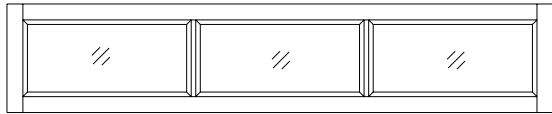

T03000

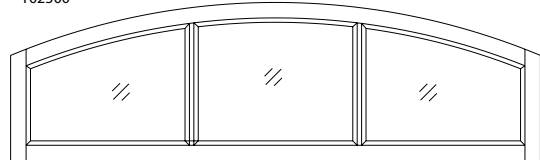

T03500

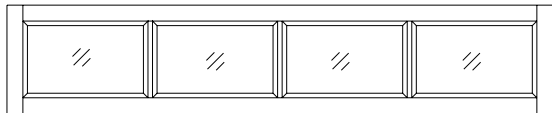

T04000

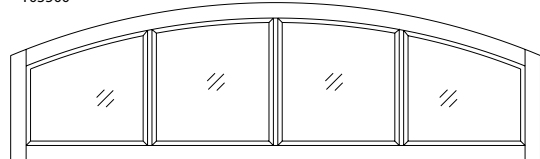

T04500

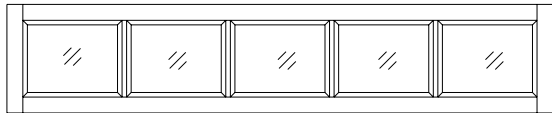

T05000

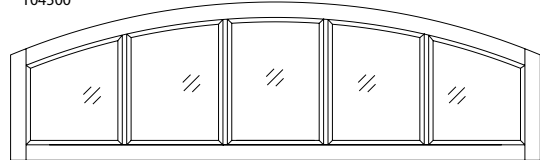

T05500

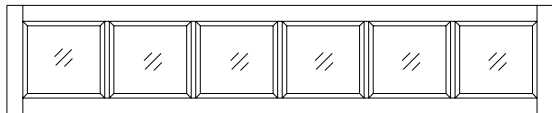

T06000

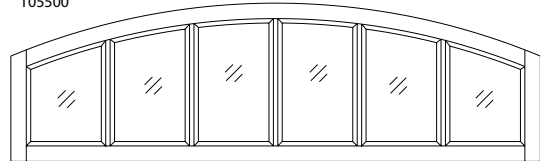

T06500

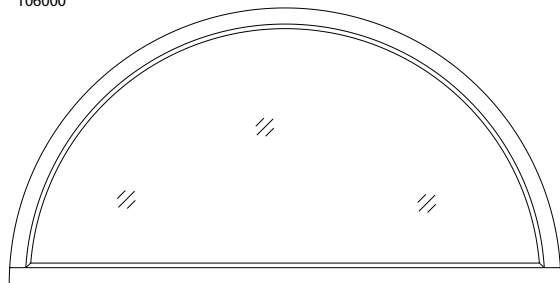

T01600

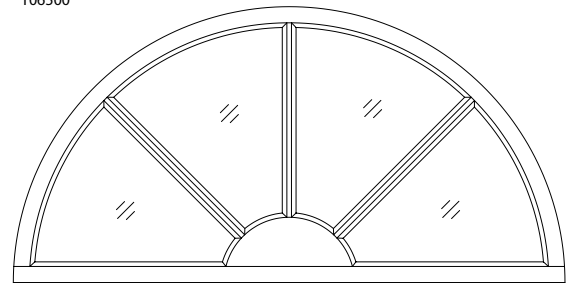

T04600

Drawings shown above feature Transom Sash construction. One lite transoms may also be ordered as Direct Set Transoms (shown bottom right). Please specify when ordering.

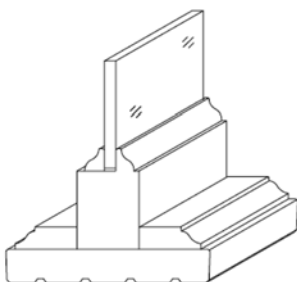

### Transom Sash

Constructed using the same methods as our standard stile and rail, true divided lite doors.

The standard face rail width on a transom sash is 1 3/4".

When ordering a transom sash, please provide us with the dimension of the sash itself, not including the jamb.

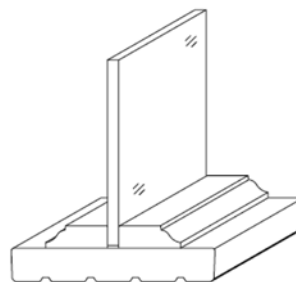

### Direct Set Transom

Direct Set Transoms are constructed by "double stopping" the glass directly on to the jamb. *This option is only available with one lite transom designs.*

When ordering direct set transoms, it is important to specify whether dimensions given are "inside to inside" or "outside to outside" of the frame.

# SIDELITES

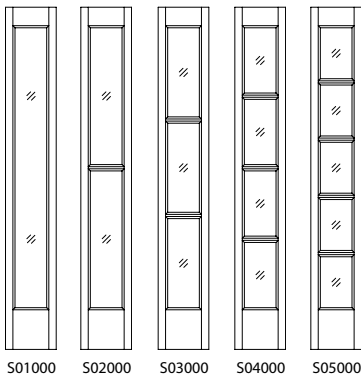

S01000 S02000 S03000 S04000 S05000

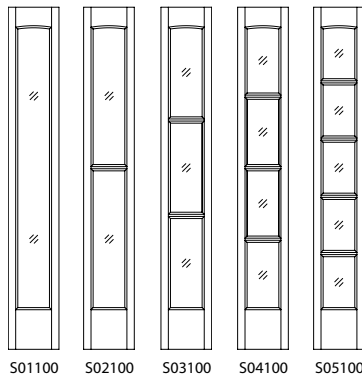

S01100 S02100 S03100 S04100 S05100

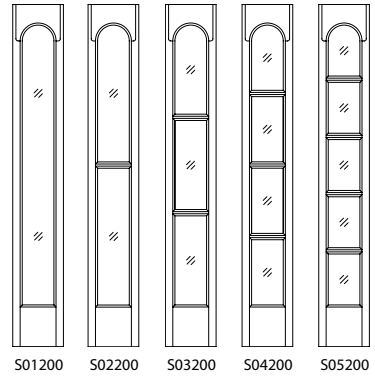

S01200 S02200 S03200 S04200 S05200

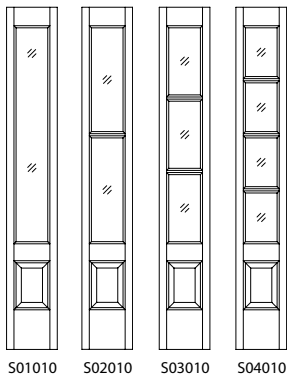

S01010 S02010 S03010 S04010

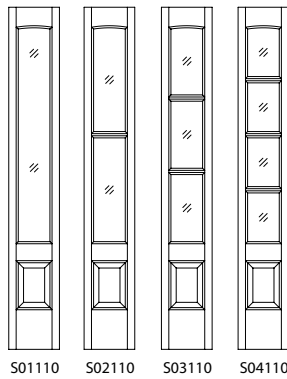

S01110 S02110 S03110 S04110

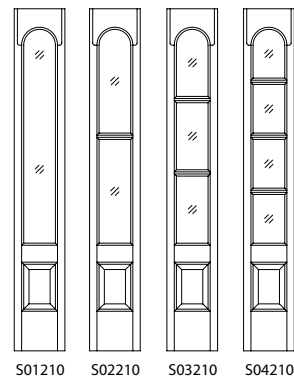

S01210 S02210 S03210 S04210

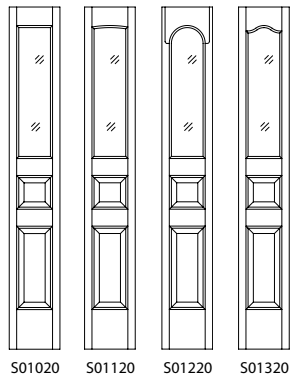

S01020 S01120 S01220 S01320

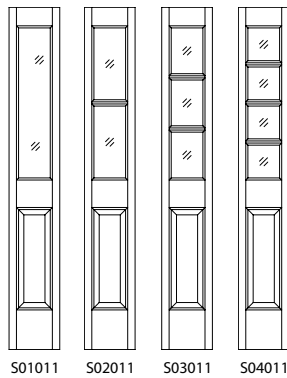

S01011 S02011 S03011 S04011

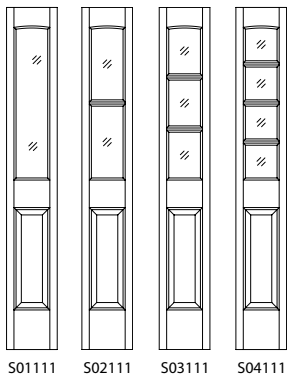

S01111 S02111 S03111 S04111

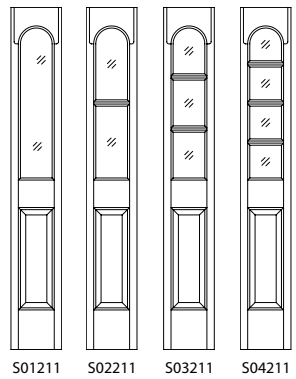

S01211 S02211 S03211 S04211



KW4000, E21-241, S01011 Sidelite, Aquatex glass, Poplar





# INTERIOR GLASS OPTIONS

## 1-3/8" RAIL WITH 1/4" TEMPERED GLASS

Images are shown at 31% of size.

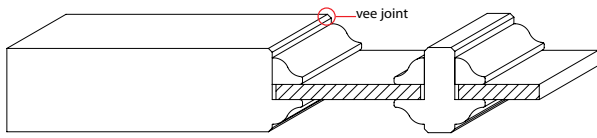

A1G

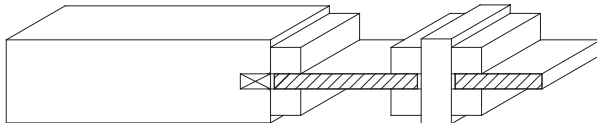

D1G

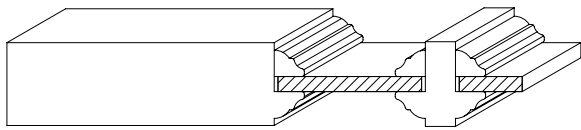

F1G

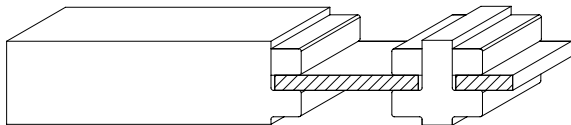

H1G

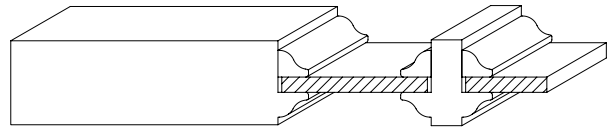

B1G

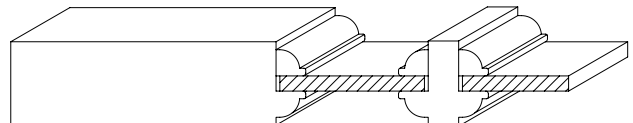

E1G

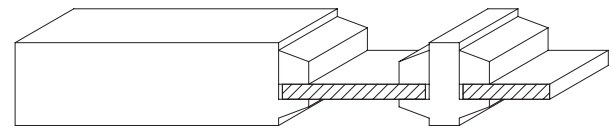

G1G

## 1-3/4" RAIL WITH 1/4" TEMPERED GLASS

Images are shown at 31% of size.

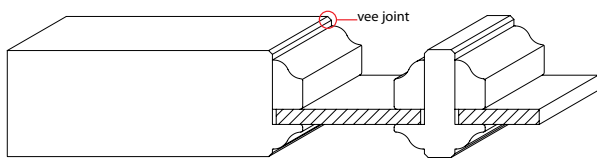

A2G

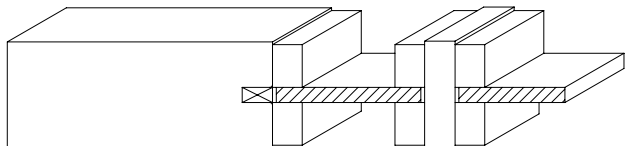

D2G

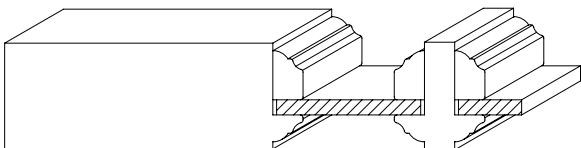

F2G

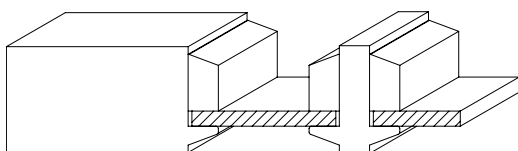

G2G

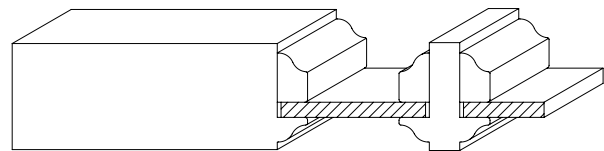

B2G

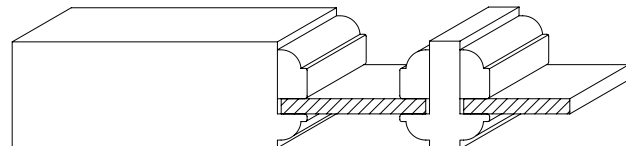

E2G

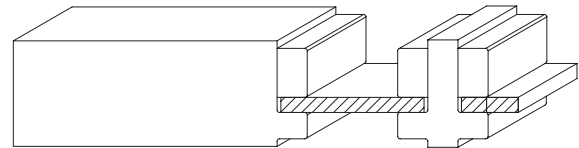

H2G

# INTERIOR GLASS OPTIONS

## 2-1/4" RAIL WITH 1/4" TEMPERED GLASS

Images are shown at 35% of size.

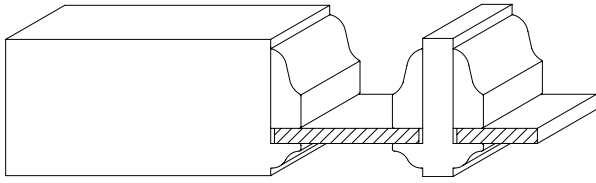

B5G

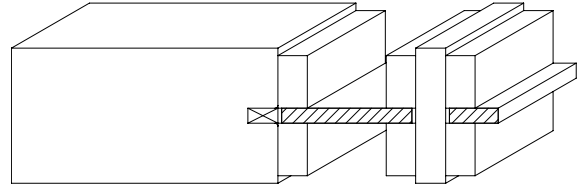

D5G

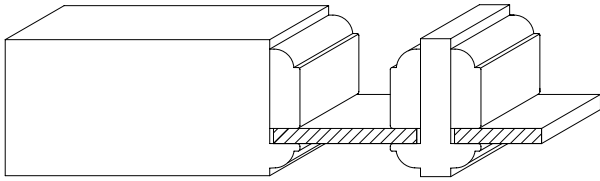

E5G

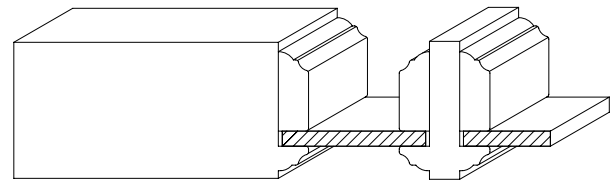

F5G

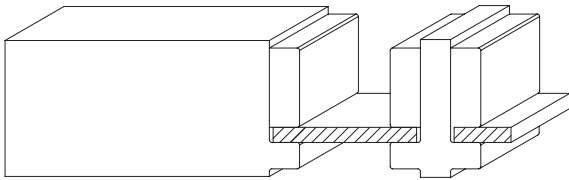

H5G

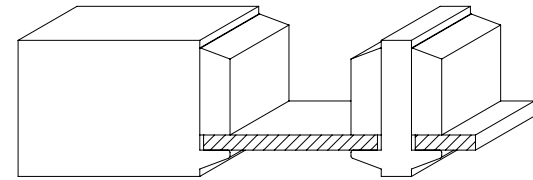

G5G



# EXTERIOR GLASS OPTIONS

## 1-3/4" RAIL WITH 5/8" TEMPERED GLASS

Images are shown at 31% of size.

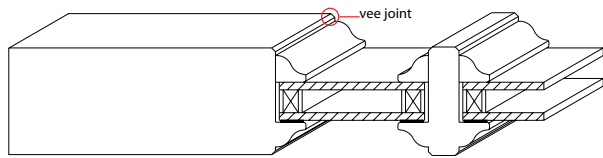

A2J

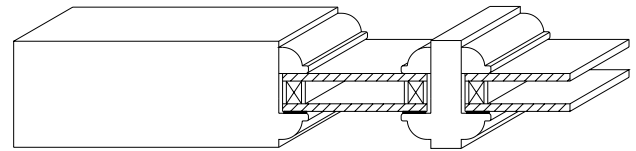

E2J

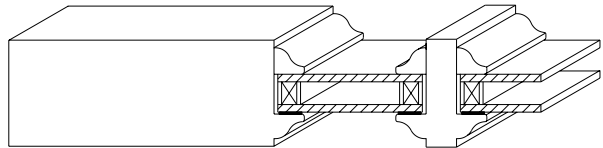

B2J

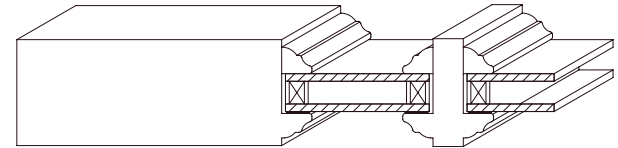

F2J

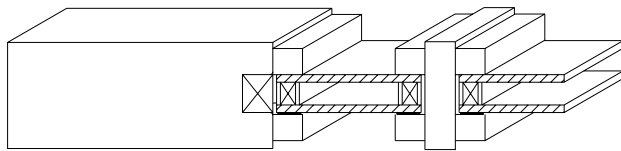

D2J

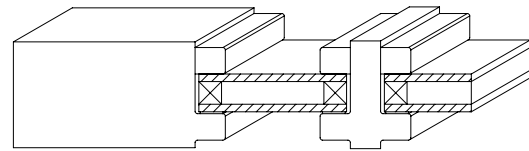

H2J

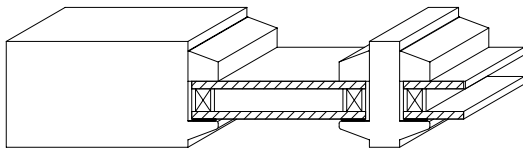

G2J (not available with door styles that contain panels)

## 2-1/4" RAIL WITH 3/4" TEMPERED GLASS

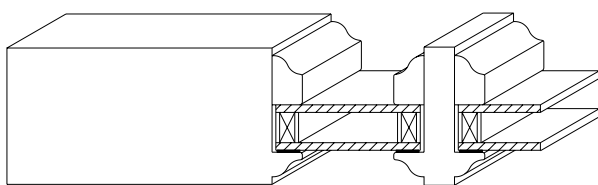

B5K

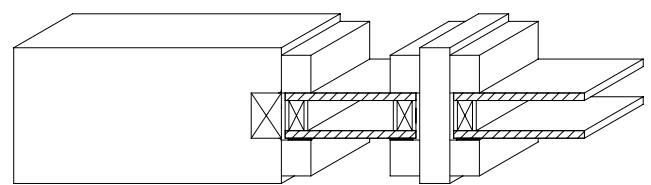

D5K

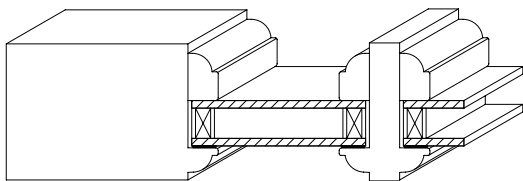

E5K

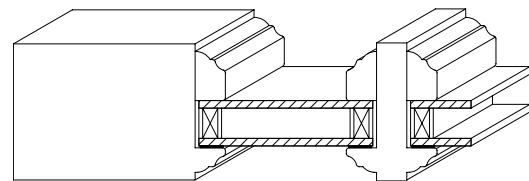

F5K

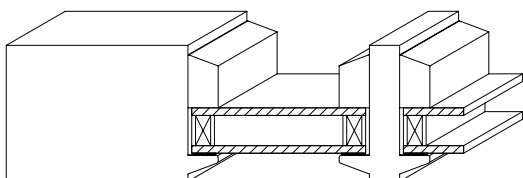

G5K

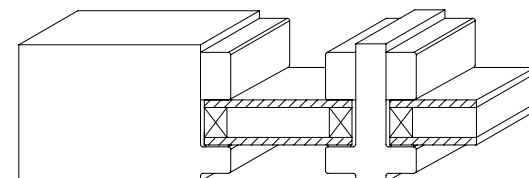

H5K





# CUSTOM GLASS OPTIONS

Interior Wood Products interior glass doors, transoms and sidelites come standard with clear tempered glass, or they may be ordered with any of these decorative glass options. All designs are available in insulated glass for exterior applications.



Aquatex



Autumn



Beveled



Bubbles



Cotswold

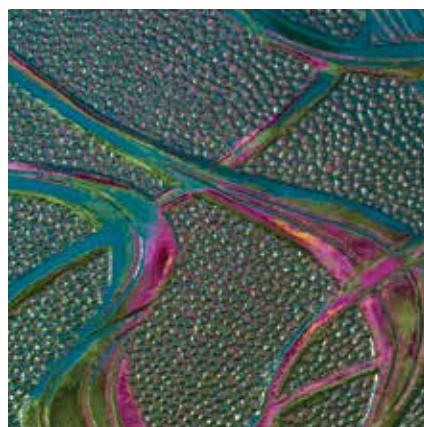

Everglade



Flemish



Glue Chip

# CUSTOM GLASS OPTIONS



Opal (*Frosted*)

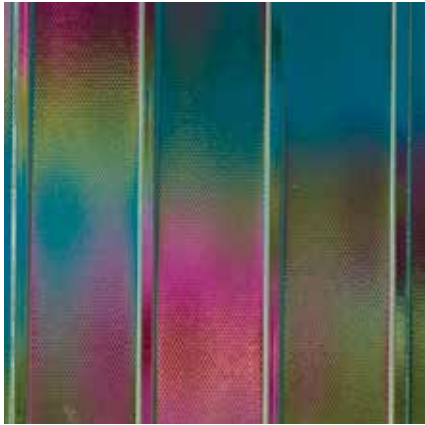

Master Linge



Pattern 62

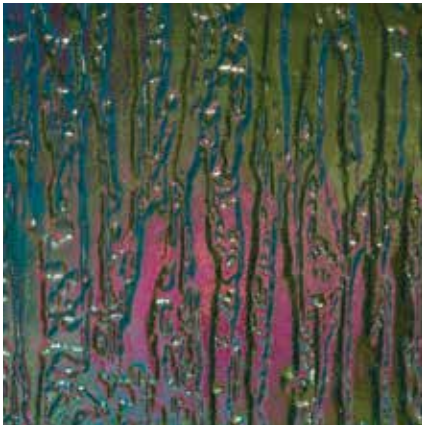

Rain

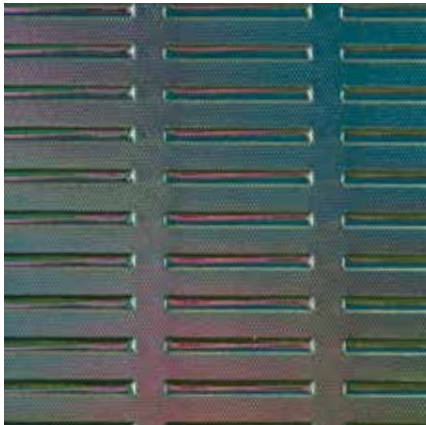

Master Ray



Reeded



Warick

# HARDWARE

## RESIDENTIAL HINGES 5/8" RADIUS CORNER



Antique Brass Finish



Antique Nickel Finish



Oil Rubbed Bronze Finish



Primed Finish



Flat Black



Satin Nickel Finish



Satin Brass Finish



Satin Chrome Finish



Bright Brass Finish



Bright Chrome Finish

Any hinge finish shown in our radius corner, residential offering (above) may be specified at no additional up-charge. In addition, we offer a wide selection of square corner, ball bearing and/or architectural hinges for an additional charge.

Please reference the Door & Jamb price book for all available options, along with pricing.

- = Square Corner Options Available
- = Radius Corner Ball Bearing Options Available
- ◆ = Square Corner Ball Bearing Options Available
- ▲ = Architectural Grade Options Available

Finish colors shown may vary due to the translation and reproduction limitations of photography.



## STANDARD FLUSH BOLTS FOR 6'8" - 7'0" TALL DOORS



**Satin Nickel** HDW FB-US15  
**Antique Nickel** HDW FB-US15A  
**Oil Rubbed Bronze** HDW FB-US10B  
 (used with flat black hinges)  
**Bright Chrome** HDW FB-US26  
**Bright Brass** HDW FB-US3  
**Antique Brass** HDW FB-US5  
**Satin Chrome** HDW FB-US26D

## EXTENDED FLUSH BOLTS INCLUDES EXTENDED ROD FOR DOORS TALLER THAN 7'0" (SHOWN)



**Satin Chrome** HDW ELFB-US26D  
**Flat Black** HDW ELFB-US19  
 (used with oil rubbed bronze hinges)  
**Satin Nickel** HDW ELFB-US15  
**Bright Brass** HDW ELFB-US3

## MAGNETIC CATCH



**HDW MAG CATCH**  
 Concealed Magnetic Door Catch  
 Stainless Steel Finish

## BALL CATCHES STANDARD BRIGHT BRASS ROLLER BALL SUPPLIED WITH EACH AS SHOWN



**Bright Brass** HDW BC-US3  
**Bright Chrome** HDW BC-US26  
**Antique Nickel** HDW BC-US15A  
**Oil Rubbed Bronze** HDW BC-US10B  
**Satin Nickel** HDW BC-US15  
**Satin Chrome** HDW BC-US26D  
**Antique Brass** HDW BC-US5

Finish colors shown may vary due to the translation and reproduction limitations of photography.



# HARDWARE

## SILLS, EXTENDERS & WEATHERSTRIP



Bronze/Oak Adjustable Sill - In Swing

BRO A28036 - 5-5/8" w x 36" l  
BRO A28073 - 5-5/8" w x 73" l

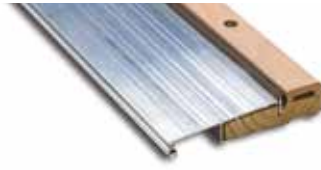

Aluminum/Oak Adjustable Sill - In Swing

ALU A28036 - 5-5/8" w x 36" l  
ALU A28073 - 5-5/8" w x 73" l



Bronze/Oak Adjustable Sill - Out Swing

BRO A11436 - 5-5/8" w x 36" l  
BRO A11473 - 5-5/8" w x 73" l

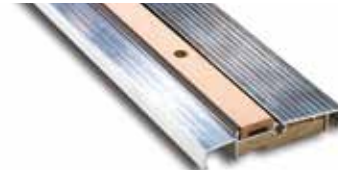

Aluminum/Oak Adjustable Sill - Out Swing

ALU A11436 - 5-5/8" w x 36" l  
ALU A11473 - 5-5/8" w x 73" l

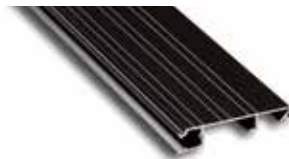

Bronze Sill Extension - 3"

BRO A112E36 - 3" w x 36" l  
BRO A112E73 - 3" w x 73" l



Aluminum Sill Extension - 3"

ALU A112E36 - 3" w x 36" l  
ALU A112E73 - 3" w x 73" l



Bronze Sill Extension - 2"

BRO A112C36 - 2" w x 36" l  
BRO A112C73 - 2" w x 73" l

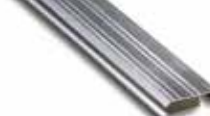

Aluminum Sill Extension - 2"

ALU A112C36 - 36" length  
ALU A112C73 - 73" length



Bronze ADA Compliant Sill

BRO ADA36 - 36" length  
BRO ADA74 - 74" length



Aluminum ADA Compliant Sill

ALU ADA36 - 36" length  
ALU ADA74 - 74" length



Door Sweep for 2 1/4" Doors - Chocolate

CHO 48-DS214 - 48" length



Door Sweep for 1 3/4" Doors - Chocolate

CHO 36-DS - 36" length  
CHO 48-DS - 48" length



Foam Weatherstrip - White

WHI 96-WS - 96" length



Foam Weatherstrip - Chocolate

CHO 36-WS - 36" length  
CHO 81-WS - 81" length  
CHO 96-WS - 96" length  
CHO RL-WS - Random Length

Finish colors shown may vary due to the translation and reproduction limitations of photography.

## POCKET DOORS

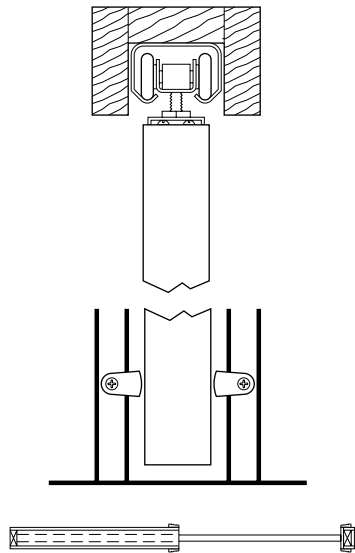

## BY-PASS DOORS

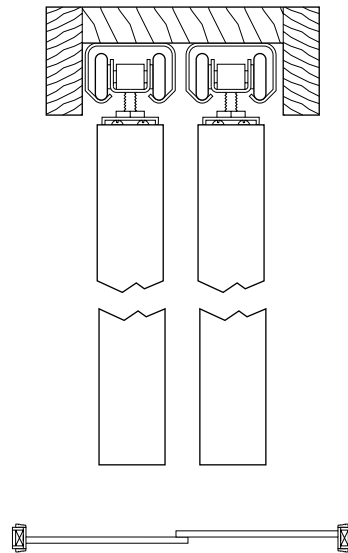

## BI-FOLD DOORS

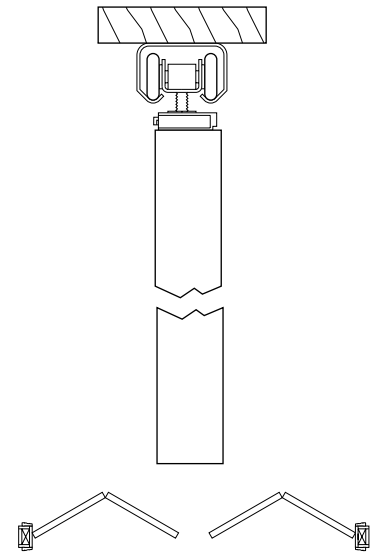

ITEM NUMBER	SIZE	DOOR THICKNESS
<b>Pocket</b> HDW 3068 Pocket HDW 3080 Pocket	2' to 3' wide up to 6' 8" high 2' to 3' wide up to 8' 0" high	1-3/8" to 1-3/4" 1-3/8" to 1-3/4"
<b>By-Pass</b> HDW 5 By-Pass HDW 6 By-Pass HDW 8 By-Pass	5' / two 2' 6" 6' / two 3' 0" 8' / two 4' 0"	1-3/8" to 1-3/4" 1-3/8" to 1-3/4" 1-3/8" to 1-3/4"
<b>Bi-Fold</b> HDW 3 Bi-Fold HDW 4 Bi-Fold HDW 5 Bi-Fold HDW 6 Bi-Fold HDW 8 Bi-Fold	2 door - 3' opening 4 door - 4' opening 4 door - 5' opening 4 door - 6' opening 4 door - 8' opening	1-1/8" to 1-3/4" 1-1/8" to 1-3/4" 1-1/8" to 1-3/4" 1-1/8" to 1-3/4" 1-1/8" to 1-3/4"

## DOOR SWINGS

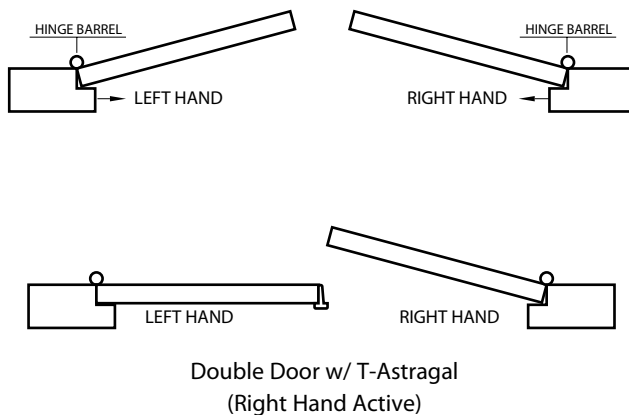

### STANDARD BORE

2-1/8" Bore with 2-3/8" Backset  
1" Plunger Hole

Standard bore location 35 15/16" from bottom of door.  
Certain optional bores available upon request.

### ABBREVIATIONS

S.B. - Standard Bore  
N.B. - No Bore  
R.H. - Right Hand  
L.H. - Left Hand  
DBL - Double Hung

# JAMBS & ACCESSORIES

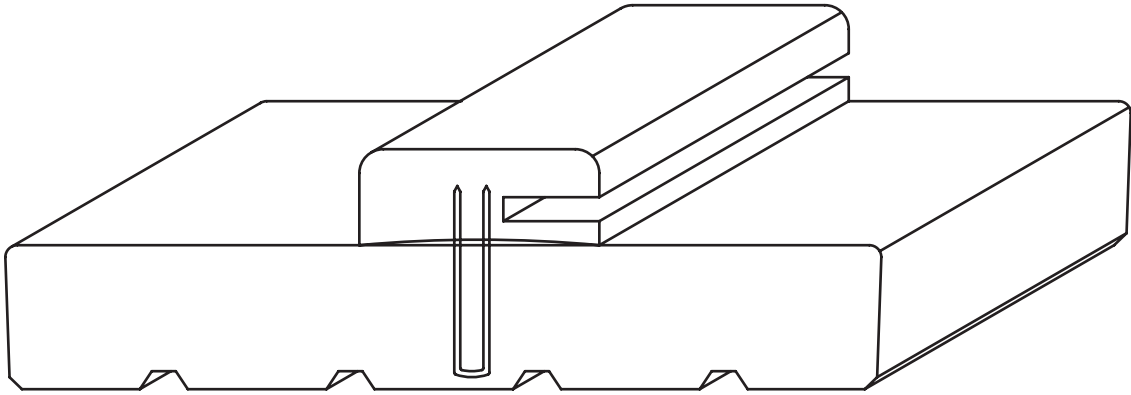

Applied Stop Jamb  
Kerfed for weatherstrip

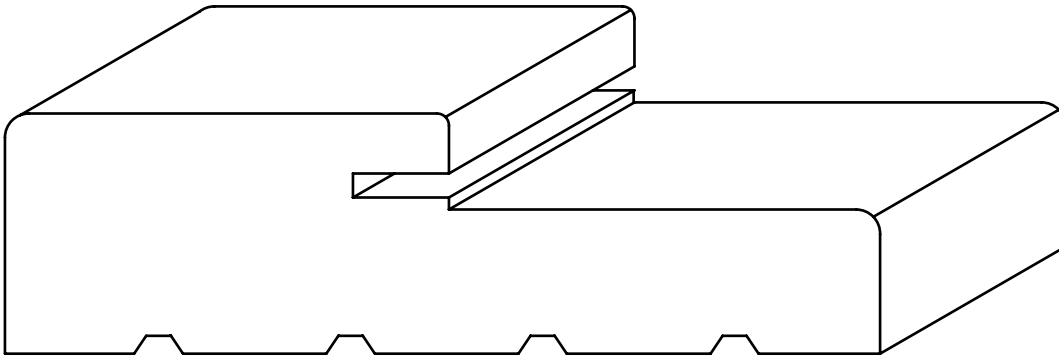

Single Rabbeted Exterior Jamb  
Kerfed for weatherstrip

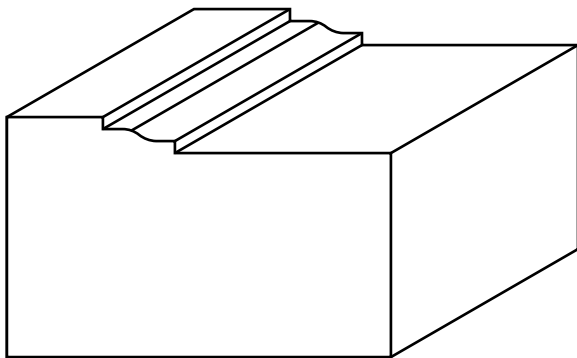

4064-BR 1 1/4" x 2"  
Brick Mould

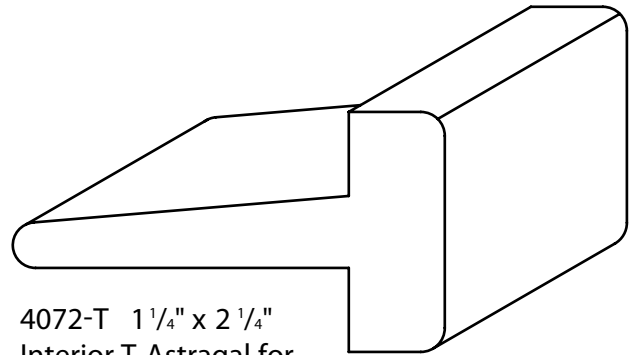

4072-T 1 1/4" x 2 1/4"  
Interior T-Astragal for  
1 3/8" or 1 3/4" door

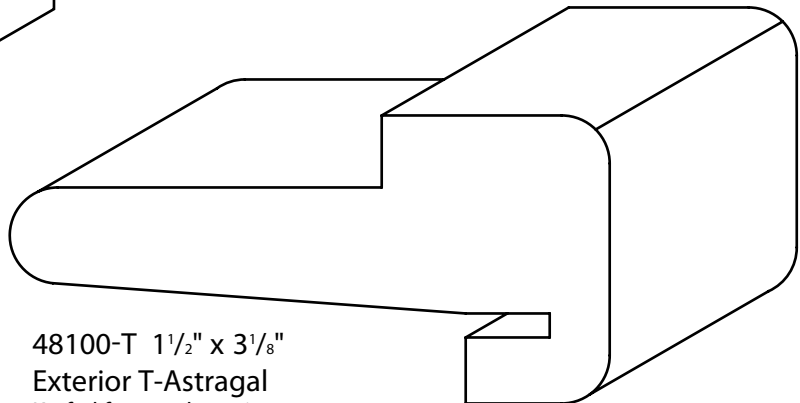

48100-T 1 1/2" x 3 1/8"  
Exterior T-Astragal  
Kerfed for weatherstrip

# JAMBS & ACCESSORIES

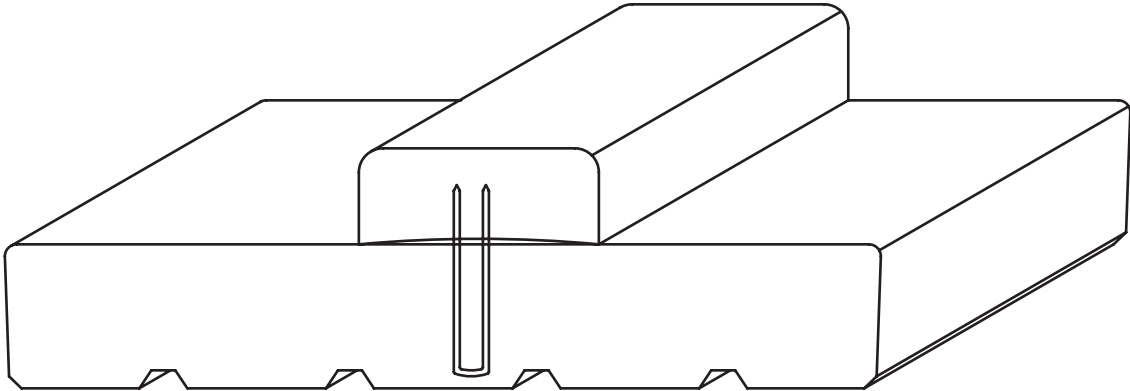

Applied Stop Jamb

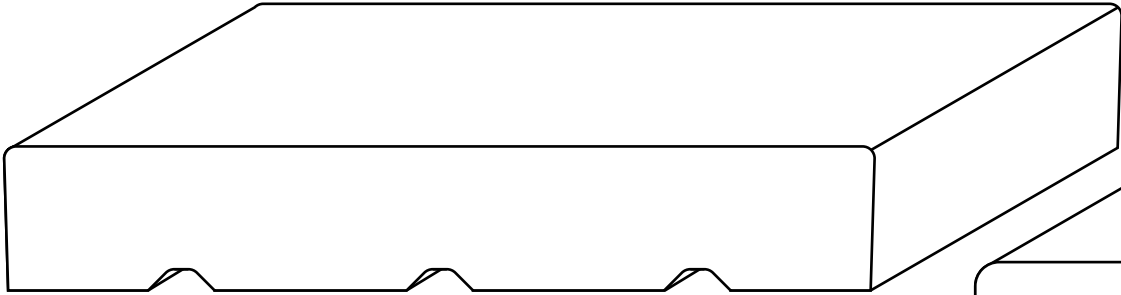

Flat Jamb

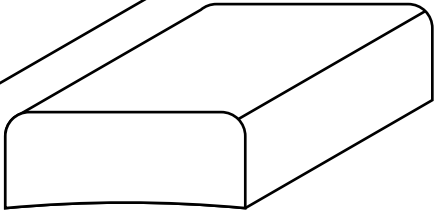

1640-Stop  $\frac{1}{2}$ " x  $1\frac{1}{4}$ "

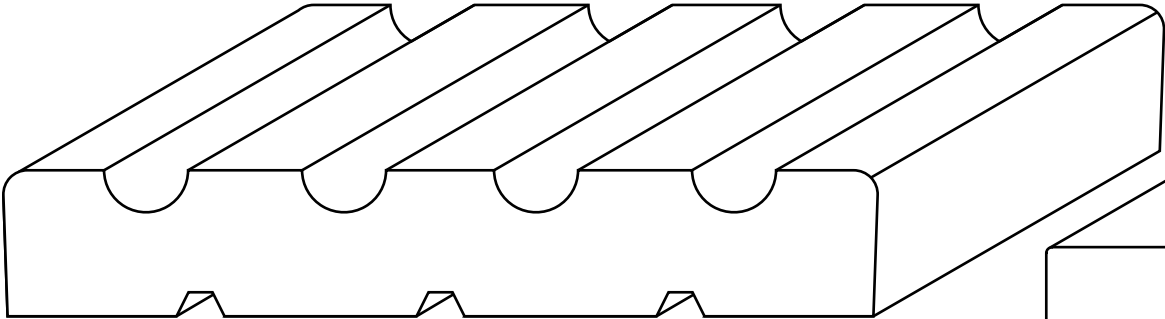

Fluted Jamb

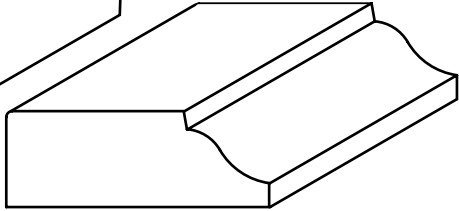

1644-KW-Stop  $\frac{1}{2}$ " x  $1\frac{3}{8}$ "

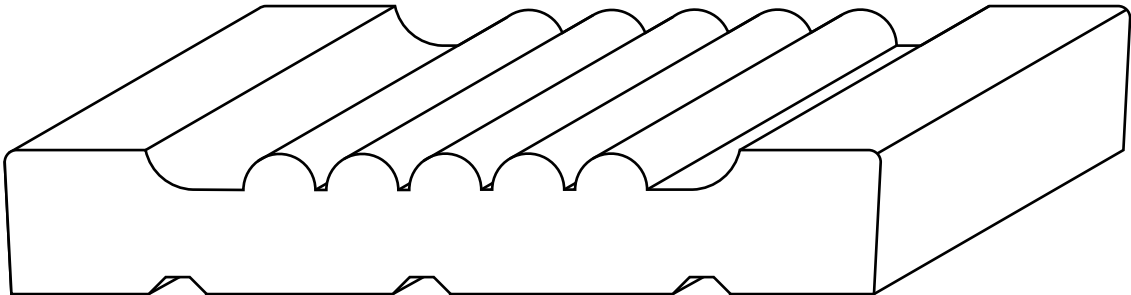

Reeded Jamb



# AVAILABLE SPECIES & CONSTRUCTION FEATURES

Our furniture quality doors are hand-crafted from some of the finest woods available. Additional species are available upon request.



**Alder**  
(stiles may be edge glued)



**Knotty Alder**  
(stiles may be edge glued)



**Cherry**



**Vertical Grain Fir**



**Hickory**  
(limited availability based on door style/size)



**KW Mahogany**



**Hard Maple**



**Red Oak**



**Red Oak**  
(rift and quartered)



**White Oak**



**White Oak**  
(rift and quartered)



**Walnut**  
(stiles may be edge glued)



**White Pine**



**Knotty White Pine**



**Cypress**



**Poplar**

*Photography does not represent all of the natural variation in grain and color that will occur in the production of a complete door package.*

## QUALITY CONSTRUCTION FEATURES

Profiles are precision machined with diamond and carbide tooling, resulting in well-defined detailing.

Solid wood panel construction provides crisp, detailed edges unlike veneer wrapped panels.

5/8" x 4" solid wood dowel is used at every stile and rail joint providing added strength and stability.

Free floating panels with flexible rubber spacers allow the panels to stay centered during normal expansion and contraction.

Doors feature solid, hardwood stave core stiles\* with a substantial 1/8" lumber face, solid wood rails and panels, providing exceptional strength and stability.

\* All knotty species as well as fire rated doors are manufactured with face laminated stiles.

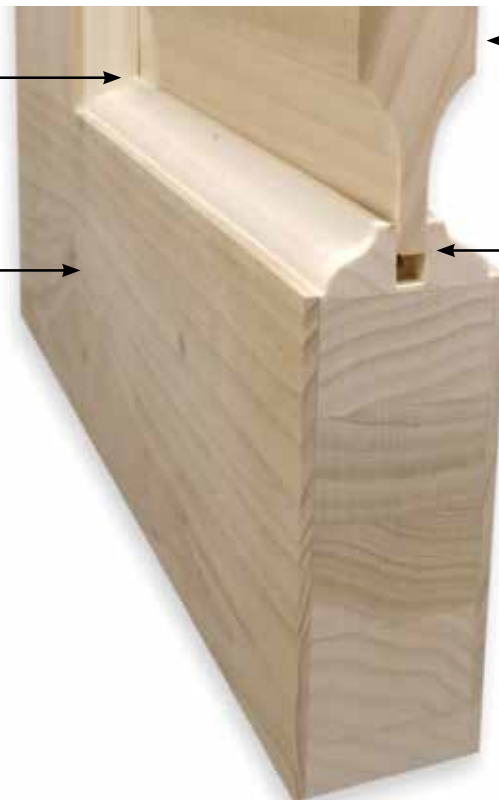





DOORS - MOULDINGS - STAIR PARTS  
HARDWARE

Interior Wood Products  
(614)504-5486  
[www.IWPOHIO.com](http://www.IWPOHIO.com)