



— Manufacturing and Distribution of —  
**Architectural Millwork & Select Building Products**

## STAIR PARTS





For over half a century, we have provided products and solutions for the residential and commercial building industry as well as fine furniture and cabinet manufacturers.

In addition to the products we manufacture, we proudly partner with a variety of supply chains, allowing us to be your one-stop source for mouldings, doors, stair components, specialty millwork and more.

Available Species..... 2

Rail, Shoe & Fillet..... 3

**NEWELS**

Box Newels ..... 5

Post To Post Newels ..... 6-7

Over The Post Newels..... 9

**BALUSTERS**

Lite Iron Balusters..... 10-15

Wood Balusters ..... 16-17

Fittings ..... 18-19

Treads, Risers & Accessories ..... 20-21

Starting Steps ..... 22

Hardware..... 23

In addition to Stair Parts, Interior Wood Products supplies a full line of Architectural Millwork Stile & Rail Wood Doors. Please visit [www.IWPOHIO.com](http://www.IWPOHIO.com) to view any of our complete catalogs.

# AVAILABLE SPECIES



Beech



Brazilian  
Cherry



Cherry



Hickory



Mahogany



Maple



Poplar



Primed



Red Oak



Soft Maple



Walnut



White Oak

*Additional Species Available Upon Request*

# RAIL, SHOE & FILLET

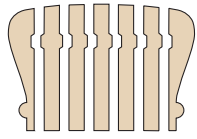
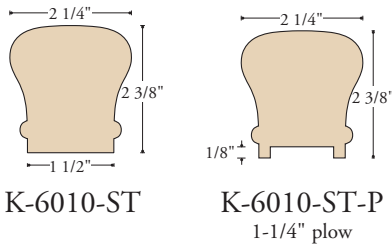

K-6010-B  
Includes bending mould

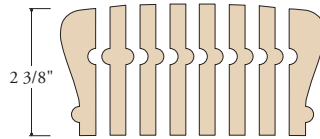
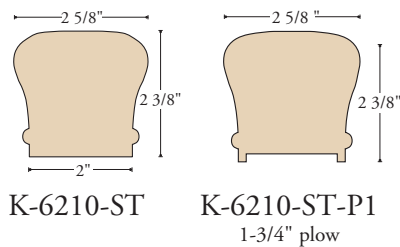

K-6210-B  
Includes bending mould

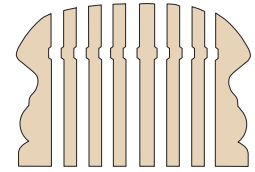
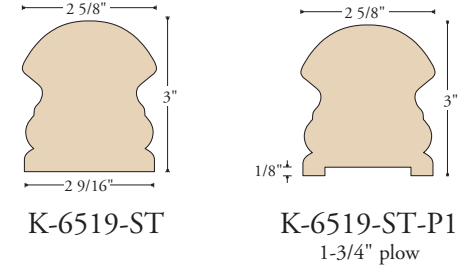

K-6519-B  
Includes bending mould

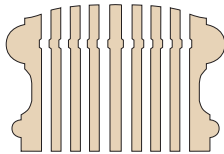
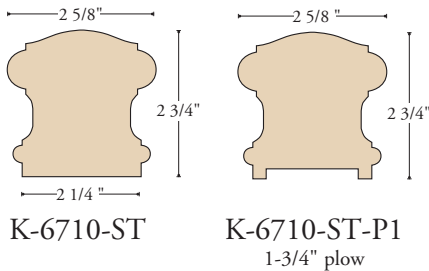

K-6710-B  
Includes bending mould

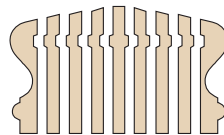
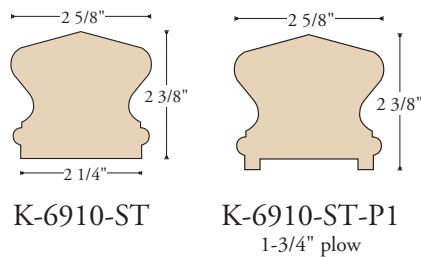

K-6910-B  
Includes bending mould

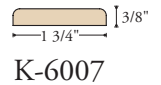
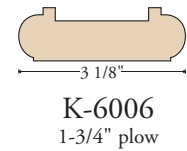
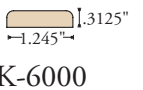
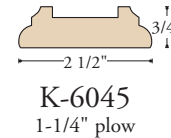

## ADDITIONAL RAIL PROFILES (BENDING RAIL & FITTINGS NOT AVAILABLE)

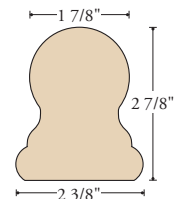
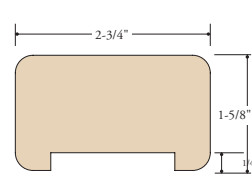
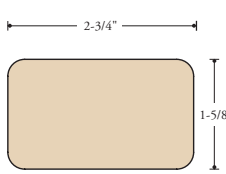
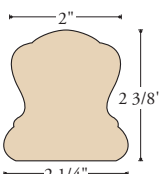
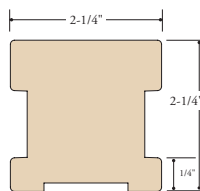
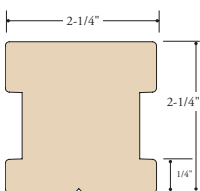
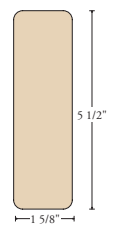
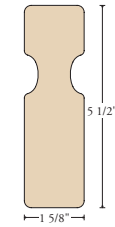
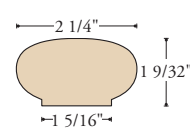
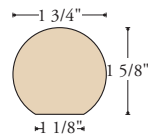
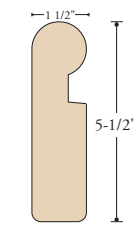
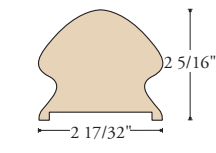
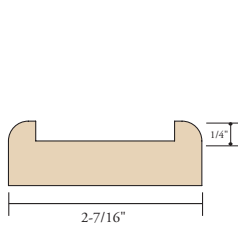

\* = These handrail profiles may not comply with your local building codes.



# BOX NEWELS

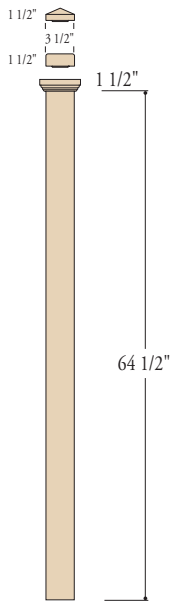

**K-4075\***  
3-1/2" X 64-1/2"

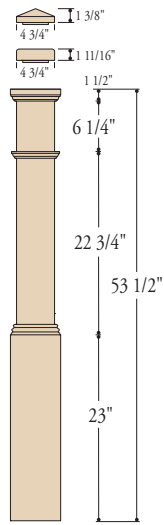

**K-4091\***  
6-1/4" X 53-1/2"

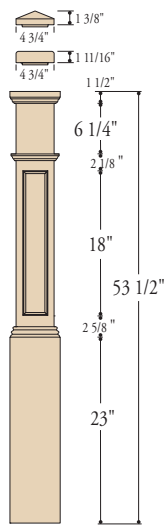

**K-4091-FP\***  
6-1/4" X 53-1/2"

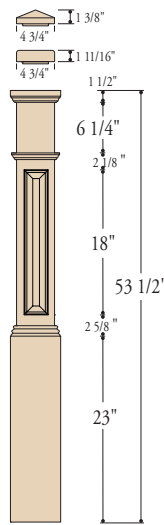

**K-4091-RP\***  
6-1/4" X 53-1/2"

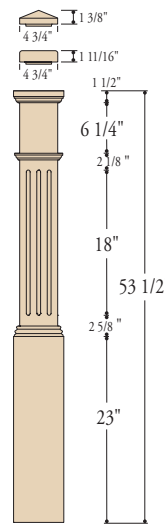

**K-4091-F\***  
6-1/4" X 53-1/2"

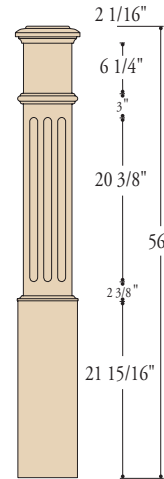

**K-4095-F**  
7-1/2" X 56"

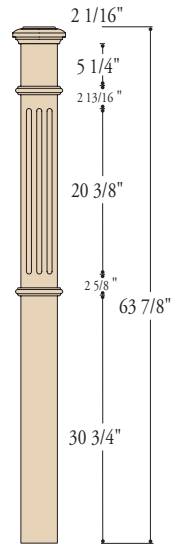

**K-4695-F**  
4-1/2" X 63-7/8"

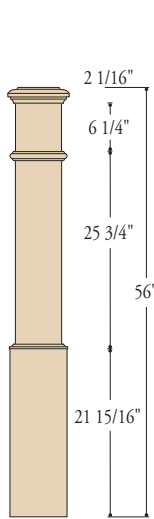

**K-4095**  
7-1/2" X 56"

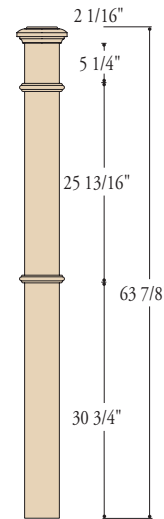

**K-4695**  
4-1/2" X 63-7/8"

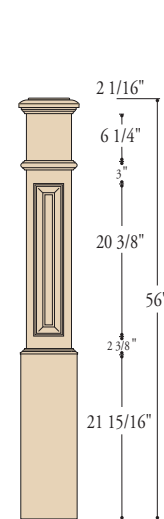

**K-4891-RP**  
7-1/2" X 56"

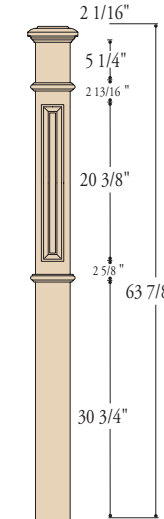

**K-4691-RP**  
4-1/2" X 63-7/8"

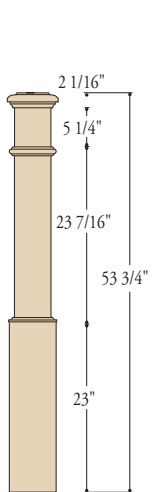

**K-4090**  
6-1/4" X 53-3/4"

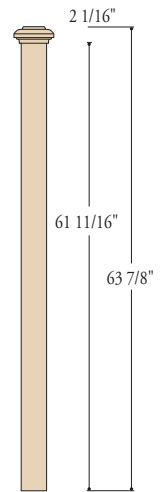

**K-4077**  
3-1/2" X 63-7/8"

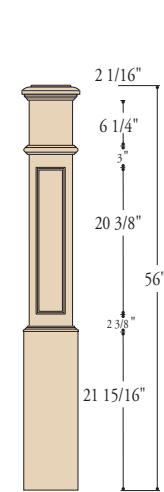

**K-4891-FP**  
7-1/2" X 56"

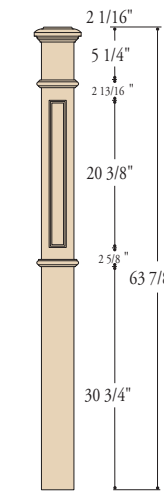

**K-4691-FP**  
4-1/2" X 63-7/8"

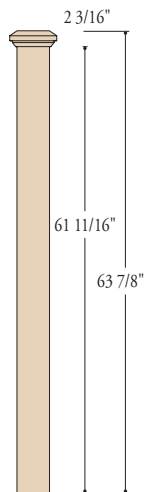

**K-4690**  
4-1/2" X 63-7/8"



\*These Box Newels are shipped with interchangeable flat and peak caps.

Mounting block and lag screws are included with all hollow box newels.

All box newels which are 4-1/2" and larger are hollow.

# POST TO POST NEWELS

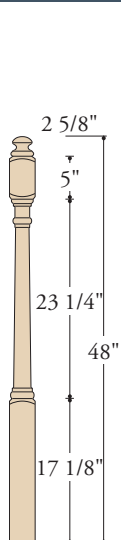

**K-4040**  
3" X 48"  
STARTING

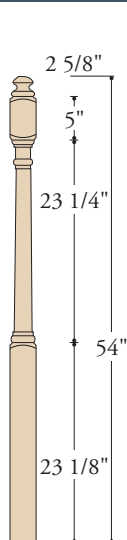

**K-4042**  
3" X 54"  
STARTING

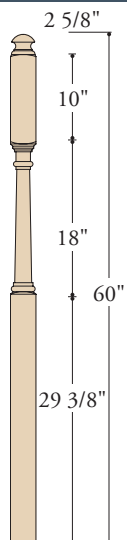

**K-4045**  
3" X 60"  
LANDING

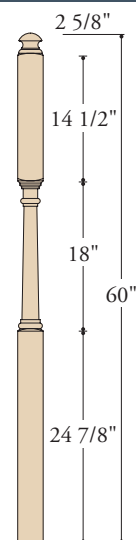

**K-4046**  
3" X 60"  
LANDING

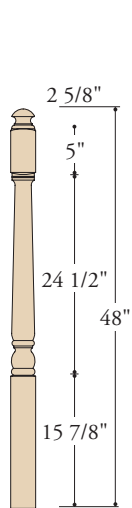

**K-4040-A**  
3" X 48"  
STARTING

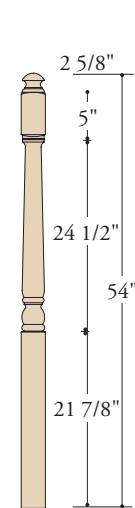

**K-4042-A**  
3" X 54" (F)  
STARTING

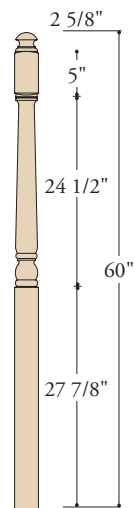

**K-4043-A**  
3" X 60" (F)  
STARTING

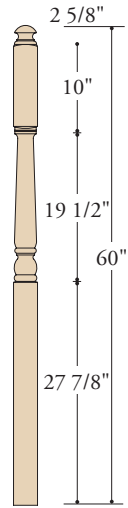

**K-4045-A**  
3" X 60" (F)  
LANDING

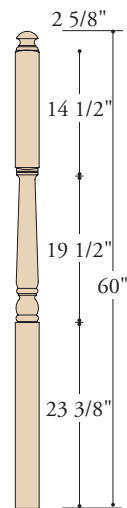

**K-4046-A**  
3" X 60" (F)  
LANDING



All "404X" newel posts featured on this page are available with a ball top. Specify BT when ordering.

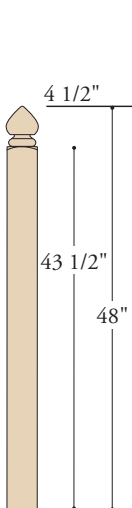

**K-4004**  
3-1/2" X 48"  
STARTING

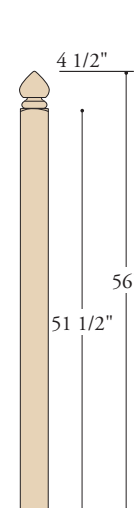

**K-4005**  
3-1/2" X 56"  
LANDING

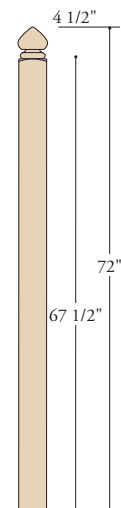

**K-4006**  
3-1/2" X 72"  
LANDING

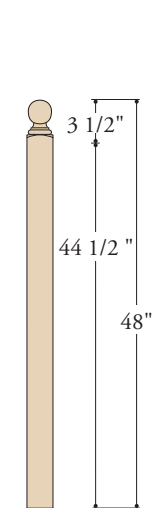

**K-4004-BT**  
3-1/2" X 48"  
STARTING

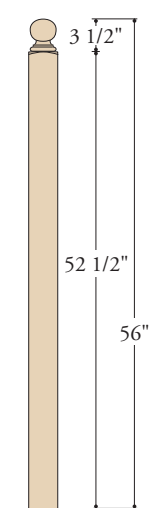

**K-4005-BT**  
3-1/2" X 56"  
LANDING



**Reeded (R)**



**Fluted (F)**



**Twisted (T)**



**Octagonal (O)**

Several balusters and newels are also available in Reeded, Twisted, Fluted, and Octagonal as designated with a **R** (Reeded), **T** (Twisted), **F** (Fluted), or **O** (Octagonal) below the corresponding part numbers. Call for pricing and lead times.



# POST TO POST NEWELS

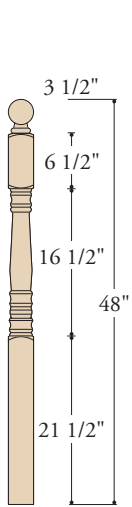

**K-4300**  
3" X 48"  
STARTING

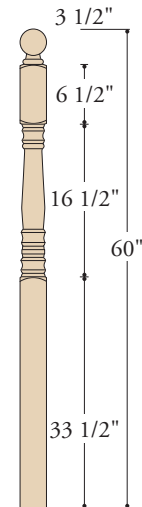

**K-4304**  
3" X 60"  
STARTING/LANDING

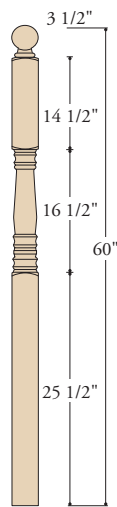

**K-4305**  
3" X 60"  
LANDING

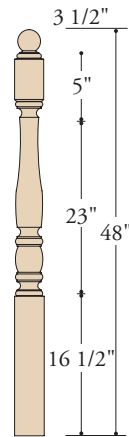

**K-5548**  
3-1/2" X 48"  
(F, R, O)  
STARTING

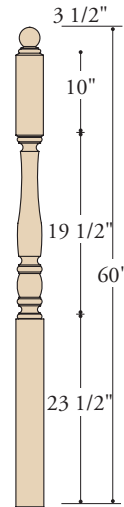

**K-5545**  
3-1/2" X 60"  
(F, R, O)  
LANDING

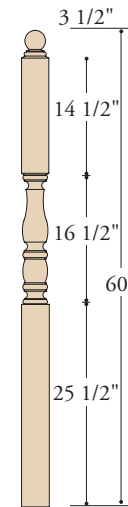

**K-5546**  
3-1/2" X 60"  
(F, R, O)  
LANDING

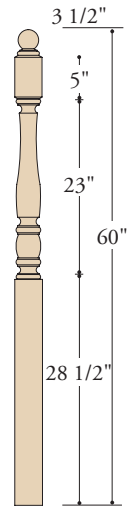

**K-5560**  
3-1/2" X 60"  
(F, R, O)  
STARTING/LANDING

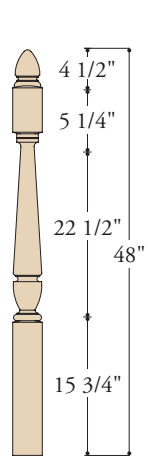

**K-3030-ST**  
3-1/2" X 48"  
(F, T, O)  
STARTING

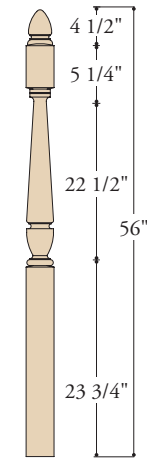

**K-3042-ST**  
3-1/2" X 56"  
(F, T, O)  
STARTING/LANDING

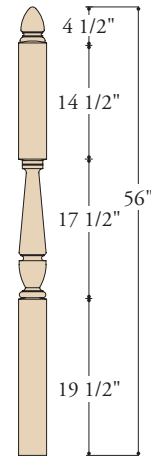

**K-3046-ST**  
3-1/2" X 56"  
(F, T, O)  
LANDING

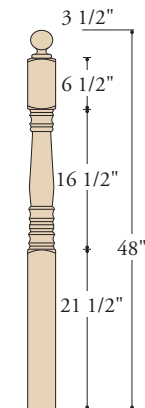

**K-4500**  
3-1/2" X 48" (O)  
STARTING

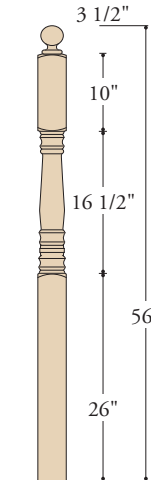

**K-4503**  
3-1/2" X 56" (O)  
LANDING

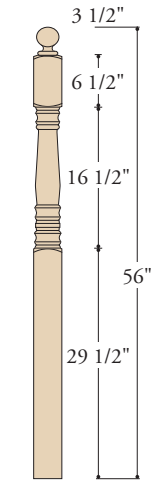

**K-4504**  
3-1/2" X 56" (O)  
STARTING/LANDING

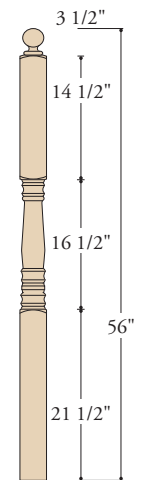

**K-4505**  
3-1/2" X 56" (O)  
STARTING

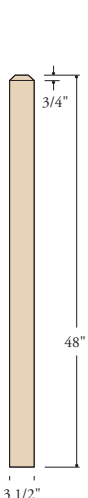

**K-4002-48**  
3-1/2" X 48"  
STARTING

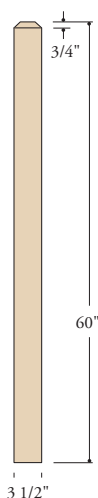

**K-4002-60**  
3-1/2" X 60"  
LANDING

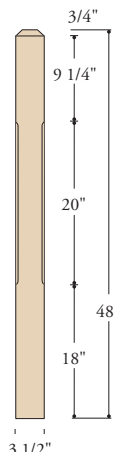

**K-4002-C-48**  
3-1/2" X 48"  
STARTING

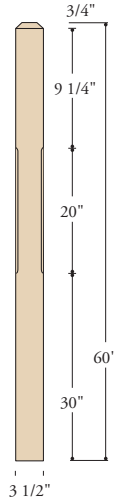

**K-4002-C-60**  
3-1/2" X 60"  
LANDING

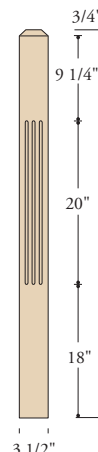

**K-4002-F-48**  
3-1/2" X 48"  
STARTING

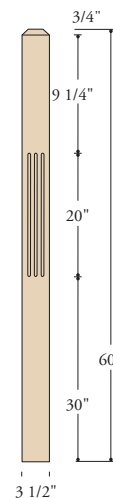

**K-4002-F-60**  
3-1/2" X 60"  
LANDING



**K-4003-S4S 48**  
3-1/2" X 48"  
S4S SQUARE

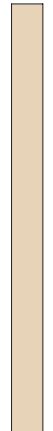

**K-4003-S4S 60**  
3-1/2" X 60"  
S4S SQUARE



# OVER THE POST NEWELS

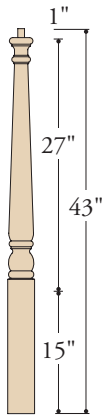

**K-4010**  
3" X 43" (F)  
STARTING  
(Square Base)

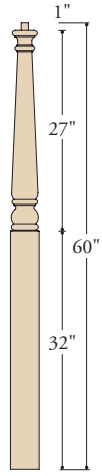

**K-4015**  
3" X 60" (F)  
LANDING  
(Square Base)

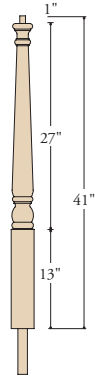

**K-4050-RB**  
3" X 41" (F)  
STARTING  
(Round base, loose dowel)

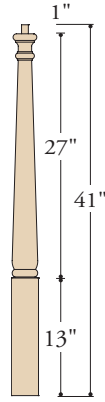

**K-4061-41**  
3" X 41"  
STARTING  
(Square Base)

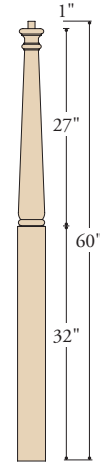

**K-4061-60**  
3" X 60"  
LANDING  
(Square Base)

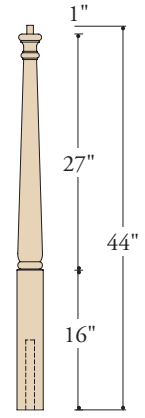

**K-4061-RB**  
2-3/4" X 44"  
STARTING  
(Round base, loose dowel)

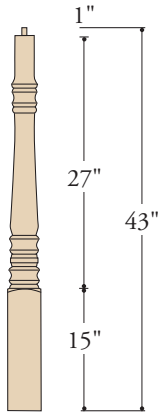

**K-4270**  
3-1/2" X 43" (O)  
STARTING  
(Square Base)

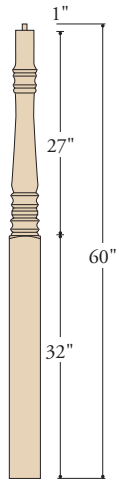

**K-4275**  
3-1/2" X 60" (O)  
LANDING  
(Square Base)

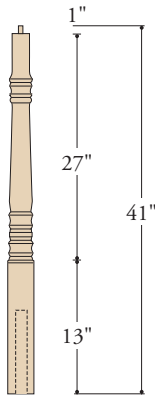

**K-4272-RB**  
3-1/2" X 41" (O)  
VOLUTE  
(Round base, loose dowel)

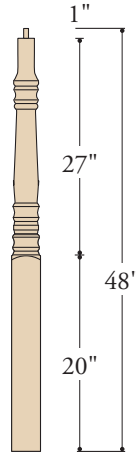

**K-4271**  
3-1/2" X 48" (O)  
STARTING  
(Square Base)

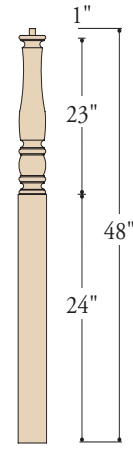

**K-5511**  
3-1/2" X 48" (F, R, O)  
STARTING  
(Square Base)

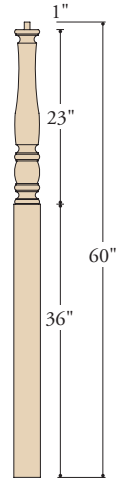

**K-5515**  
3-1/2" X 60" (F, R, O)  
LANDING  
(Square Base)

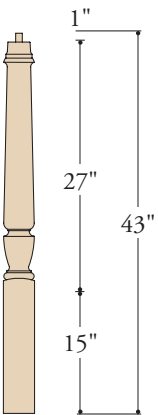

**K-3010**  
3-1/2" X 43" (F, T)  
STARTING  
(Square Base)

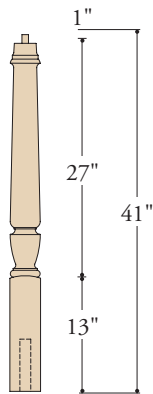

**K-3012**  
3-1/2" X 41" (F, T)  
STARTING  
(Square base, loose dowel)

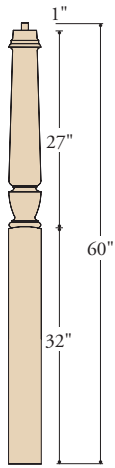

**K-3015**  
3-1/2" X 60" (F, T)  
LANDING  
(Square Base)



**Reeded (R)**



**Fluted (F)**



**Twisted (T)**



**Octagonal (O)**

Several balusters and newels are also available in Reeded, Twisted, Fluted, and Octagonal as designated with a **R** (Reeded), **T** (Twisted), **F** (Fluted), or **O** (Octagonal) below the corresponding part numbers. Call for pricing and lead times.

# LITE IRON BALUSTERS

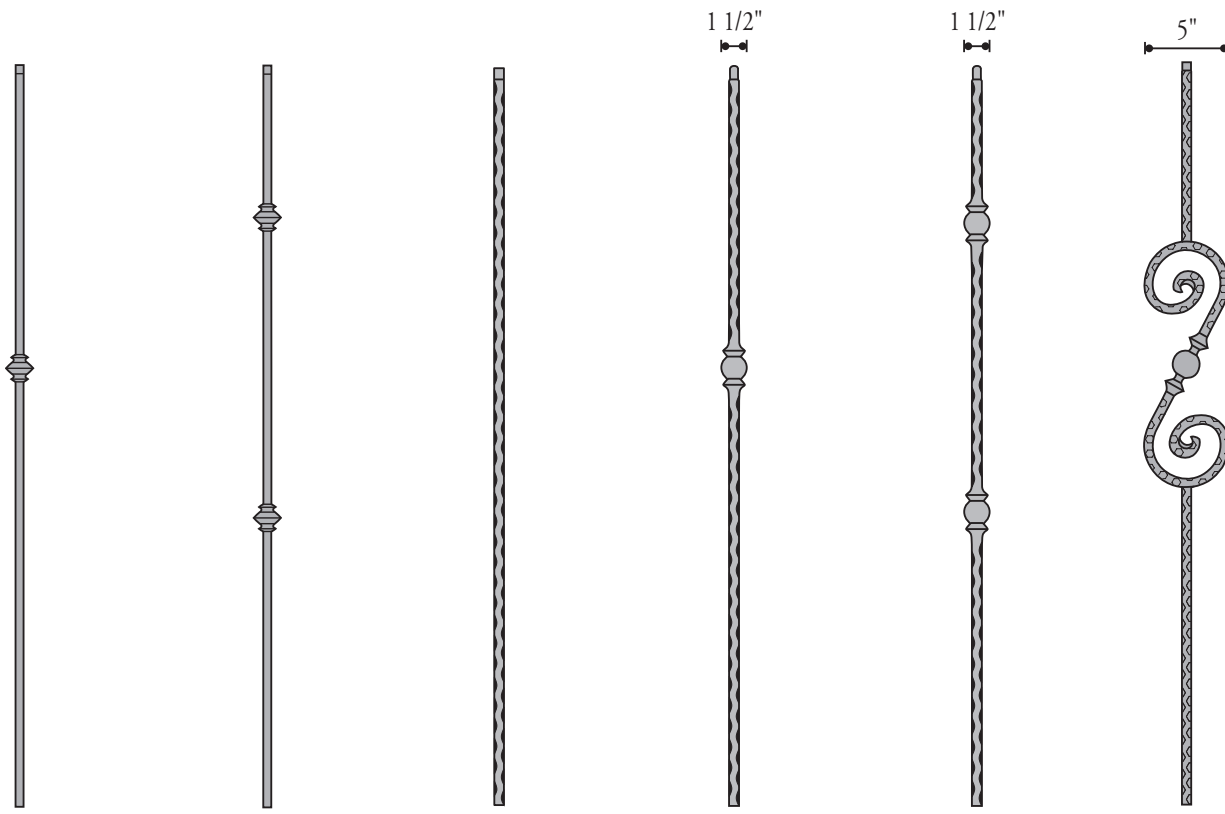

K-9006TB-44"  
1/2"

K-9007TB-44"  
1/2"

K-9031HF-44"  
9/16"

1 1/2"  
K-9032HF-44"  
9/16"

1 1/2"  
K-9033HF-44"  
9/16"

5"  
K-9034HF-44"  
9/16"

## AVAILABLE FINISHES

Colors shown may vary due to the translation and reproduction limitations of photography.



Satin Black



Ash Gray



Flat Black



Copper Vein



Silver Vein



Oil Rubbed Bronze



Oil Rubbed Copper

# LITE IRON BALUSTERS



K-9000TB-44"  
1/2"



K-9001TB-44"  
1/2"



K-9080TB-44"  
1/2"



K-9002TB-44"  
1/2"



K-9003TB-44"  
1/2"



K-9004TB-44"  
1/2"



K-9010RS-44"  
1/2"



K-9011RS-44"  
1/2"



K-9012RS-44"  
1/2"



K-9013RS-44"  
1/2"

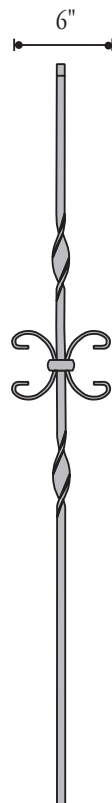

K-9014RS-44"  
1/2"

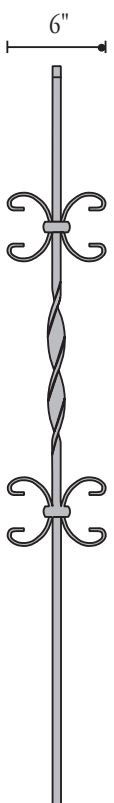

K-9015RS-44"  
1/2"



SBL K-9068RB-96  
9/16" x 96", Round, Hollow Bar, Satin Black



# LITE IRON BALUSTERS

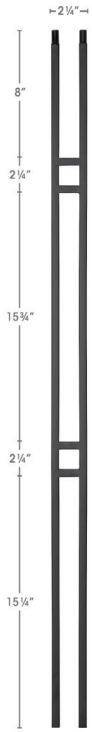

K-9087CS-44

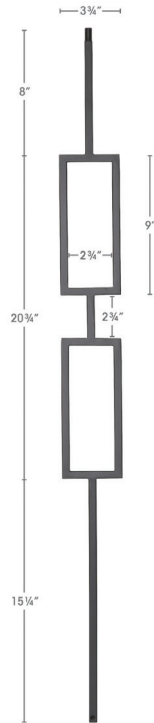

K-9091CS-44

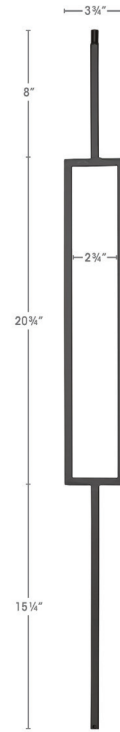

K-9089CS-44

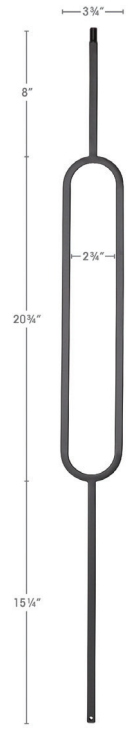

K-9088CS-44



# LITE IRON BALUSTERS

5 1/2"



K-9008TB-44"  
1/2"

7"



K-9009TB-44"  
1/2"

5"



K-9055SS-44"  
1/2"

6 3/4"



K-9057SS-44"  
1/2"

7"



K-9005TB-44"  
1/2"

5"



K-9045HF-44"  
9/16"



K-9046HF-44"  
9/16"



K-9047HF-44"  
9/16"

2 1/4"



K-9040HF-44"  
9/16"

2 1/4"



K-9041HF-44"  
9/16"



# LITE IRON BALUSTERS

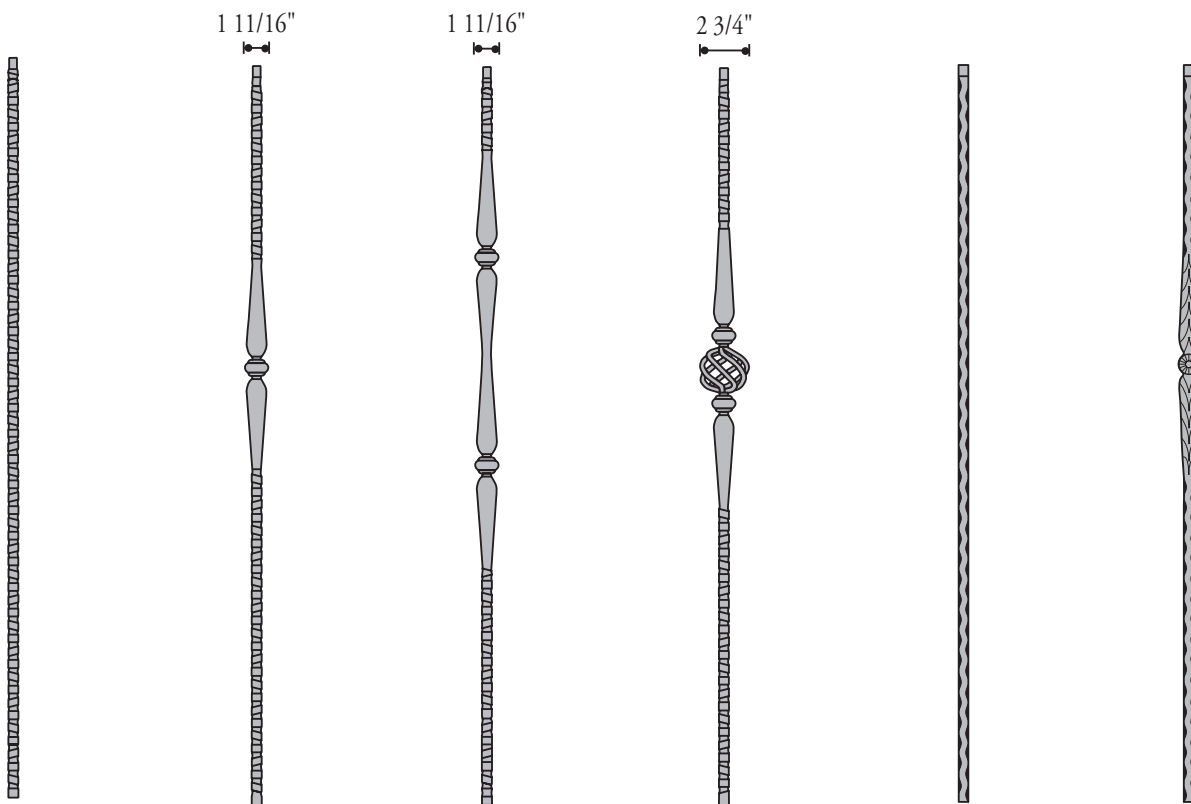

K-9016HG-44" 9/16"   
 K-9017HG-44" 1 11/16" 9/16"   
 K-9018HG-44" 1 11/16" 9/16"   
 K-9019HG-44" 2 3/4" 9/16"   
 K-9020HE-44" 9/16"   
 K-9021HE-44" 9/16"

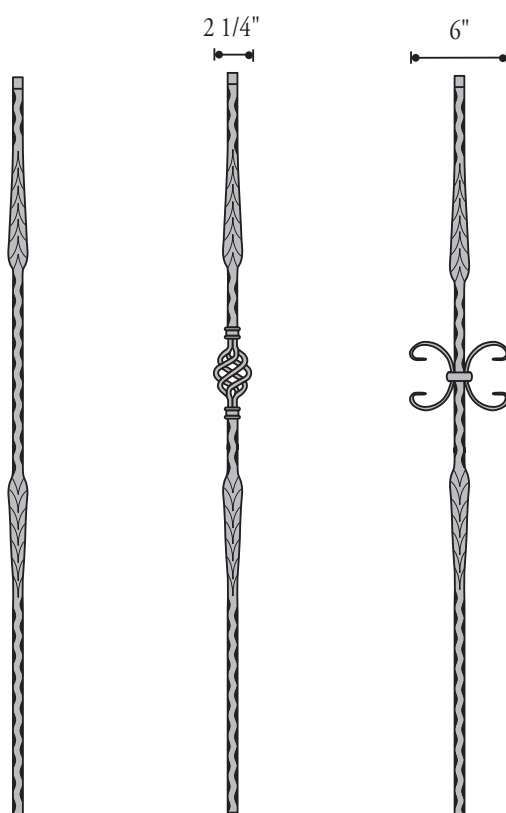

K-9022HE-44" 9/16"   
 K-9023HE-44" 2 1/4" 9/16"   
 K-9024HE-44" 6" 9/16"

## ACCESSORIES



Base Shoe K-9061BS - 1/2" K-9061BS - 9/16"   
 Base Shoe w/Set Screw K-9062BS - 1/2" K-9062BS - 9/16"   
 Rake Shoe w/Set Screw K-9063RS - 1/2" K-9063RS - 9/16"



Adjustable Knuckle K-9064AK - 1/2" K-9064AK - 9/16"   
 Flat Square Shoe K-9065FS - 1/2" K-9065FS - 9/16"   
 Shoe w/Down Ears K-9066DE - 1/2" K-9066DE - 9/16"



Flat Round w/Insert K-9067EF-FR Universal   
 Flat Square w/Insert K-9067EF-FS Universal

# BALUSTERS

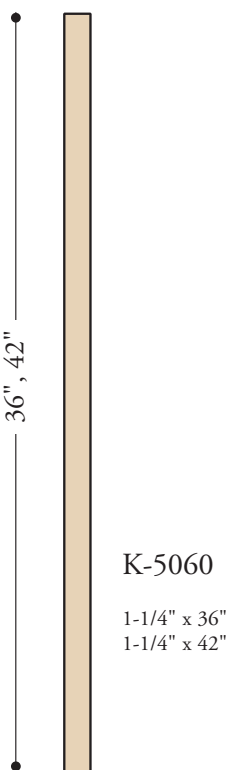
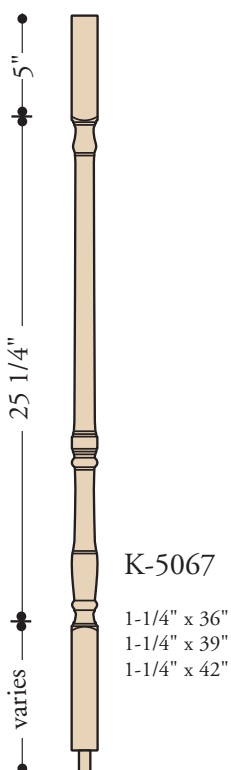
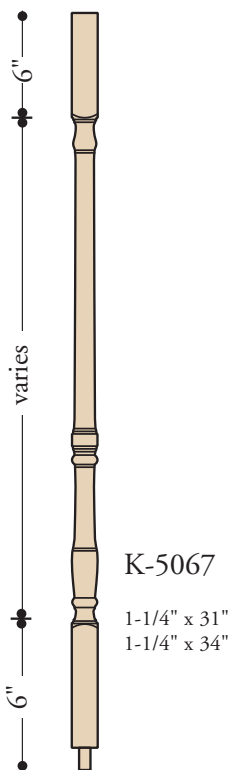
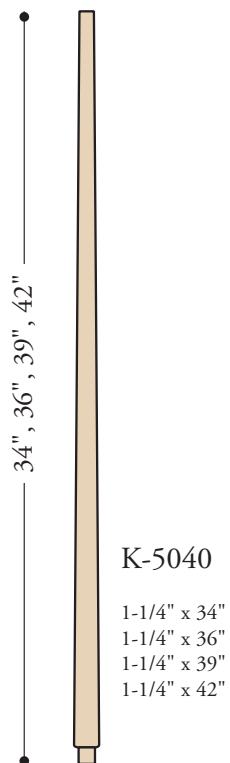
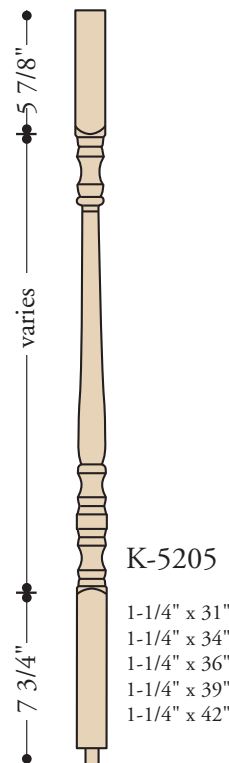
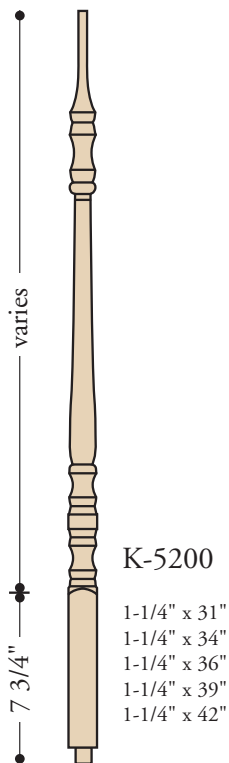
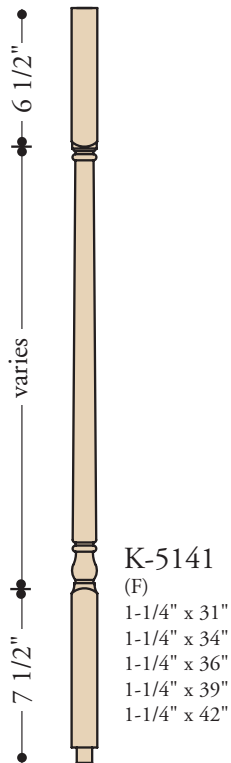
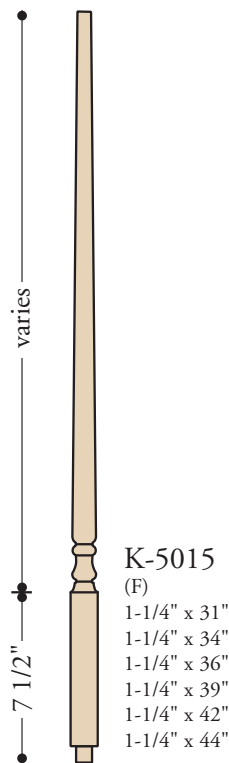

Several balusters and newels are also available in Reeded, Twisted, Fluted, and Octagonal as designated with a **R** (Reeded), **T** (Twisted), **F** (Fluted), or **O** (Octagonal) below the corresponding part numbers. Call for pricing and lead times.

# BALUSTERS

7 3/4" varies

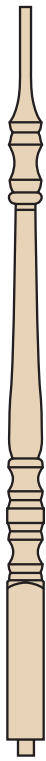

**K-5300**  
(F, R, O)  
1-3/4" x 31"  
1-3/4" x 34"  
1-3/4" x 36"  
1-3/4" x 39"  
1-3/4" x 42"  
1-3/4" x 48"  
(14" base)

5 7/8" varies



**K-5105**  
(O)  
1-3/4" x 31"  
1-3/4" x 34"  
1-3/4" x 36"  
1-3/4" x 39"  
1-3/4" x 42"  
1-3/4" x 48"  
(14" base)

6" varies 16 1/2"



**K-5005**  
(O)  
1-3/4" x 31"  
1-3/4" x 36"  
1-3/4" x 42"  
1-3/4" x 48"  
(14" base)

7 1/2" varies



**K-2015**  
(F, T, O)  
1-3/4" x 31"  
1-3/4" x 34"  
1-3/4" x 36"  
1-3/4" x 39"  
1-3/4" x 42"

5 3/4" varies 7 1/2"



**K-2005**  
(F, T, O)  
1-3/4" x 31"  
1-3/4" x 34"  
1-3/4" x 36"  
1-3/4" x 39"  
1-3/4" x 42"



28" varies



**K-2315**  
(F, R, O)  
1-3/4" x 36"  
1-3/4" x 42"

6 1/4" varies 19 1/2"



**K-2300**  
(F, R, O)  
1-3/4" x 36"  
1-3/4" x 42"

36", 42"



**K-5360**  
1-3/4" x 36"  
1-3/4" x 42"

# FITTINGS

## STARTING FITTINGS FOR K-6010 & K-6210 RAIL PROFILES

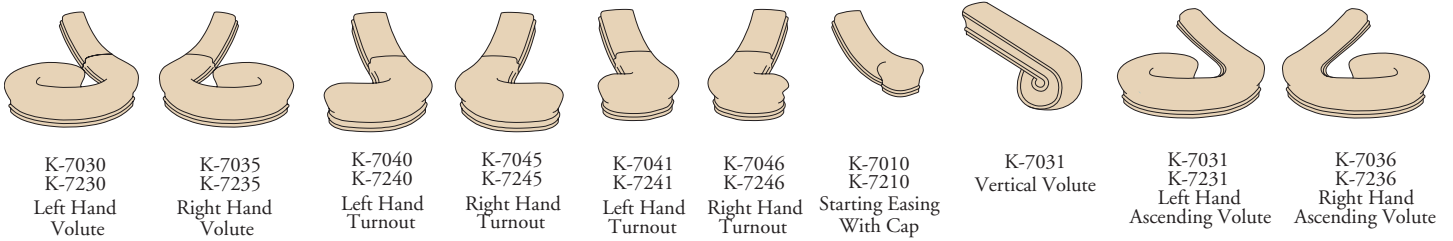

## TRANSITION FITTINGS FOR K-6010 & K-6210 RAIL PROFILES

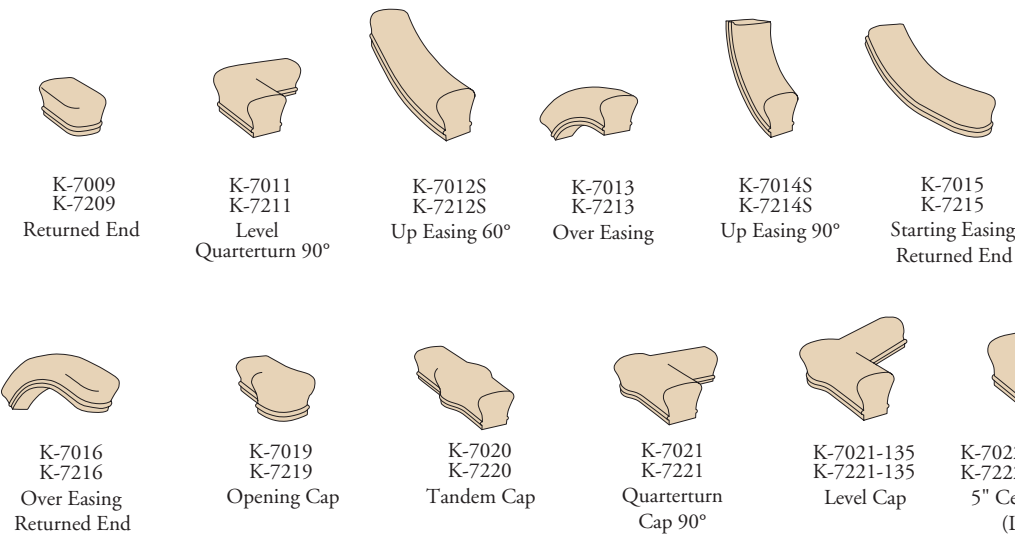

**HOW TO ORDER FITTINGS**  
 The second digit of the fitting part number must match the second digit of the rail part number.  
 Example:  
 K-70XX Fitting = K-6010 Rail  
 K-72XX Fitting = K-6210 Rail

## GOOSENECK FITTINGS FOR K-6010 & K-6210 RAIL PROFILES

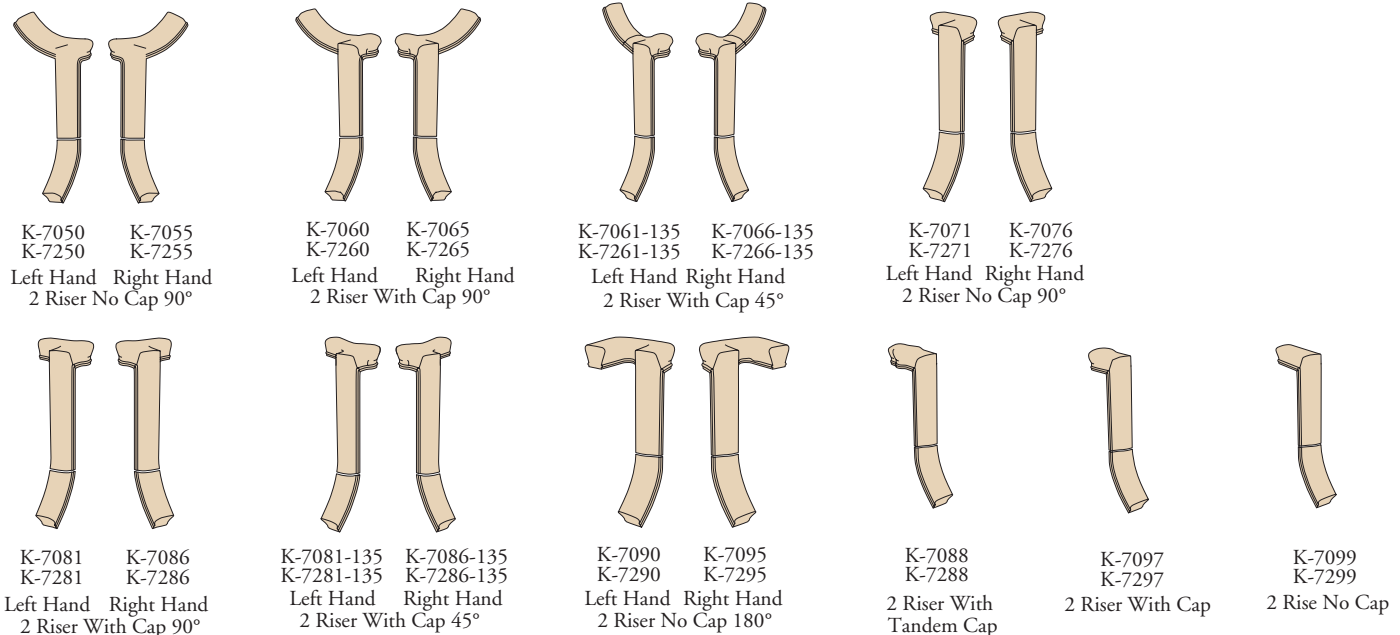

## STARTING FITTINGS FOR K-6519, 6710 & K-6910 RAIL PROFILES

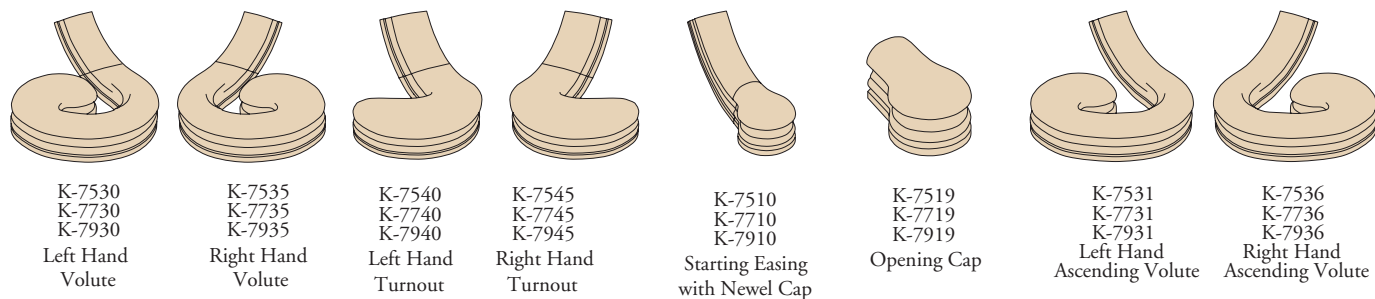

## TRANSITION FITTINGS FOR K-6519, 6710 & K-6910 RAIL PROFILES

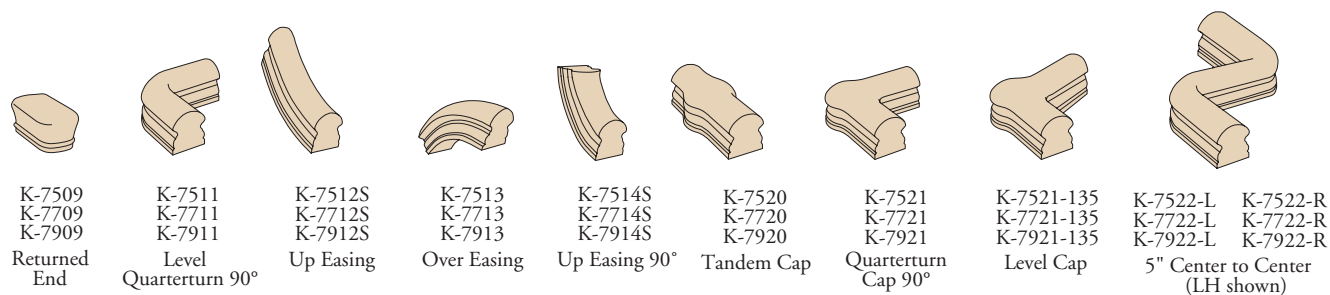

## GOOSENECK FITTINGS FOR K-6519, 6710 & K-6910 RAIL PROFILES

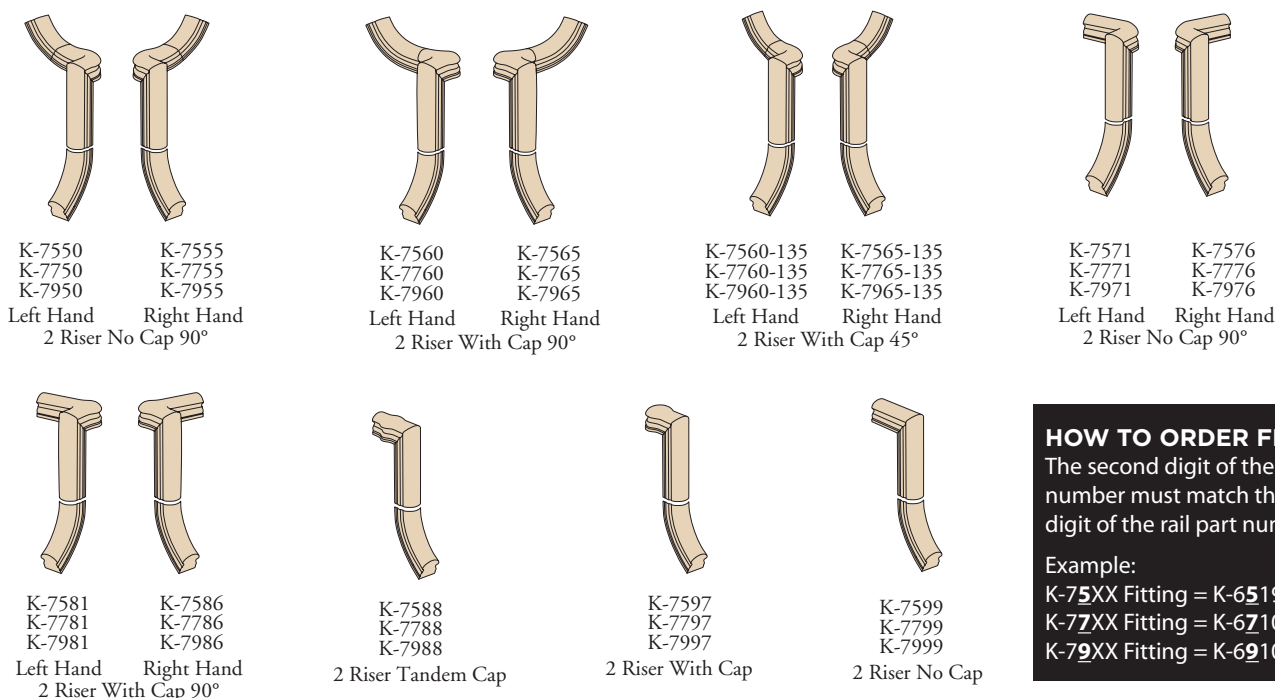

**HOW TO ORDER FITTINGS**  
 The second digit of the fitting part number must match the second digit of the rail part number.

Example:  
 K-75XX Fitting = K-6519 Rail  
 K-77XX Fitting = K-6710 Rail  
 K-79XX Fitting = K-6910 Rail

# TREADS, RISERS & ACCESSORIES

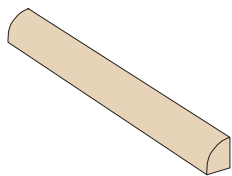

**Shoe Mould**  
1624-A  
1/2" x 3/4"

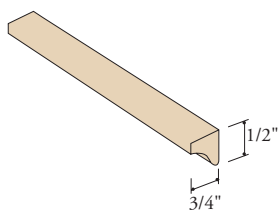

**Cove Mould**  
1624-C  
1/2" x 3/4"

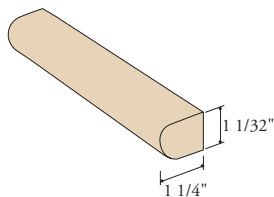

**Nosing**  
K-8080  
1-1/4" x 1-1/32"

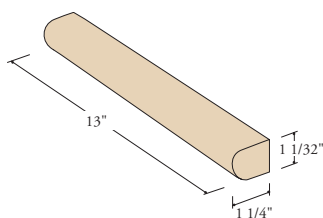

**13" Return Nosing**  
K-8080-13  
1-1/4" x 1-1/32"

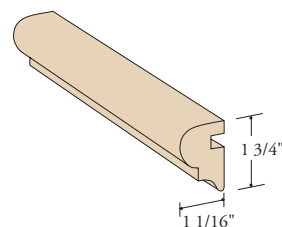

**Nosing and Cove**  
K-8081  
1-1/16" x 1-3/4"

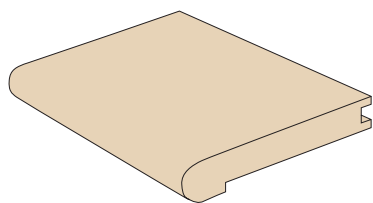

**5-1/4" Landing Tread**  
33168-34-LTG for 3/4" floor  
33168-12-LTG for 1/2" floor

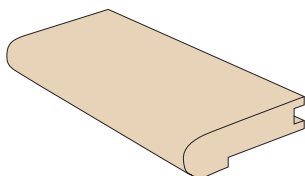

**3-1/2" Landing Tread**  
33112-34-LTG  
for 3/4" floor

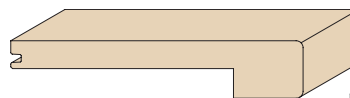

**5-1/4" Landing Tread**  
33168-12-2RE18-LTG  
for 1/2" floor

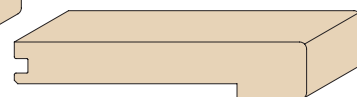

**5-1/4" Landing Tread**  
33168-34-2RE18-LTG  
for 3/4" floor

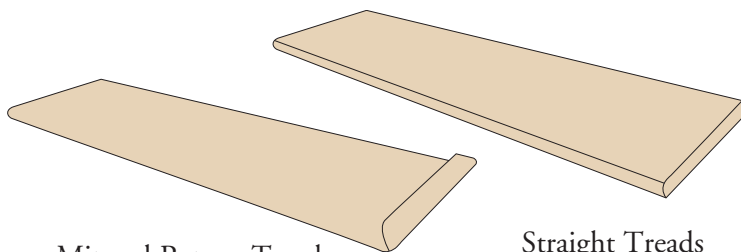

**Mitered Return Treads**  
Available with Single or  
Double Returned Ends  
(RH Shown)

**Straight Treads**

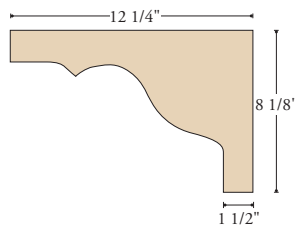

**Tread Bracket**  
K-8028  
1/4" thick

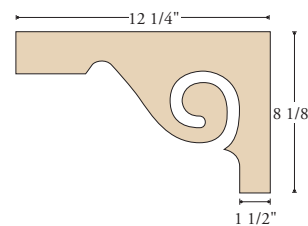

**Tread Bracket**  
K-8029  
1/4" thick

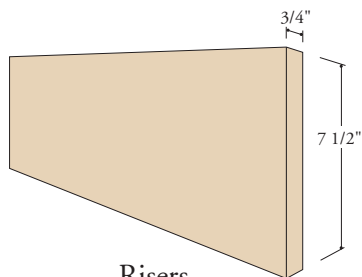

**Risers**

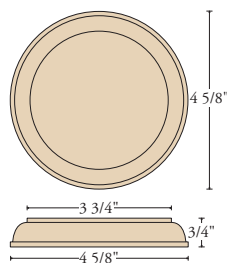

**Rosette**  
K-7317

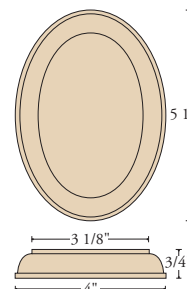

**Rosette**  
K-7337

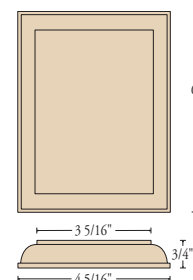

**Rosette**  
K-7318

## 11-1/4" SKIRTBOARDS

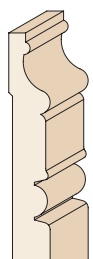

22360-E-B

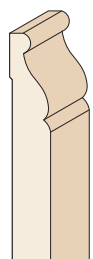

22360-CB

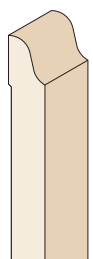

18360-OG-B

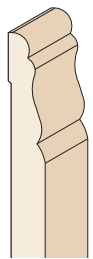

18360-B

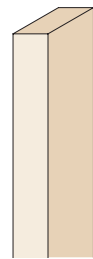

24360-S4S

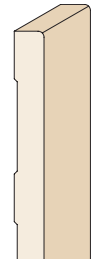

20360-1R18-B

# TREADS, RISERS & ACCESSORIES

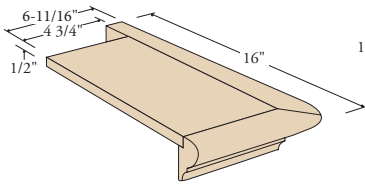

**Tread Cap w/Mitered Return**  
**K-8071**  
 4-3/4" x 11-1/2"  
 Specify LH or RH  
 (RH Shown)

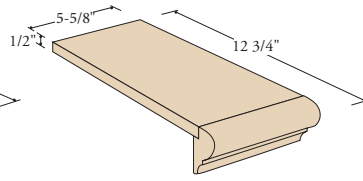

**Tread Cap**  
**K-8072**  
 4-3/4" x 11-1/2"

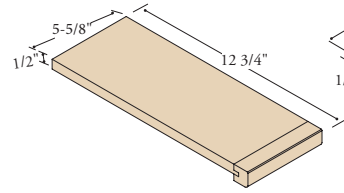

**K-8072-2RE18**  
 4-3/4" x 11-1/2"

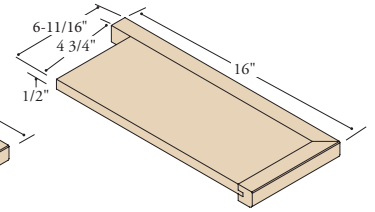

**K-8071-2RE18**  
 4-3/4" x 11-1/2"  
 Specify LH or RH  
 (RH Shown)

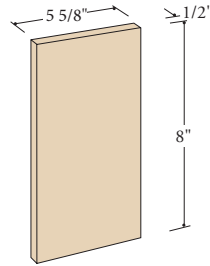

**Riser Cap**  
**K-8076**  
 4-3/4" x 8"

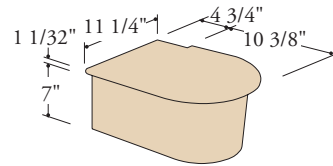

**Starting End Cap**  
**K-8011**  
 Specify LH or RH  
 (RH Shown)



# STARTING STEPS

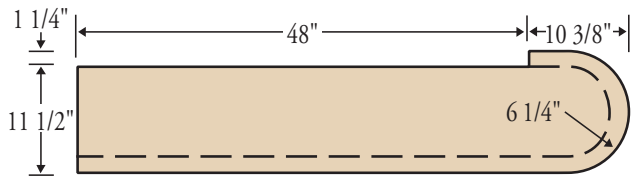

K-8010

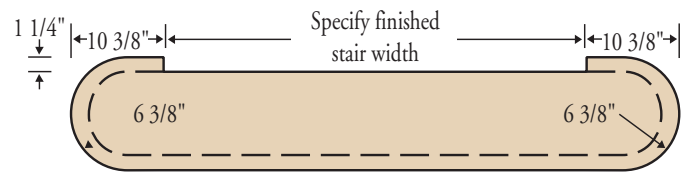

K-8015

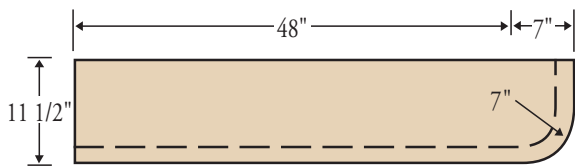

K-8040

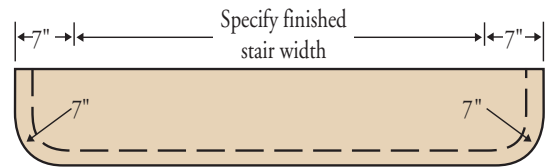

K-8060

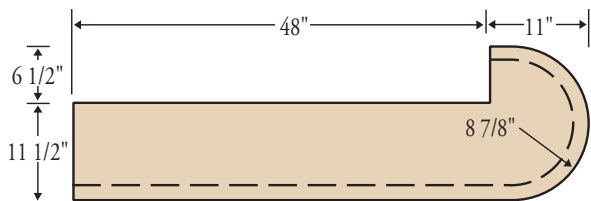

K-8030

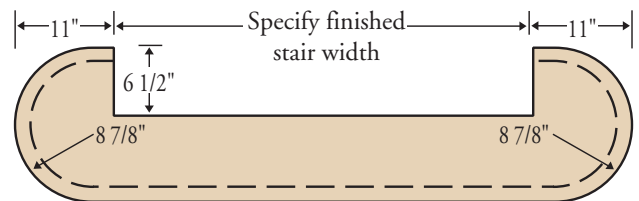

K-8050

All starting steps are shipped complete including the tread, riser, cove and shoe moulding.

Custom sized/shaped starting steps are available on a special order basis.



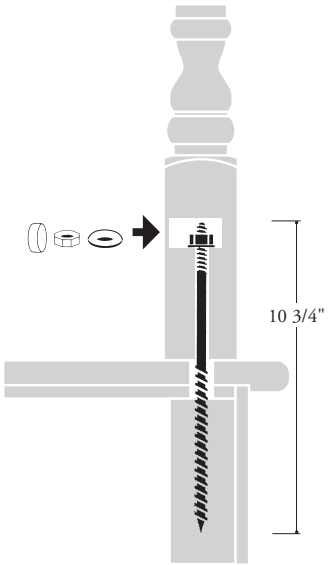

**K-3008**  
**Sure Tite**  
**Newel Fastening System**  
 Includes: Lag Bolt, Washer,  
 Nut & 1-1/2" Plugs

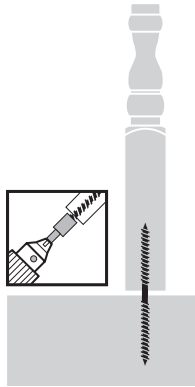

**K-201B**  
**1/4" Baluster Fastener**  
**Drill Driver**

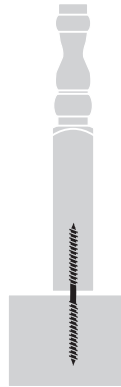

**K-3202**  
 20-pack  
**1/4" x 2" Baluster Fasteners**

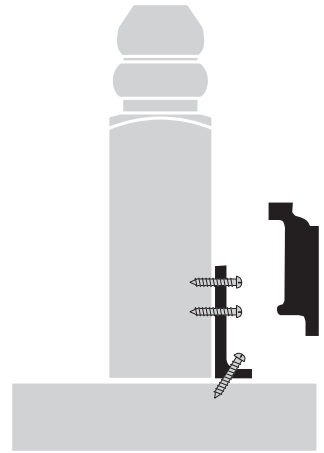

**K-3505-30 - 3"**  
**K3505-35 - 3-1/2"**  
**L-Bracket Post Fastener**

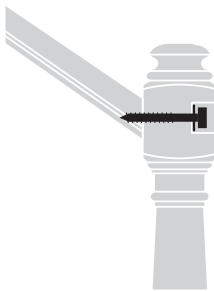

**K-3301**  
**Rail & Post Fastener**  
 Includes: Fastener, Washer,  
 Nut & 1" Plugs

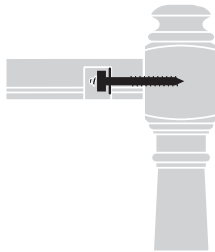

**K-3302**  
**Rail Bolt Fastener**  
 Includes: Fastener, Washer,  
 Nut & Plugs

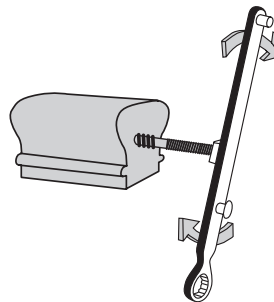

**K-3901**  
**Rail Bolt Wrench**

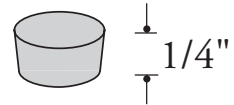

**K-3000**  
**Flush Rail Plug**  
 1" Diameter

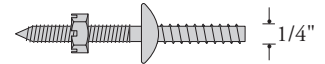

**K-3001**  
**3-1/2" Rail Bolt**

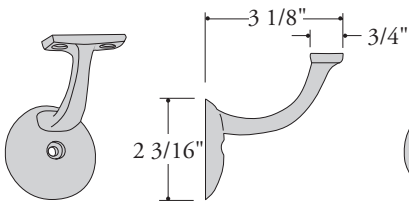

**K-3601**  
**Heavy Duty Wall**  
**Rail Bracket**  
 (Available in Antique Brass,  
 Bright Brass and Nickel Finish)

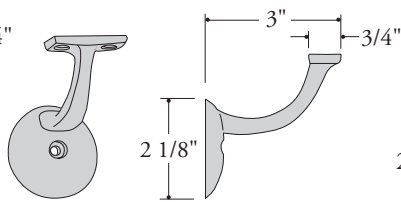

**K-9802**  
**Heavy Duty Wall**  
**Rail Bracket**  
 (Available in Matte Black,  
 Oil Rubbed Bronze, Satin Black  
 and Silver Vein Finish)

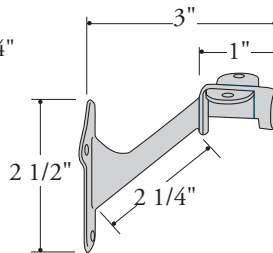

**K-3002**  
**Wall Rail Bracket**  
 (Brass Finish)

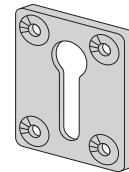

**K-3283**  
**Key Lock**  
 2" x 2-5/8" x 3/8"

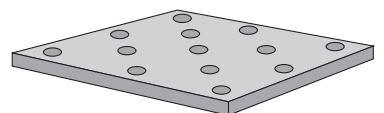

**K-3501**  
**4-5/8" Rail Plate**  
 Includes: Plate and  
 13-3" Fastening Screws

COVER IMAGE COURTESY OF:  
**ITC Millwork & Arcadia Homes**  
**Stallings/Raleigh, NC and Charleston, SC,**  
**Dustin Peck Photography, Charlotte, NC**

- Handrail: K-6302
- Balusters: K-9068RB-96

PAGE 4:

- Handrail: K-6710-ST
- Newel: K-4091-F
- Balusters: K-2015

PAGE 8:

- Handrail: K-6210-ST-P1, K-6210-B bending rail
- Newel: K-4091-FP
- Baluster: K-5360

PAGE 12:

- Handrail: K-6210-ST
- Newel: By Others (similar to K-4091)
- Baluster: K-9068RB-96
- Intermediate Baluster: 1-1/2" x 2" S4S

PAGE 13 - IMAGE COURTESY OF:

**ITC Millwork, Stallings/Raleigh, NC, Charleston, SC**  
**New Old, LLC, Charlotte, NC, Southern Studio, NC, and**  
**Michael Blevins Photography, Kernersville, NC**

- Baluster: K-9088CS-44, K-9000TB-44
- Rail & Newel: By Others

PAGE 17:

- Handrail: K-6210-ST, K-6210-ST-P1
- Baluster: K-5005
- Handrail: K-6210-ST-P1
- Newel: K-4091

PAGE 21 - IMAGE COURTESY OF:

**Home Lumber of New Haven, New Haven, IN**  
**Timberlin Homes, Ft. Wayne, IN**

- Handrail: K-6210-ST-P1
- Newel: K-4891-FP
- Balusters: K-5360

PAGE 24:

- Handrail: K-6210-P1
- Newels: By Others
- Balusters: K-9080TB-44 & K-9004TB-44







INTERIOR WOOD PRODUCTS

(614)504-5486

[www.IWPOHIO.com](http://www.IWPOHIO.com)