



STAIR PARTS



DOORS - MOULDINGS - STAIR PARTS
HARDWARE



Since 2010, Interior Wood Products has been the Midwest Region's most comprehensive source for architectural millwork and select building products. Interior Wood Products' unique manufacturing capabilities enable us to tailor or custom manufacture any item to ensure that you get exactly what you want. Quality service makes us your partner in your building project.

Our vast product offering serves the needs of leading multi-family and large development builders, custom builders, designers, remodelers, and individual homeowners. Interior Wood Products is a partnership of industry leading manufacturing, distribution, sales, logistics and business management entities. We guarantee effective cost management, the highest quality, and unmatched customer service.

TABLE OF CONTENTS

Rail, Shoe & Filet	1
Box Newels	2
Farmhouse Newels	3
Post to Post Newels	4 - 5
Over the Post Newels	6
Iron Newels	7
Lite Iron Balusters	8 - 13
Round Iron Balusters	14 - 15
Balusters	16 - 17
Fittings	18 - 19
Treads, Risers, & Accessories	20 - 21
Hardware	22
Stair System	23
Additional Products & Services	24

RAIL, SHOE & FILET

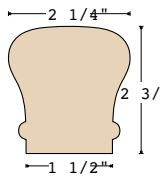

K-6010-ST

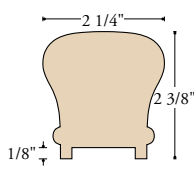

K-6010-ST-P1
1-1/4" plow

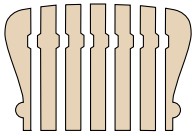

K-6010-B
Includes bending mould

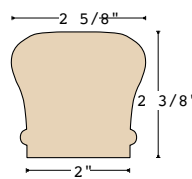

K-6210-ST

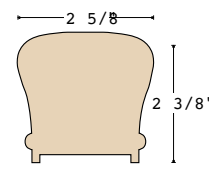

K-6210-ST-P1
1-3/4" plow

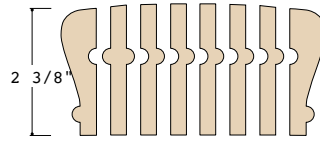

K-6210-B
Includes bending mould

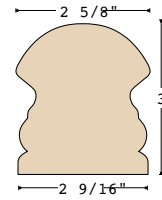

K-6519-ST

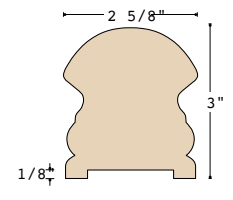

K-6519-ST-P1
1-3/4" plow

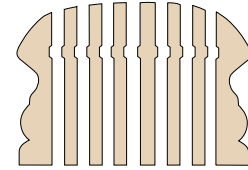

K-6519-B
Includes bending mould

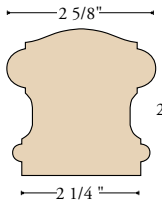

K-6710-ST

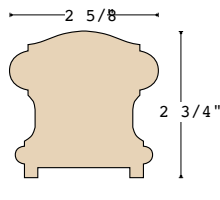

K-6710-ST-P1
1-3/4" plow

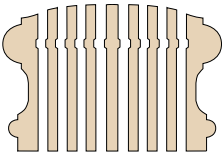

K-6710-B
Includes bending mould

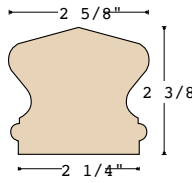

K-6910-ST

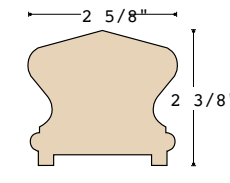

K-6910-ST-P1
1-3/4" plow

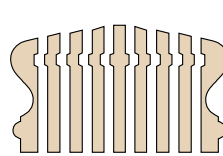

K-6910-B
Includes bending mould

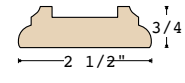

K-6045
1-1/4" plow

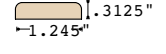

K-6000

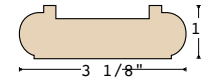

K-6006
1-3/4" plow

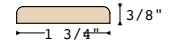

K-6007

ADDITIONAL RAIL PROFILES (BENDING RAIL & FITTING NOT AVAILABLE)

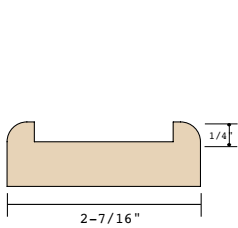

*K-6002-P1
1-3/4" plow

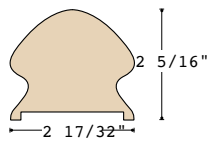

*K-6005-ST-P1
1-3/4" plow

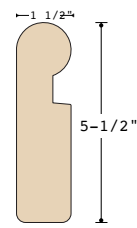

K-6035

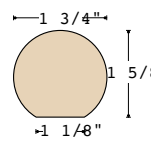

K-6040

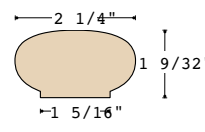

K-6042

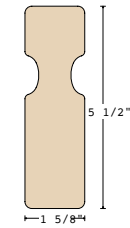

K-6300

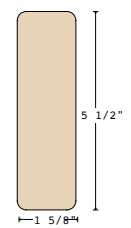

*K-6301

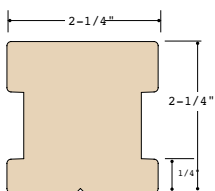

K-6350-ST

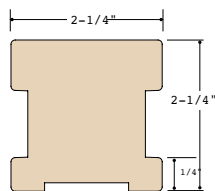

K-6350-ST-P
1-1/4" plow

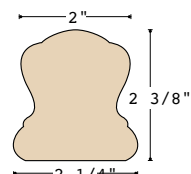

K-6510-ST

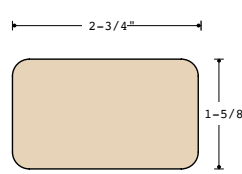

*K-6700

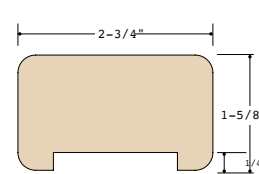

*K-6700-P1
1-3/4" plow

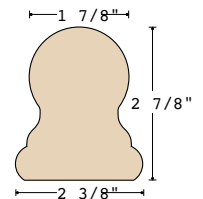

K-6810-ST

* = These handrail profiles may not comply with your local building codes.

BOX NEWELS

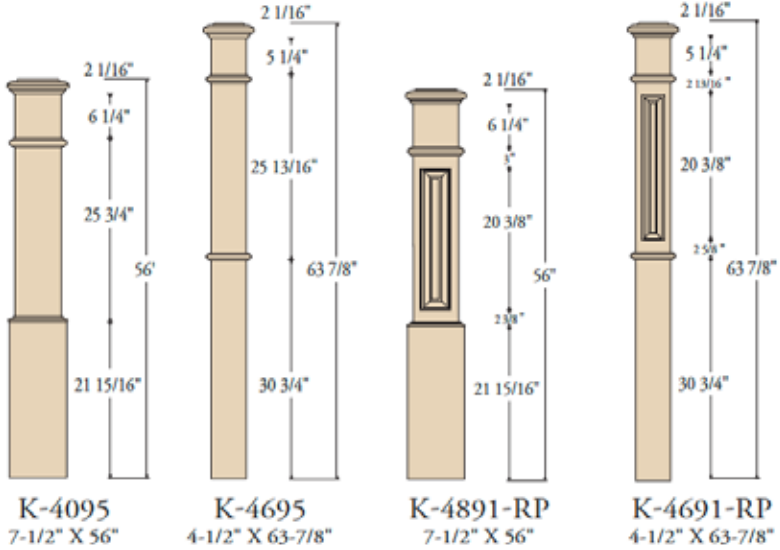
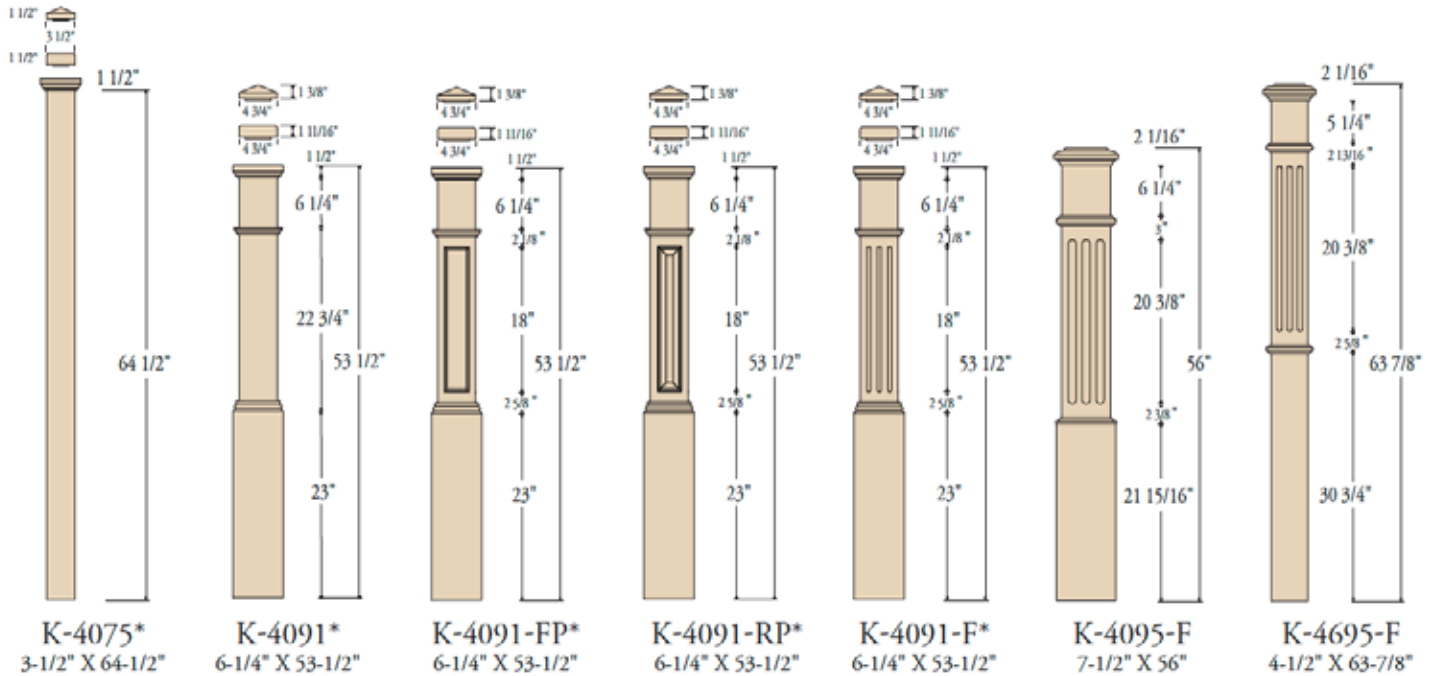

* These Box Newels are shipped with interchangeable flat and peak caps.

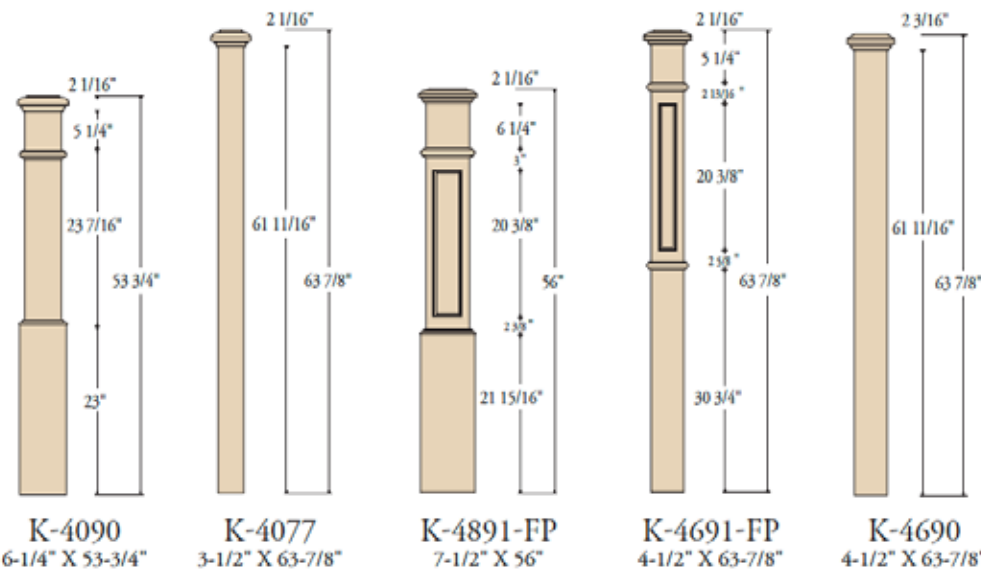

Mounting block and lag screws are included with all hollow box newels.

All box newels which are 4-1/2" and larger are hollow.

FARMHOUSE NEWELS

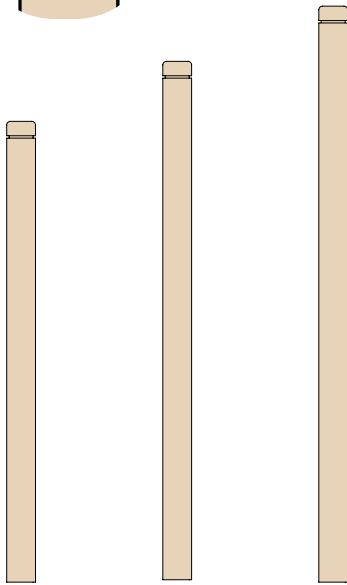

K-4102-48 3" x 3" x 48"
K-4102-54 3" x 3" x 54"
K-4102-60 3" x 3" x 60"

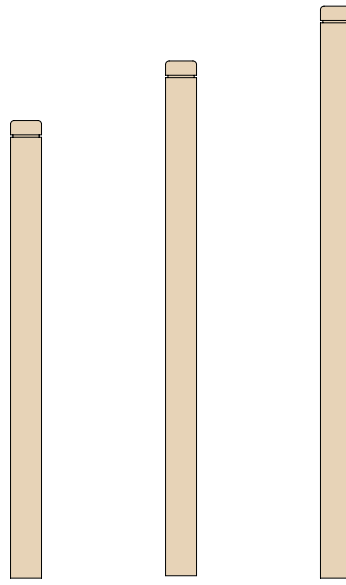

K-4202-48 3-1/4" x 3-1/4" x 48"
K-4202-54 3-1/4" x 3-1/4" x 54"
K-4202-60 3-1/4" x 3-1/4" x 60"

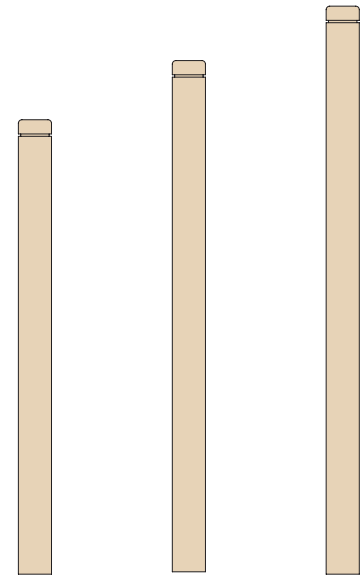

K-4302-48 3-1/2" x 3-1/2" x 48"
K-4302-54 3-1/2" x 3-1/2" x 54"
K-4302-60 3-1/2" x 3-1/2" x 60"

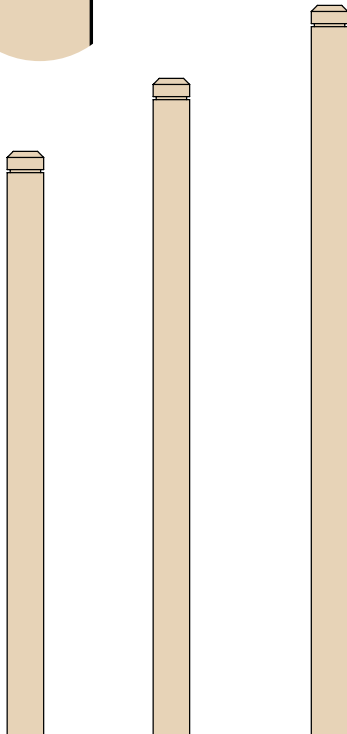
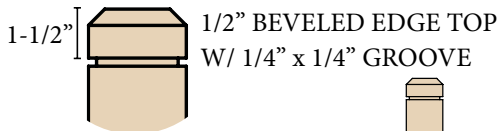

K-4402-48 3" x 3" x 48"
K-4402-54 3" x 3" x 54"
K-4402-60 3" x 3" x 60"

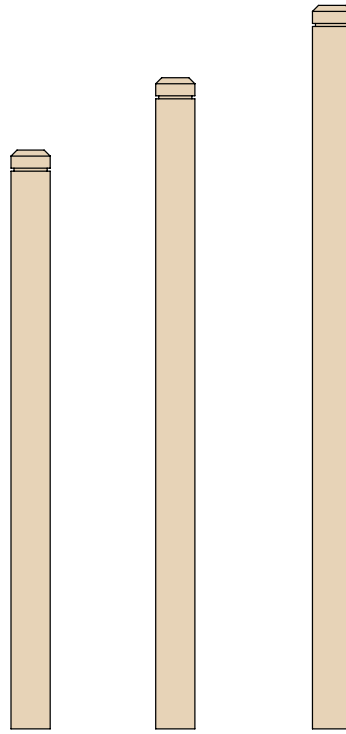

K-4502-48 3-1/4" x 3-1/4" x 48"
K-4502-54 3-1/4" x 3-1/4" x 54"
K-4502-60 3-1/4" x 3-1/4" x 60"

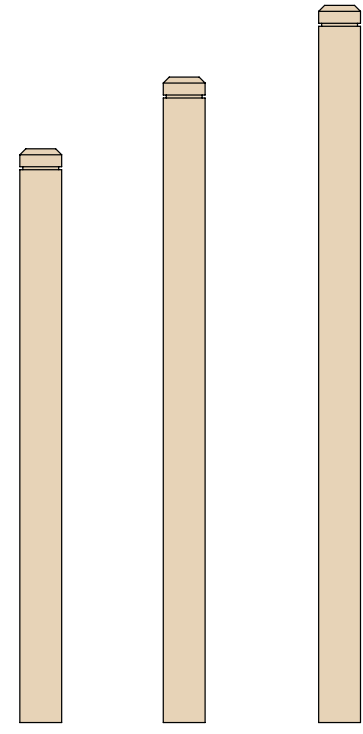

K-4602-48 3-1/2" x 3-1/2" x 48"
K-4602-54 3-1/2" x 3-1/2" x 54"
K-4602-60 3-1/2" x 3-1/2" x 60"

POST TO POST NEWELS

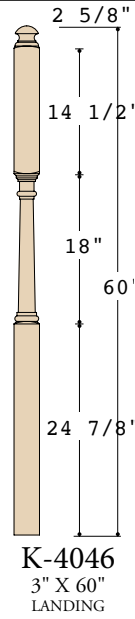
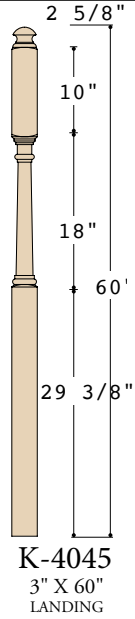
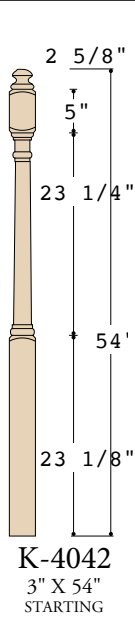
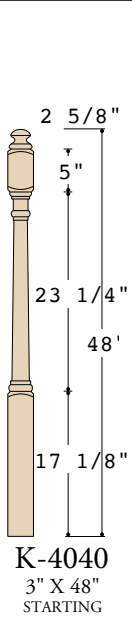

All "404X" newel posts featured on this page are available with a ball top. Specify BT when ordering.

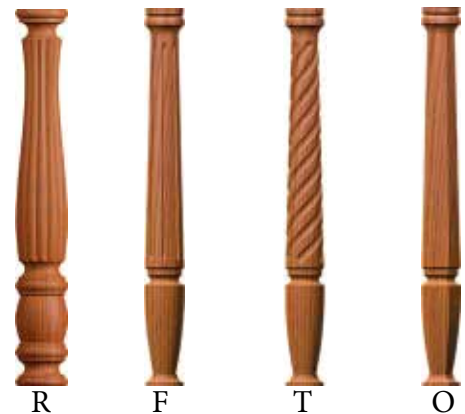
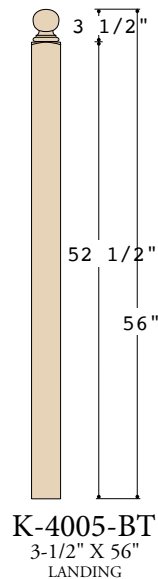
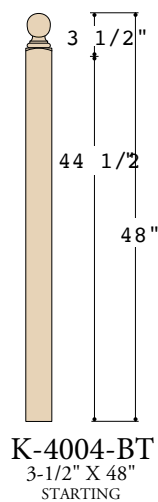
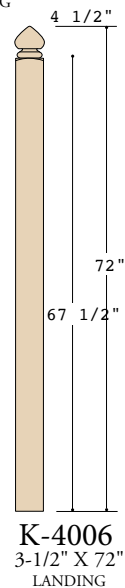
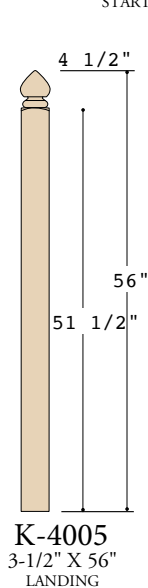
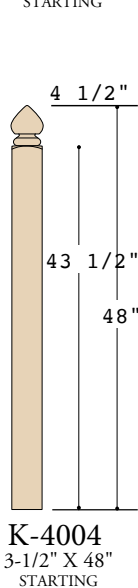
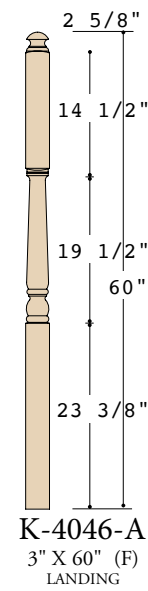
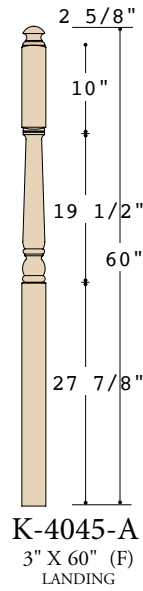
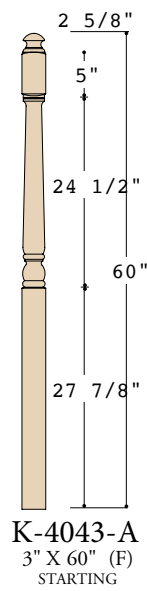
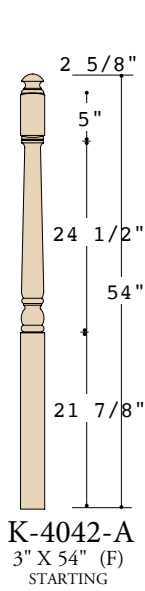
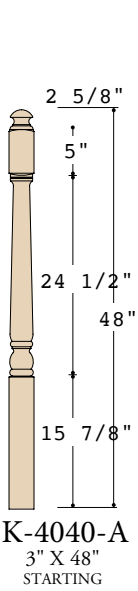

Several balusters and newels are also available in Reeded, Twisted, Fluted & Octagonal.

POST TO POST NEWELS

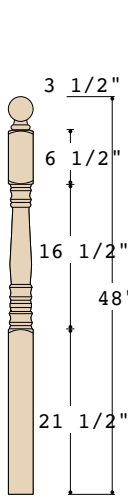

K-4300
3" X 48"
STARTING

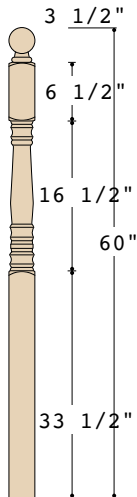

K-4304
3" X 60"
STARTING/LANDING

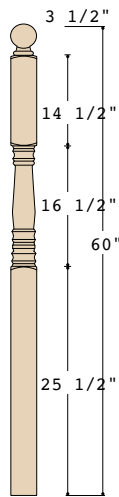

K-4305
3" X 60"
LANDING

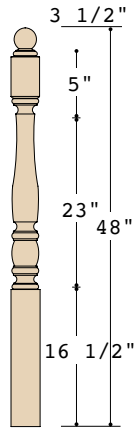

K-5548
3-1/2" X 48"
(F, R, O)
STARTING

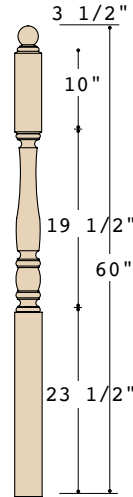

K-5545
3-1/2" X 60"
(F, R, O)
LANDING

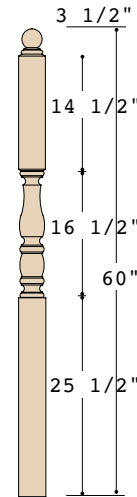

K-5546
3-1/2" X 60"
(F, R, O)
LANDING

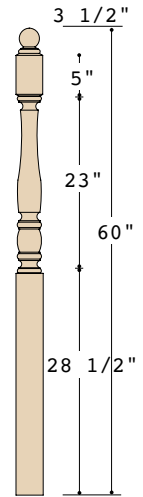

K-5560
3-1/2" X 60"
(F, R, O)
STARTING/LANDING

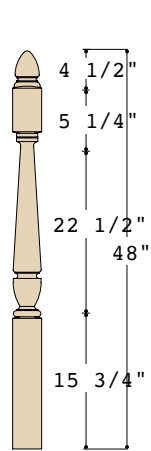

K-3030-ST
3-1/2" X 48"
(F, T, O)
STARTING

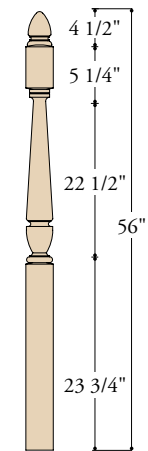

K-3042-ST
3-1/2" X 56"
(F, T, O)
STARTING/LANDING

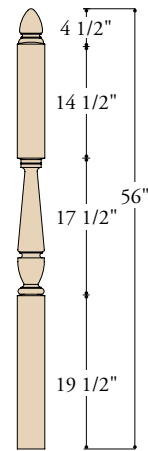

K-3046-ST
3-1/2" X 56"
(F, T, O)
LANDING

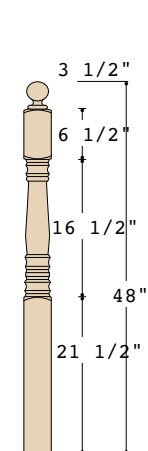

K-4500
3-1/2" X 48" (O)
STARTING

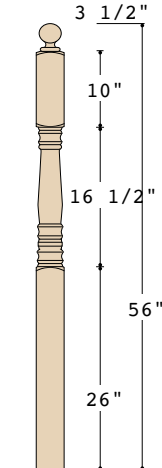

K-4503
3-1/2" X 56" (O)
LANDING

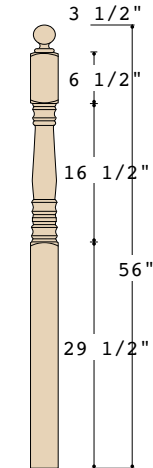

K-4504
3-1/2" X 56" (O)
STARTING/LANDING

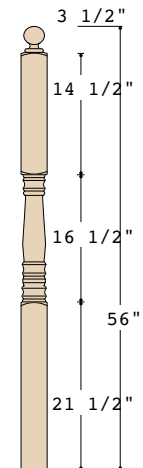

K-4505
3-1/2" X 56" (O)
STARTING

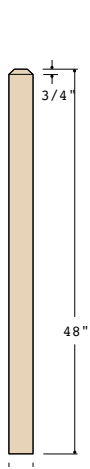

K-4002-48
3-1/2" X 48"
STARTING

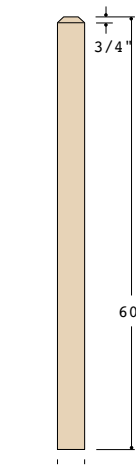

K-4002-60
3-1/2" X 60"
LANDING

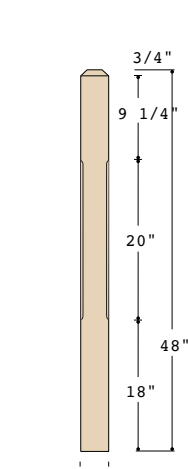

K-4002-C-48
3-1/2" X 48"
STARTING

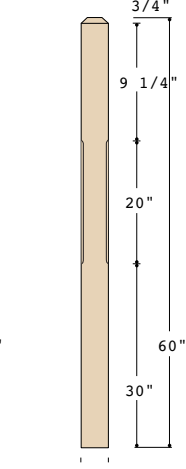

K-4002-C-60
3-1/2" X 60"
LANDING

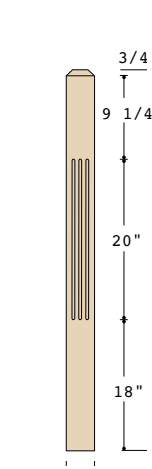

K-4002-F-48
3-1/2" X 48"
STARTING

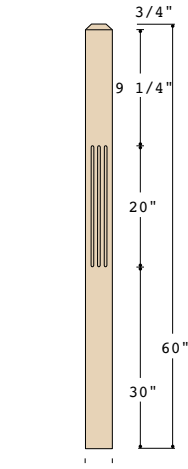

K-4002-F-60
3-1/2" X 60"
LANDING



K-4003-S4S 48
3-1/2" X 48"
S4S SQUARE



K-4003-S4S 60
3-1/2" X 60"
S4S SQUARE

OVER THE POST NEWELS

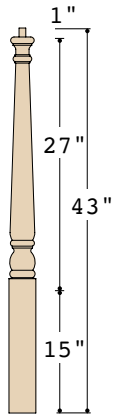

K-4010
3" X 43" (F)
STARTING
(Square Base)

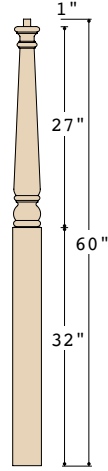

K-4015
3" X 60" (F)
LANDING
(Square Base)

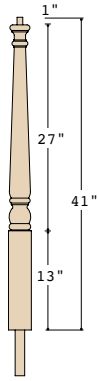

K-4050-RB
3" X 41" (F)
STARTING
(Round base, loose dowel)

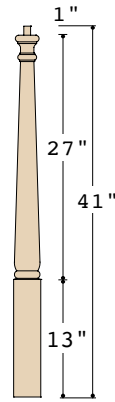

K-4061-41
3" X 41"
STARTING
(Square Base)

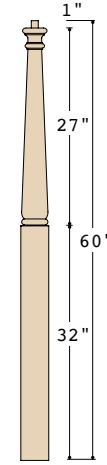

K-4061-60
3" X 60"
LANDING
(Square Base)

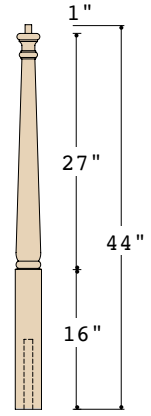

K-4061-RB
2-3/4" X 44"
STARTING
(Round base, loose dowel)

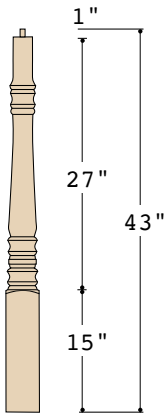

K-4270
3-1/2" X 43" (O)
STARTING
(Square Base)

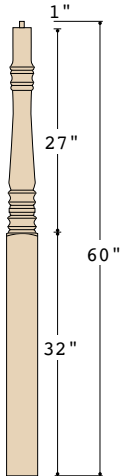

K-4275
3-1/2" X 60" (O)
LANDING
(Square Base)

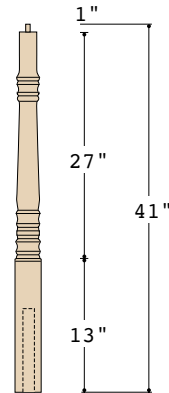

K-4272-RB
3-1/2" X 41" (O)
VOLUTE
(Round base, loose dowel)

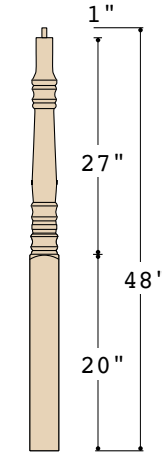

K-4271
3-1/2" X 48" (O)
STARTING
(Square Base)

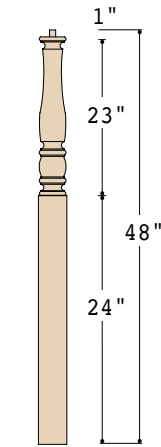

K-5511
3-1/2" X 48" (F, R, O)
STARTING
(Square Base)

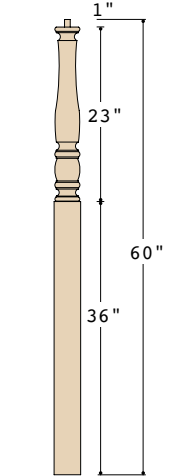

K-5515
3-1/2" X 60" (F, R, O)
LANDING
(Square Base)

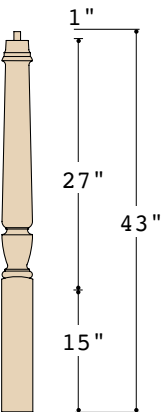

K-3010
3-1/2" X 43" (F, T)
STARTING
(Square Base)

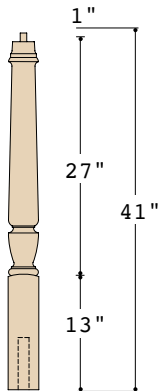

K-3012
3-1/2" X 41" (F, T)
STARTING
(Square base, loose dowel)

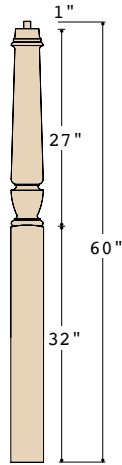

K-3015
3-1/2" X 60" (F, T)
LANDING
(Square Base)

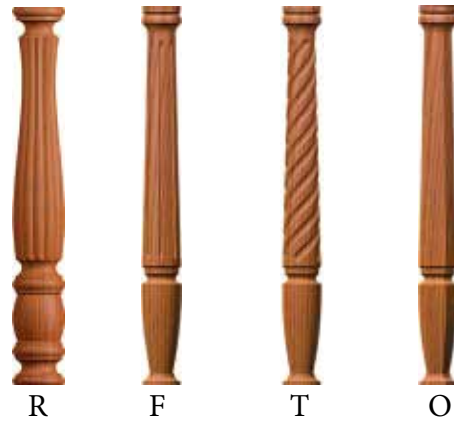

Several balusters and newels are also available in Reeded, Twisted, Fluted & Octagonal.

IRON NEWELS



NEWL-
140GOTHIC



NEWL-
BASK48



NEWL-
RIB48



NEWL-
TW48



NC101
Newel Anchoring
System w/ Shoe

IRON NEWEL ANCHORING SYSTEM

Available in 7 Finishes:

- Satin Black (SB)
- Flat Black (B)
- Antique Bronze (ABZ)
- Grey-Black (PC)
- Oil-Rub Copper (ORC)
- Nickel Verde (NV)
- Oil Rub Bronze (ORB)

LITE IRON BALUSTERS



K-9000TB-44"
1/2"



K-9001TB-44"
1/2"



K-9080TB-44"
1/2"



K-9002TB-44"
1/2"



K-9003TB-44"
1/2"



K-9004TB-44"
1/2"

AVAILABLE FINISHES Colors shown may vary due to the translation and reproduction limitations of photography.



SATIN BLACK



ASH GRAY



FLAT BLACK



COPPER VEIN



SILVER VEIN



OIL RUBBED BRONZE



OIL RUBBED COPPER

LITE IRON BALUSTERS



K-9005TB-44"
1/2"



K-9008TB-44"
1/2"



K-9009TB-44"
1/2"



K-9055SS-44"
1/2"



K-9057SS-44"
1/2"



K-9010RS-44"
1/2"



K-9011RS-44"
1/2"



K-9012RS-44"
1/2"



K-9013RS-44"
1/2"



K-9014RS-44"
1/2"



K-9015RS-44"
1/2"

LITE IRON BALUSTERS



SBL K-9068RB-96
9/16" x 96", Round Hollow Bar, Satin Black



K-9050VS-44



K-9051VS-44

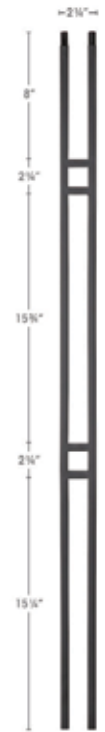

K-9087CS-44

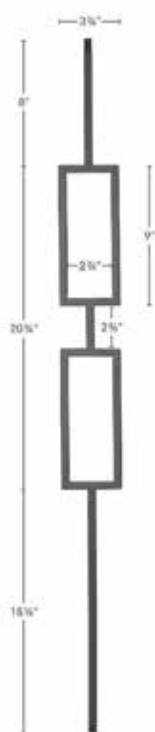

K-9091CS-44



K-9093CS-44

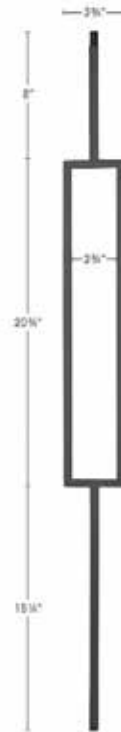

K-9089CS-44



K-9088CS-44

LITE IRON BALUSTERS



K-9006TB-44"
1/2"



K-9007TB-44"
1/2"



K-9031HF-44"
9/16"



K-9032HF-44"
9/16"



K-9033HF-44"
9/16"



K-9034HF-44"
9/16"



K-9045HF-44"
9/16"



K-9046HF-44"
9/16"



K-9047HF-44"
9/16"



K-9040HF-44"
9/16"



K-9041HF-44"
9/16"

LITE IRON BALUSTERS

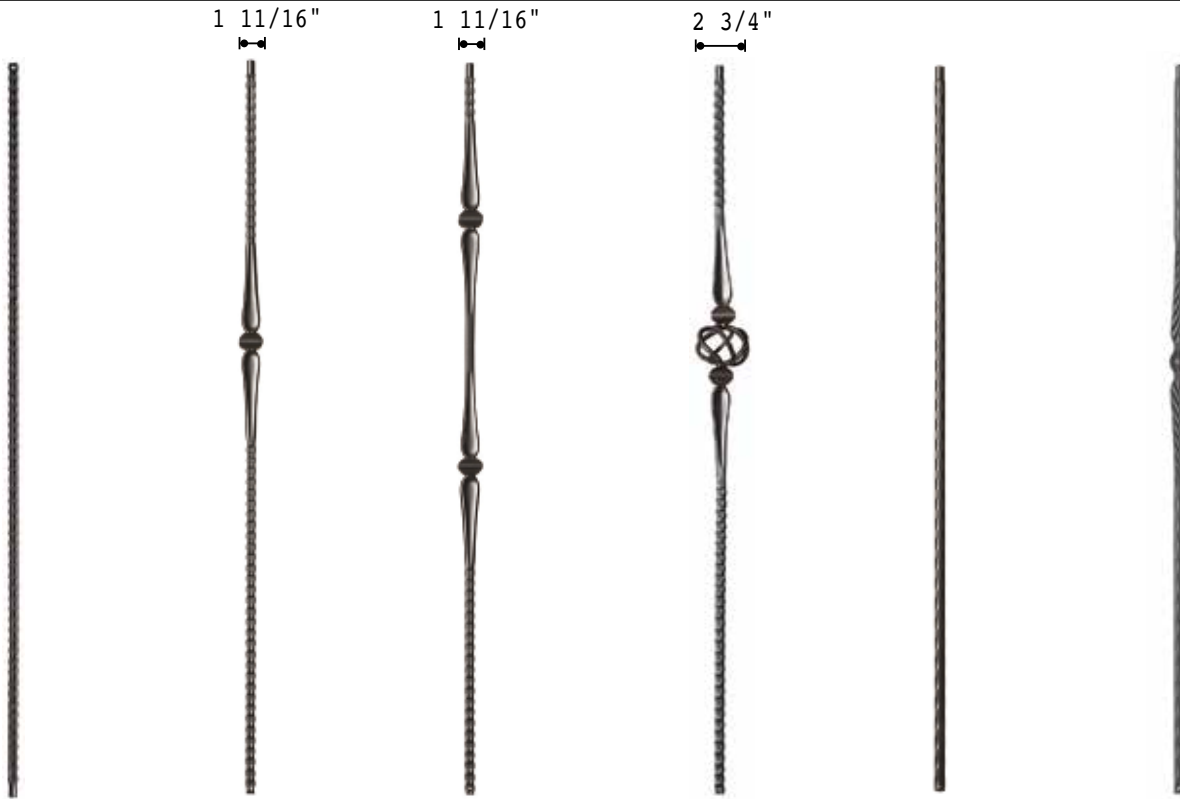

K-9016HG-44"
9/16"

K-9017HG-44"
9/16"

K-9018HG-44"
9/16"

K-9019HG-44"
9/16"

K-9020HE-44"
9/16"

K-9021HE-44"
9/16"



K-9022HE-44"
9/16"

K-9023HE-44"
9/16"

K-9024HE-44"
9/16"

ACCESSORIES



Base Shoe
K-9061BS - 1/2"
K-9061BS - 9/16"

Base Shoe w/Set Screw
K-9062BS - 1/2"
K-9062BS - 9/16"
K-9062BS - 3/4"

Rake Shoe w/Set Screw
K-9063RS - 1/2"
K-9063RS - 9/16"
K-9063RS - 3/4"



Adjustable Knuckle
K-9064AK - 1/2"
K-9064AK - 9/16"



Flat Square Shoe
K-9065FS - 1/2"
K-9065FS - 9/16"



Shoe w/Down Ears
K-9066DE - 1/2"
K-9066DE - 9/16"



Flat Round w/Insert
K-9067EF-FR
Universal



Flat Square w/Insert
K-9067EF-FS
Universal



K-5912 Insert
.42"x.42"x2"
(for 1/2" Balusters)

3/4" MEGA LITE IRON BALUSTERS



K-9900TB-44"
3/4"



K-9901TB-44"
3/4"



K-9902TB-44"
3/4"



K-9903TB-44"
3/4"



K-9904TB-44"
3/4"



K-9906TB-44"
3/4"



K-9907TB-44"
3/4"



K-9981TB-44"
3/4"

ROUND IRON BALUSTERS

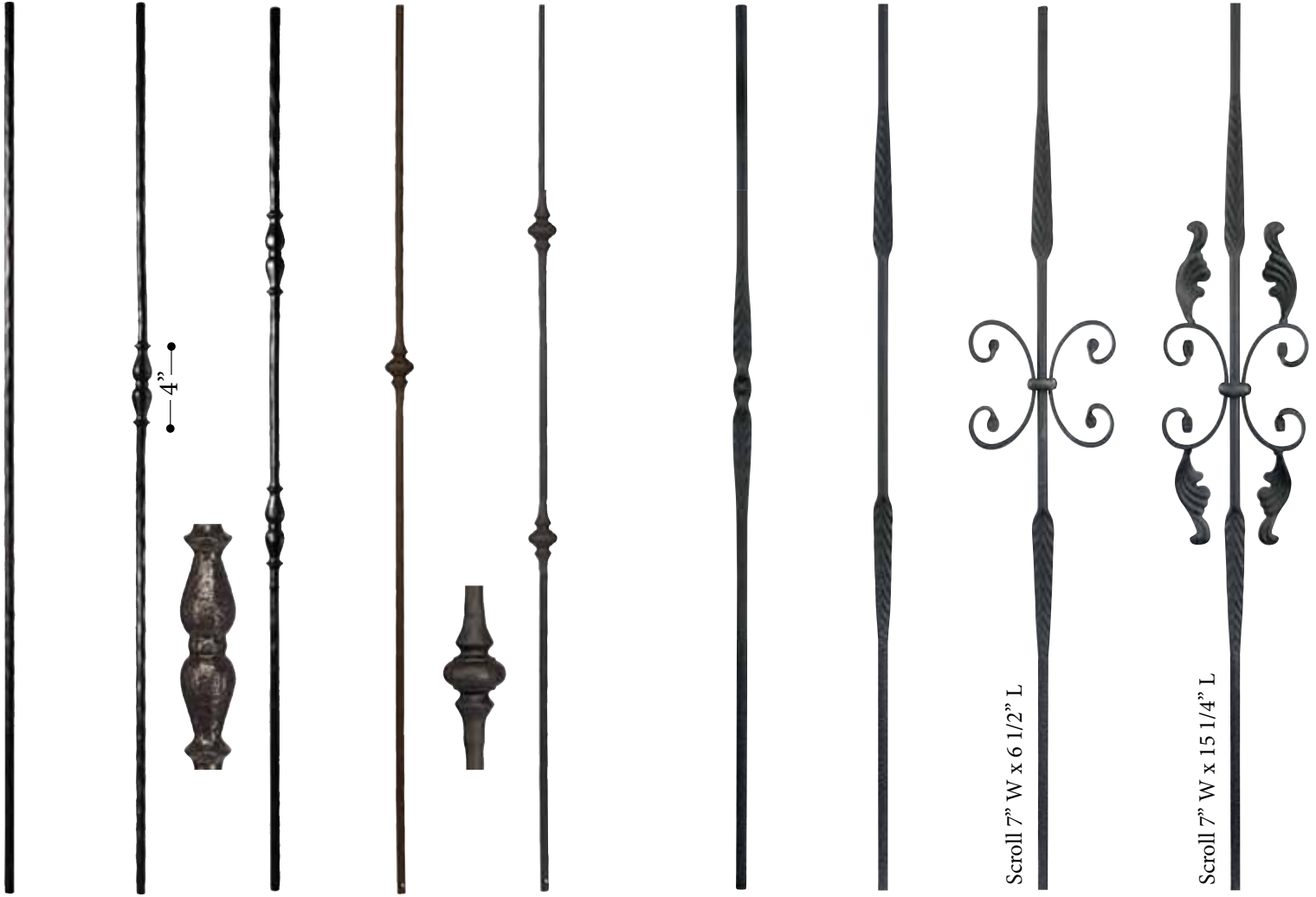

R60044	R60144	R60244	R61144	R61244	R20044	R21044	R22044	R22544
N/A in NV	N/A in NV	N/A in NV	N/A in NV	N/A in NV	B Only	B Only	B Only	B Only

1/2" BALUSTER THICKNESS (TEXTURED)

9/16" BALUSTER THICKNESS

AVAILABLE FINISHES

B
Flat Black
(lightly textured)

SAT
Satin Black
(smooth texture)

PC
Grey Black



ABZ
Antique Bronze

NV
Nickel Verde
(hand rubbed)

ORC
Oil Rubbed Copper
(hand rubbed)

ORB
Oil Rubbed Bronze
(hand rubbed)

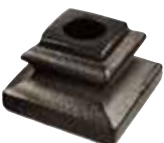
IRON SHOES
for 1/2" & 9/16" Round Installations

For 1/2" round balusters: R08F & R09P (N/A in NV)
For 9/16" round balusters: R07F & R06P (B Only)
Shoe Base Dimensions: 1 1/2" Square & 1 1/4" Square

ROUND IRON BALUSTERS



R54344
B Only

R54044
B Only

R55044
B Only

R-65044
N/A in NV

R-65244
N/A in NV

R-65644
N/A in NV

R-65844
N/A in NV

7"
22"

9/16" BALUSTER THICKNESS

5/8" ROUND

AVAILABLE FINISHES

B
Flat Black
(lightly textured)

SAT
Satin Black
(smooth texture)

PC
Grey Black

ABZ
Antique Bronze

NV
Nickel Verde
(hand rubbed)

ORC
Oil Rubbed Copper
(hand rubbed)

ORB
Oil Rubbed Bronze
(hand rubbed)



FLAT ROUND SHOE
Designed for Venetian style 2" diameter
(pitched shoe not available)

R10

BALUSTERS

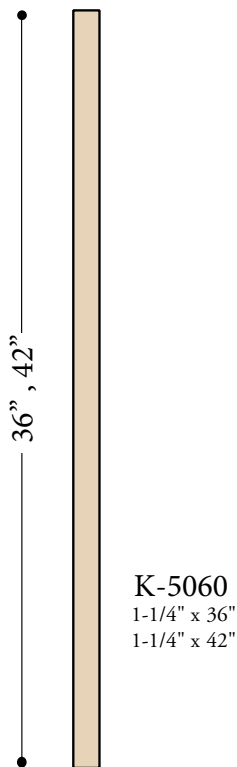
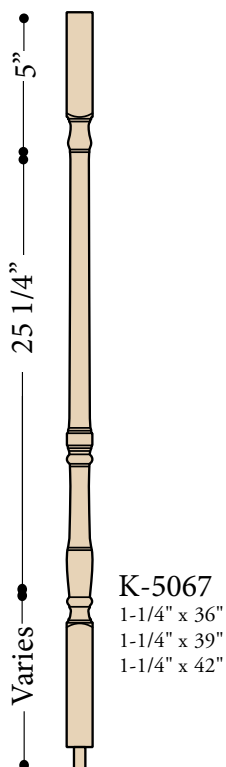
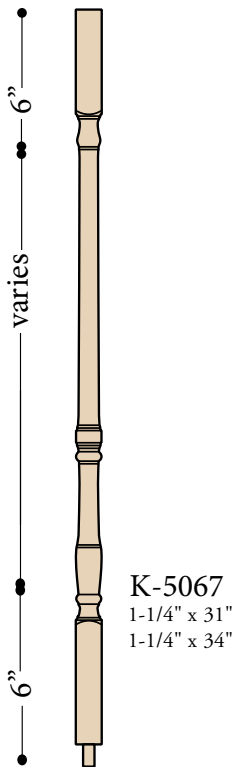
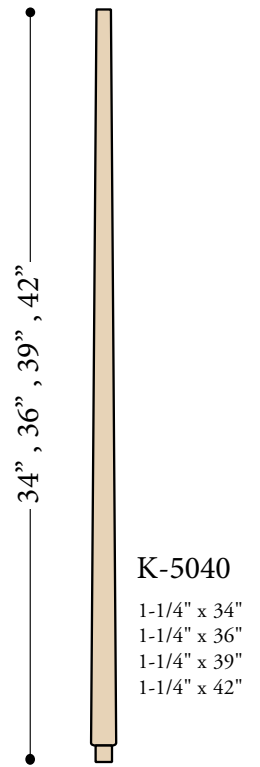
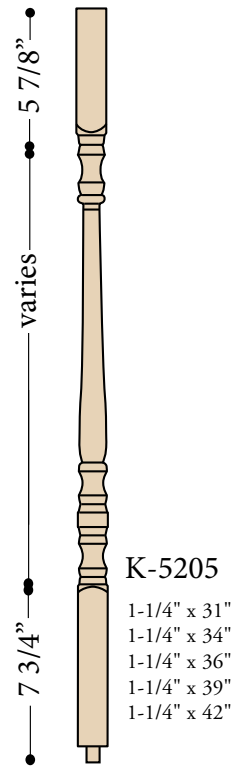
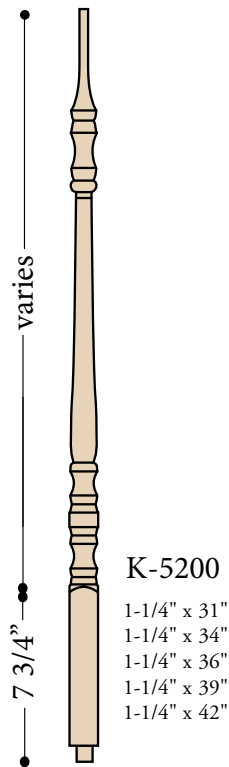
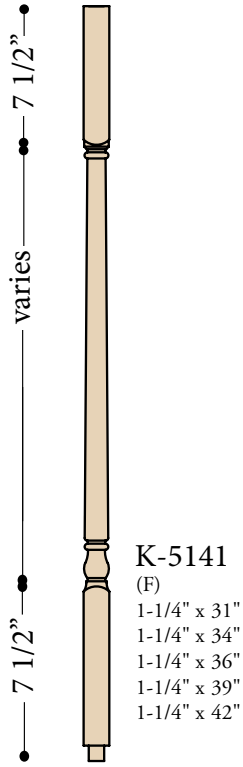
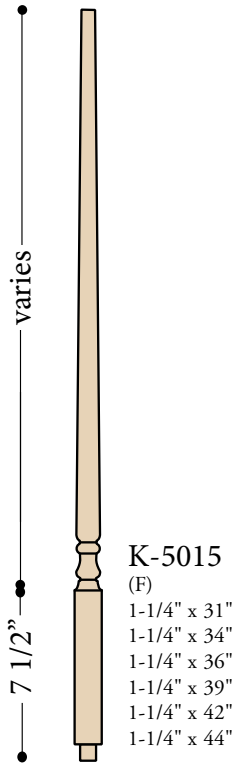

Several balusters and newels are also available in Reeded, Twisted, Fluted & Octagonal.

BALUSTERS

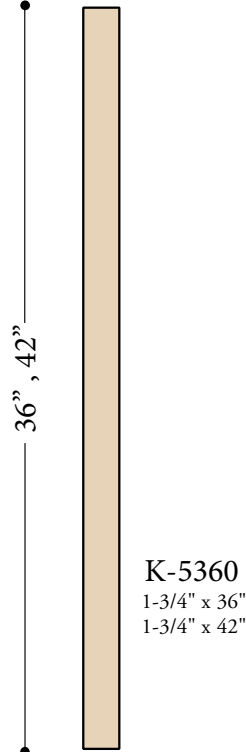
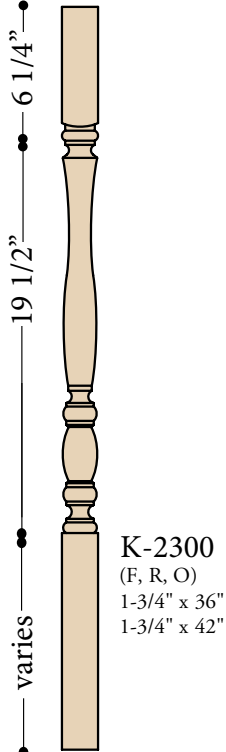
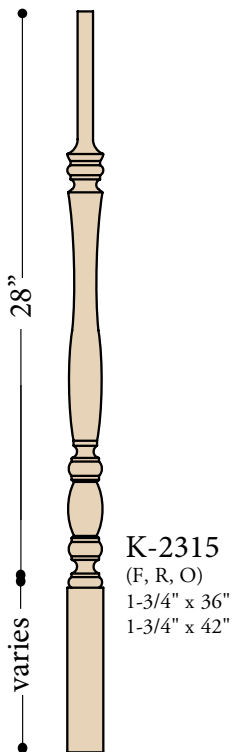
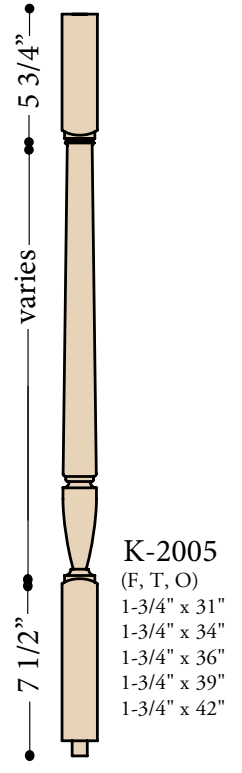
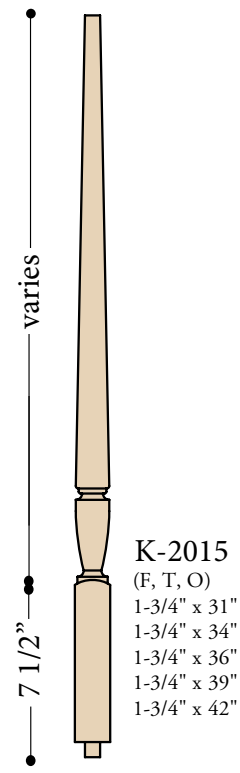
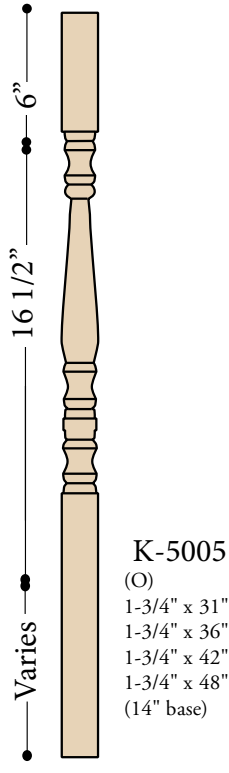
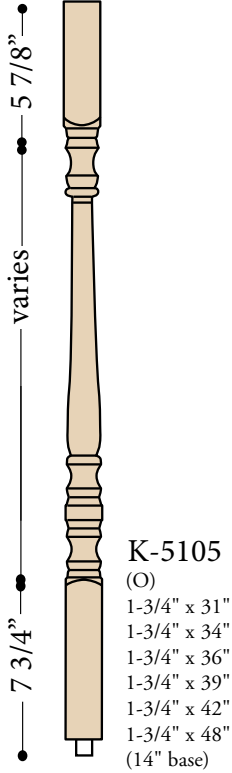
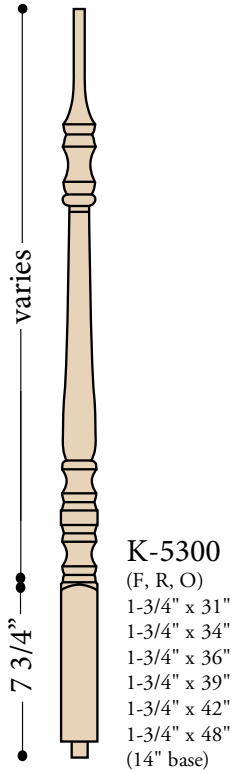

FITTINGS

STARTING FITTINGS FOR K-6010 & K-6210 RAIL PROFILES

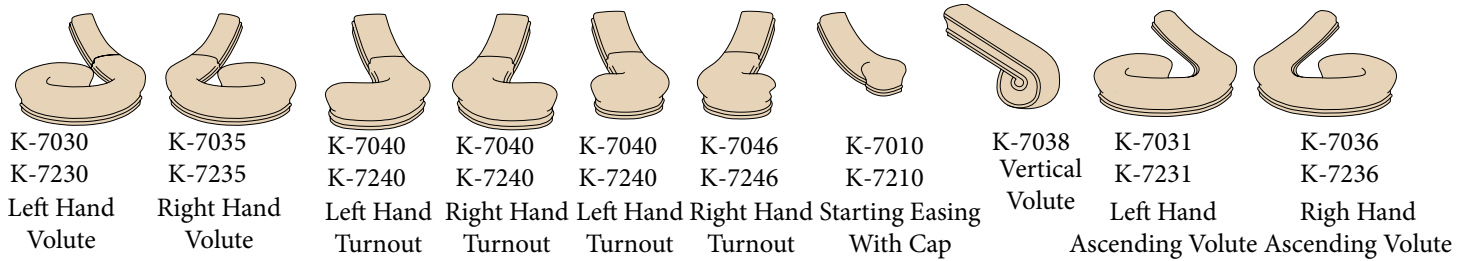

TRANSITION FITTINGS FOR K-6010 & K-6210 RAIL PROFILES

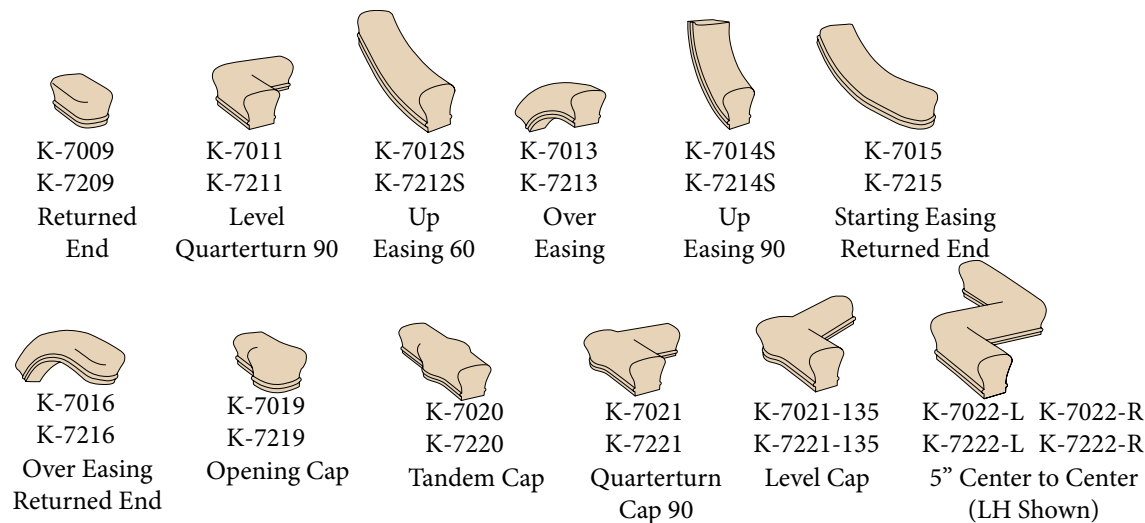

GOOSENECK FITTINGS FOR K-6010 & K-6210 RAIL PROFILES

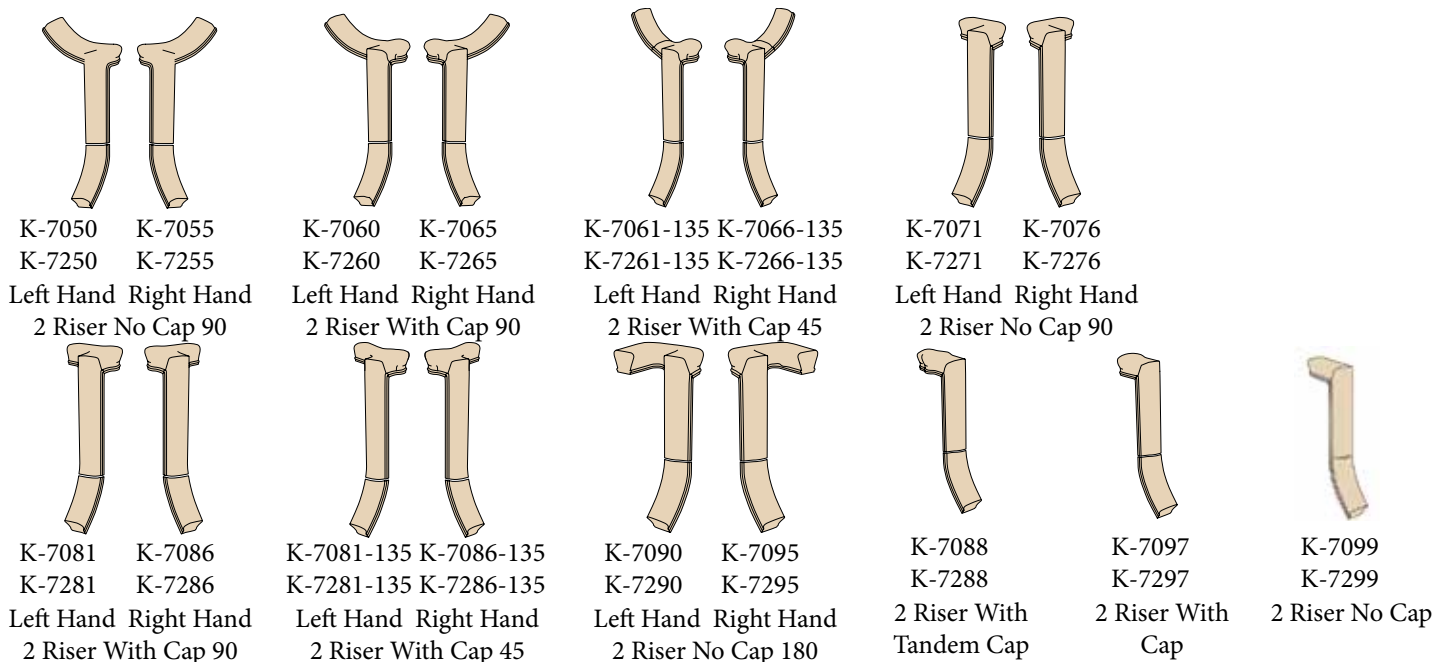

FITTINGS

STARTING FITTINGS FOR K-6010 & K-6210 RAIL PROFILES

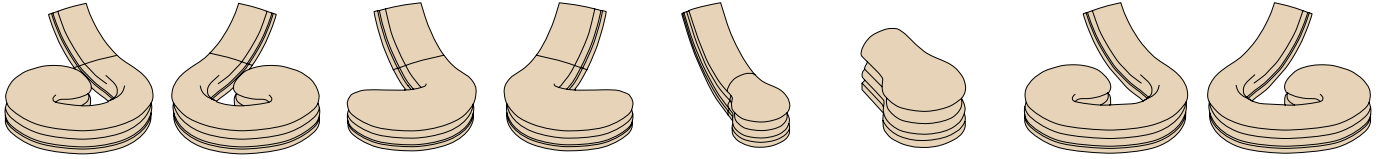

K-7530	K-7535	K-7540	K-7545	K-7510	K-7519	K-7531	K-7536
K-7730	K-7735	K-7740	K-7745	K-7710	K-7719	K-7731	K-7736
K-7930	K-7935	K-7940	K-7945	K-7910	K-7919	K-7931	K-7936
Left Hand	Right Hand	Left Hand	Right Hand	Starting Easing	Opening Cap	Left Hand	Right Hand
Volute	Volute	Turnout	Turnout	with Newel Cap		Ascending Volute	Ascending Volute

TRANSITION FITTINGS FOR K-6010 & K-6210 RAIL PROFILES

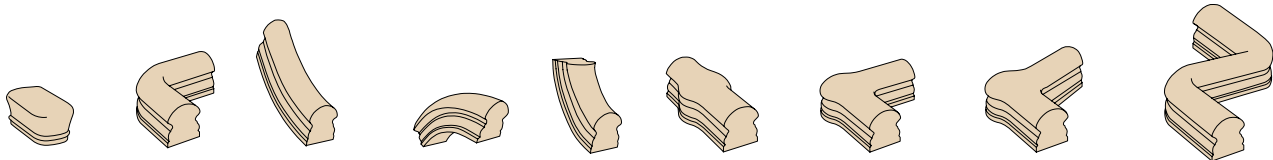

K-7509	K-7511	K-7512S	K-7513	K-7514S	K-7520	K-7521	K-7521-135	K-7522-L	K-7522-R
K-7709	K-7711	K-7712S	K-7713	K-7714S	K-7720	K-7721	K-7721-135	K-7722-L	K-7722-R
K-7909	K-7911	K-7912S	K-7913	K-7914S	K-7920	K-7921	K-7921-135	K-7922-L	K-7922-R
Returned	Level	Up Easing	Over	Up	Tandem	Quarterturn	Level Cap	5" Center to Center	
End	Quarterturn 90		Easing	Easing 90	Cap	Cap 90		(LH Shown)	

GOOSENECK FITTINGS FOR K-6010 & K-6210 RAIL PROFILES

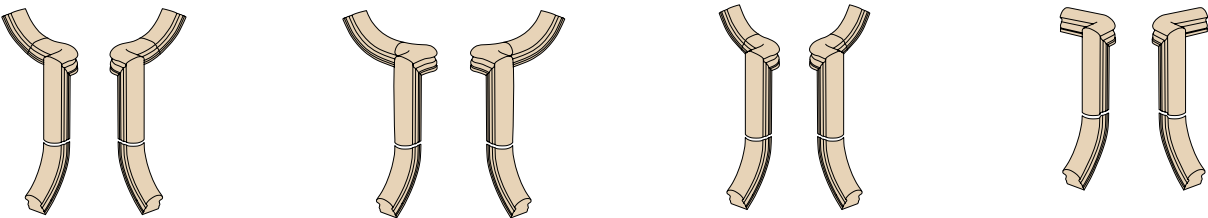

K-7550	K-7555	K-7560	K-7565	K-7560-135	K-7565-135	K-7571	K-7576
K-7750	K-7755	K-7760	K-7765	K-7760-135	K-7765-135	K-7771	K-7776
K-7950	K-7955	K-7960	K-7965	K-7960-135	K-7965-135	K-7971	K-7976
Left Hand	Right Hand	Left Hand	Right Hand	Left Hand	Right Hand	Left Hand	Right Hand
2 Riser No Cap 90		2 Riser No Cap 90		2 Riser No Cap 45		2 Riser No Cap 90	

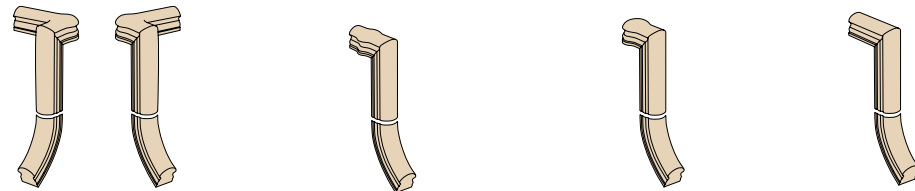

K-7581	K-7586	K-7588	K-7597	K-7599
K-7781	K-7786	K-7788	K-7797	K-7799
K-7981	K-7986	K-7988	K-7997	K-7999
Left Hand	Right Hand	2 Riser Tandem	2 Riser With	2 Riser No Cap
2 Riser No Cap 90		Cap	Cap	

TREADS, RISERS, & ACCESSORIES

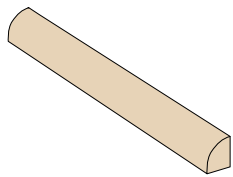

Shoe Mould
1624-A
1/2" x 3/4"

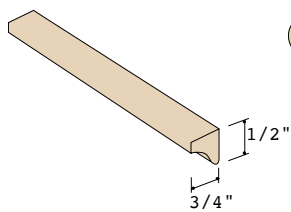

Cove Mould
1624-C
1/2" x 3/4"

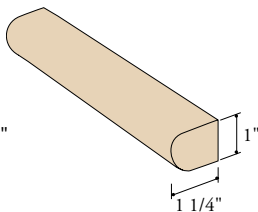

Nosing
K-8080
1-1/4" x 1"

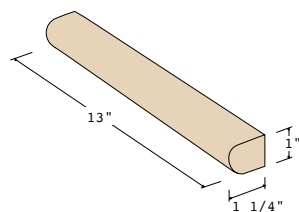

13" Return Nosing
K-8080-13
1-1/4" x 1"

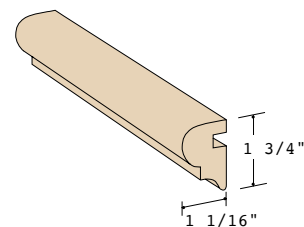

Nosing and Cove
K-8081
1-1/16" x 1-3/4"

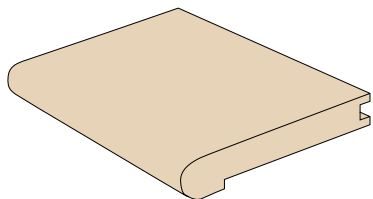

5-1/4" Landing Tread
32168-34-LTG for 3/4" floor
32168-12-LTG for 1/2" floor

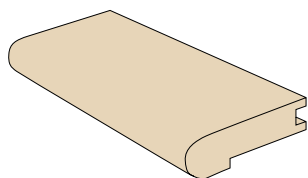

3-1/2" Landing Tread
32112-34-LTG
for 3/4" floor

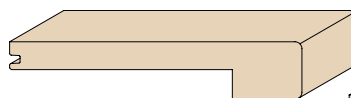

5-1/4" Landing Tread
32168-12-2RE18-LTG
for 1/2" floor

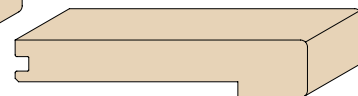

5-1/4" Landing Tread
32168-34-2RE18-LTG
for 3/4" floor

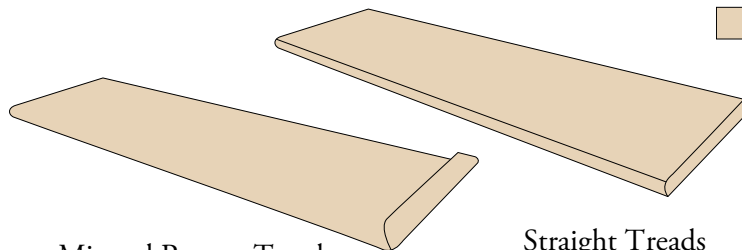

Mitered Return Treads
Available with Single or
Double Returned Ends
(RH Shown)

Straight Treads

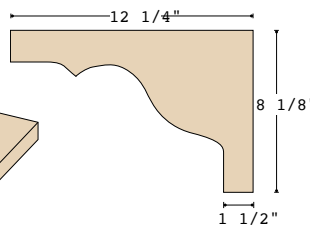

Tread Bracket
K-8028
1/4" thick

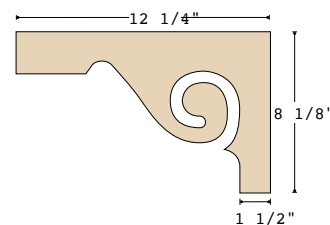

Tread Bracket
K-8029
1/4" thick

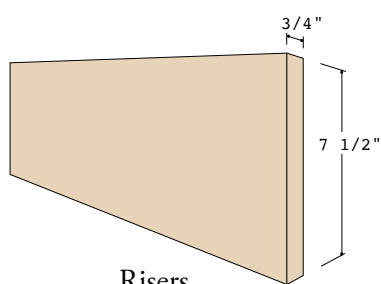

Risers

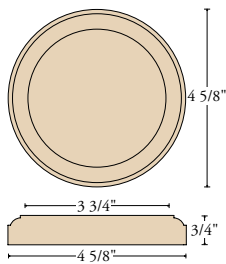

Rosette
K-7317

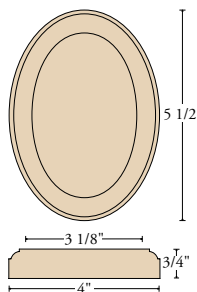

Rosette
K-7337

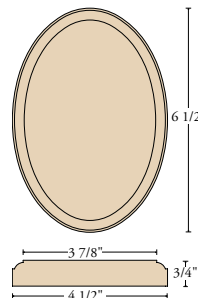

Rosette
K-7337-L

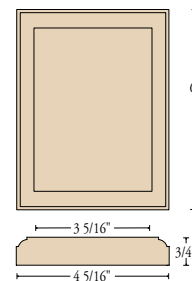

Rosette
K-7318

11-1/4" SKIRTBOARDS

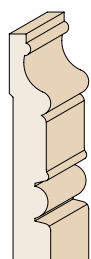

22360-E-B

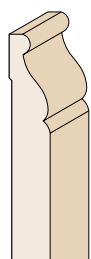

22360-CB

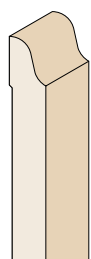

18360-OG-B



24360-S4S

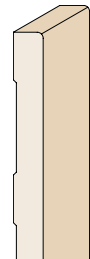

20360-1R18-B

TREADS, RISERS & ACCESSORIES / STARTING STEPS

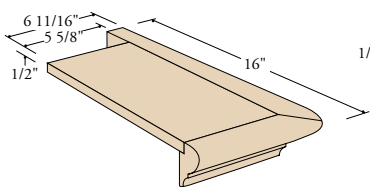

Tread Cap w/Mitered Return
K-8071
 5-5/8" x 11-1/2"
 Specify LH or RH
 (RH Shown)

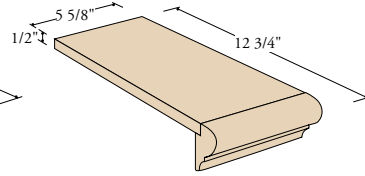

Tread Cap
K-8072
 5-5/8" x 11-1/2"

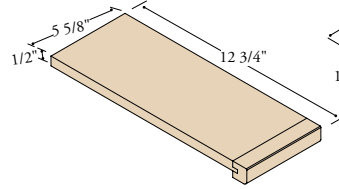

K-8072-2RE18
 5-5/8" x 11-1/2"

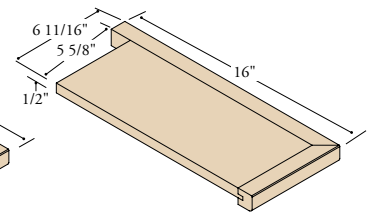

K-8071-2RE18
 5-5/8" x 11-1/2"
 Specify LH or RH
 (RH Shown)

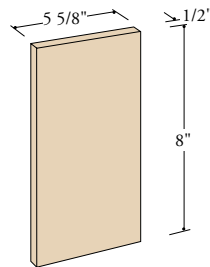

Riser Cap
K-8076
 4-3/4" x 8"

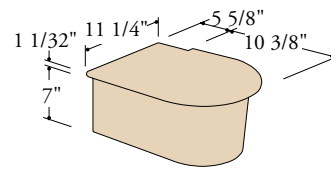

Starting End Cap
K-8011
 Specify LH or RH
 (RH Shown)

STARTING STEPS

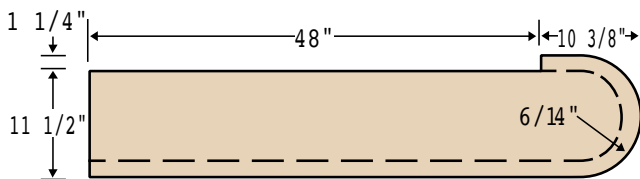

K-8010

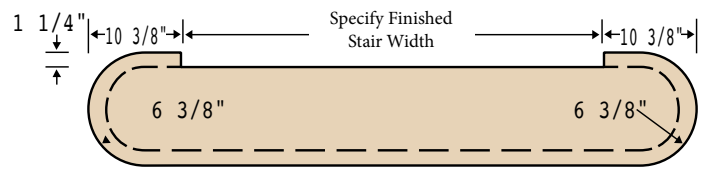

K-8015

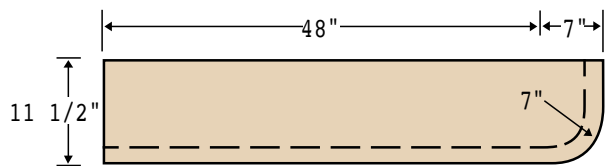

K-8040

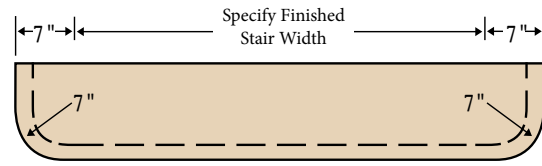

K-8060

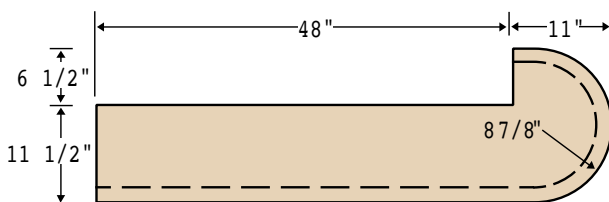

K-8030

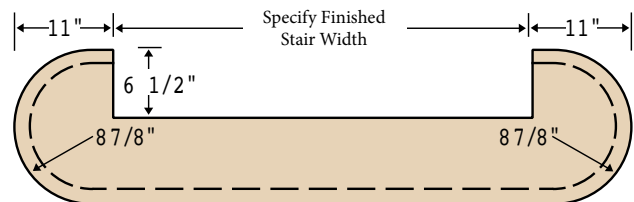

K-8050

All starting steps are shipped complete including the tread, riser, cove and shoe moulding.
 Custom sized/shaped starting steps are available on a special order basis.

HARDWARE

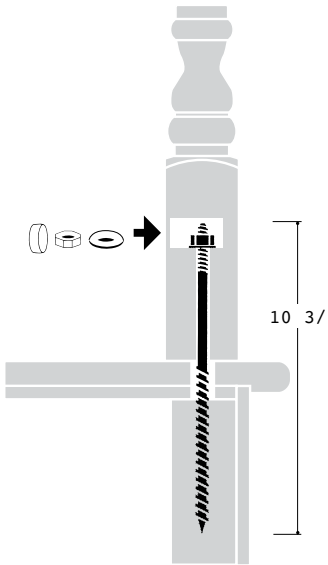

K-3008
Sure Tite
Newel Fastening System
 Includes: Lag Bolt, Washer,
 Nut & 1-1/2" Plugs

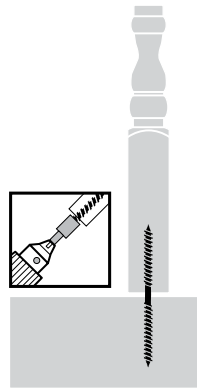

K-201B
1/4" Baluster Fastener
Drill Driver

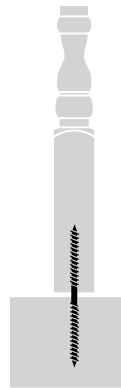

K-3202
 20-pack
1/4" x 2" Baluster Fasteners

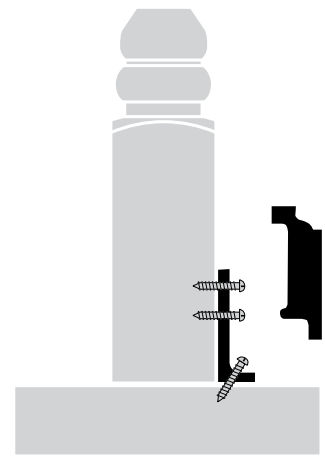

K-3505-30 - 3"
K-3505-35 - 3-1/2"
L-Bracket Post Fastener

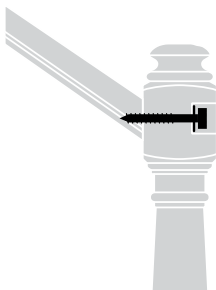

K-3301
Rail & Post Fastener
 Includes: Fastener, Washer,
 Nut & 1" Plugs

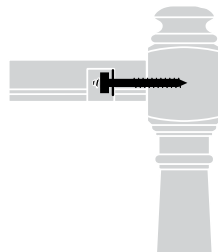

K-3302
Rail Bolt Fastener
 Includes: Fastener, Washer,
 Nut & Plugs

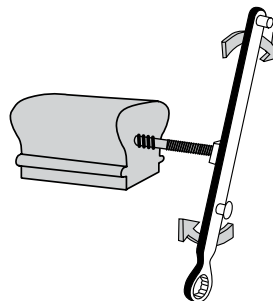

K-3901
Rail Bolt Wrench

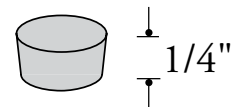

K-3000
Flush Rail Plug
 1" Diameter

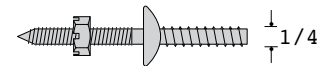

K-3001
3-1/2" Rail Bolt

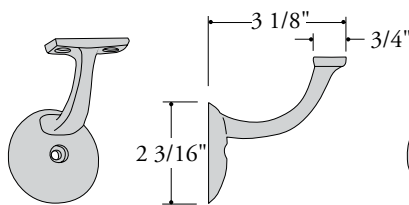

K-3601
Heavy Duty Wall
Rail Bracket
 (Available in Antique Brass,
 Bright Brass and Nickel Finish)

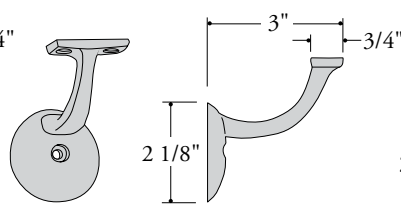

K-9802
Heavy Duty Wall
Rail Bracket
 (Available in Matte Black,
 Oil Rubbed Bronze, Satin Black
 and Silver Vein Finish)

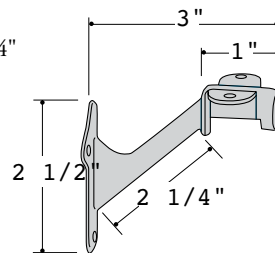

K-3002
Wall Rail Bracket
 (Brass Finish)

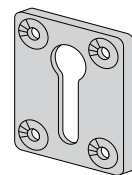

K-3283
Key Lock
 2" x 2-5/8" x 3/8"

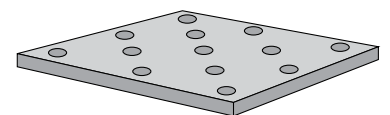

K-3501
4-5/8" Rail Plate
 Includes: Plate and
 13-3" Fastening Screws

STAIR SYSTEM

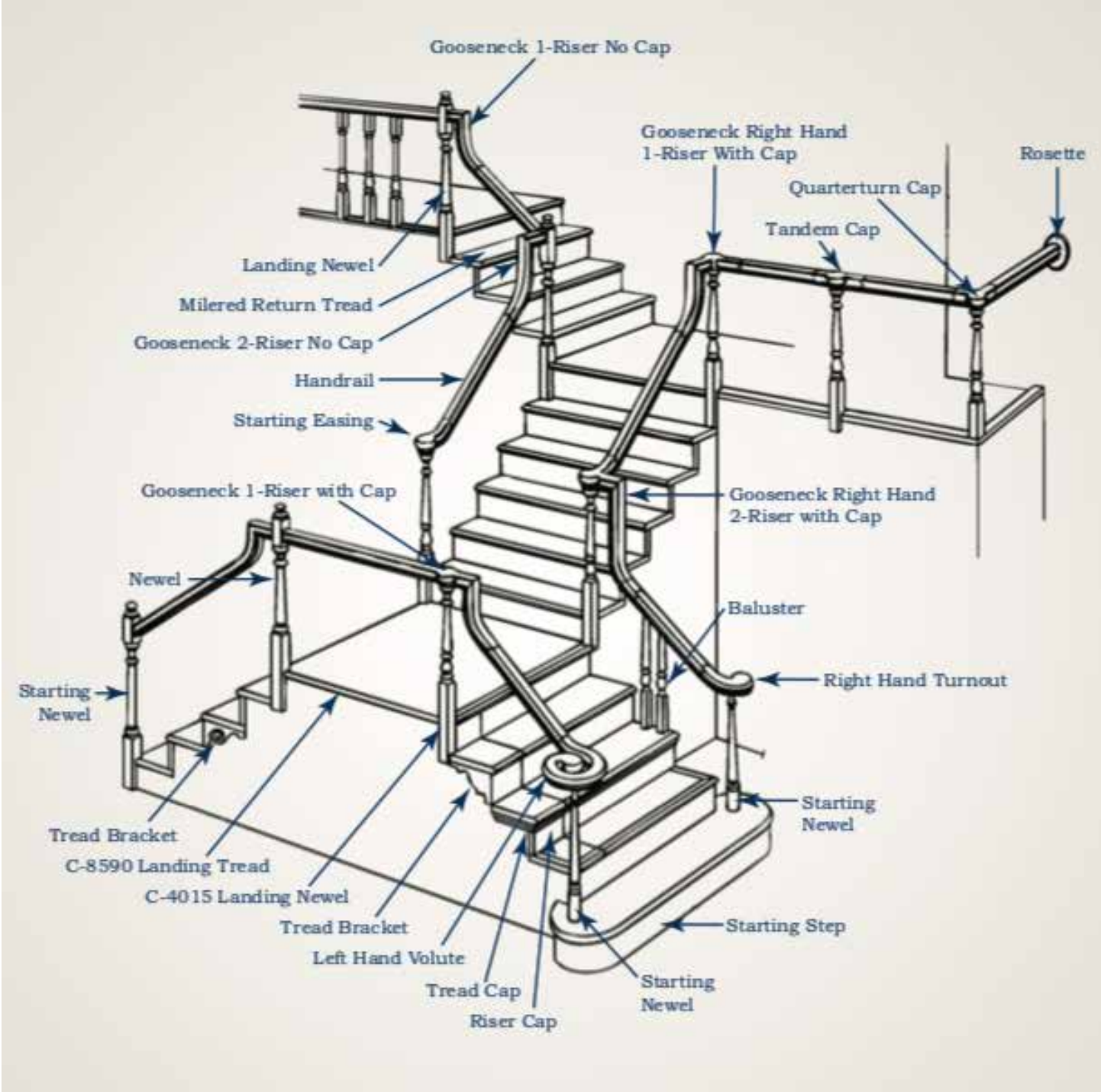

Additional Products and Services

Interior Wood Products is committed to being the industry leader in service, product offering, and value. See below for our specialty items and services.

Mill Services

Custom Knife Grinding	Ripping
CNC Machining	Planing
Interior Door Pre-Hanging	Sanding
Exterior Door Pre-Hanging	Glue Up
Finishing	Fluting



Custom Wood Products

Treads	Wine Cellar Components
Starting Steps	Veneers
Wood Transitions	Plywoods
Cabinet Doors	Wood Columns
Corbels	Wood Components
Table Tops	Decorative Panels
Mantels	Library Paneling
Drawer Boxes	Closet Shelving
Wood Shutters	Rough Lumber
Wood Flooring	



Specialty Hardware and Accessories

Decorative Hardware	Cabinet Hardware
Screws and Fasteners	Hinges
Opening Systems	Drawer Slides
Closet Solutions	Adhesives and Fillers
Sliding Doors and Lateral Opening Systems	Builders Hardware
Bath Hardware	Commercial Hardware
Metal Door Frames	



Logistics

Same-Day / Next-Day Job Site Delivery	Extra Material Pick Up / Return
Local Delivery	Regional / National Shipping
Import / Export of Commodity Products	

Accounting

Individualized Account Managers	Same-Day Invoicing
Account Pricing	Payment Terms
Streamlined Billing	Monthly Account Statements
Volume Discounts and Rebates	Early Pay Discounts
Referral Bonuses	

7795 A Corporate Blvd., Plain City, OH 43064