

The image shows a bright interior space with a large, multi-paned window on the left. To the right, a dark-colored barn door with a prominent 'X' design is partially open, revealing a white door underneath. The walls are finished with light-colored horizontal shiplap. A white chair is visible in the lower-left corner, and a patterned rug is on the floor.

ARCHITECTURAL MILLWORK

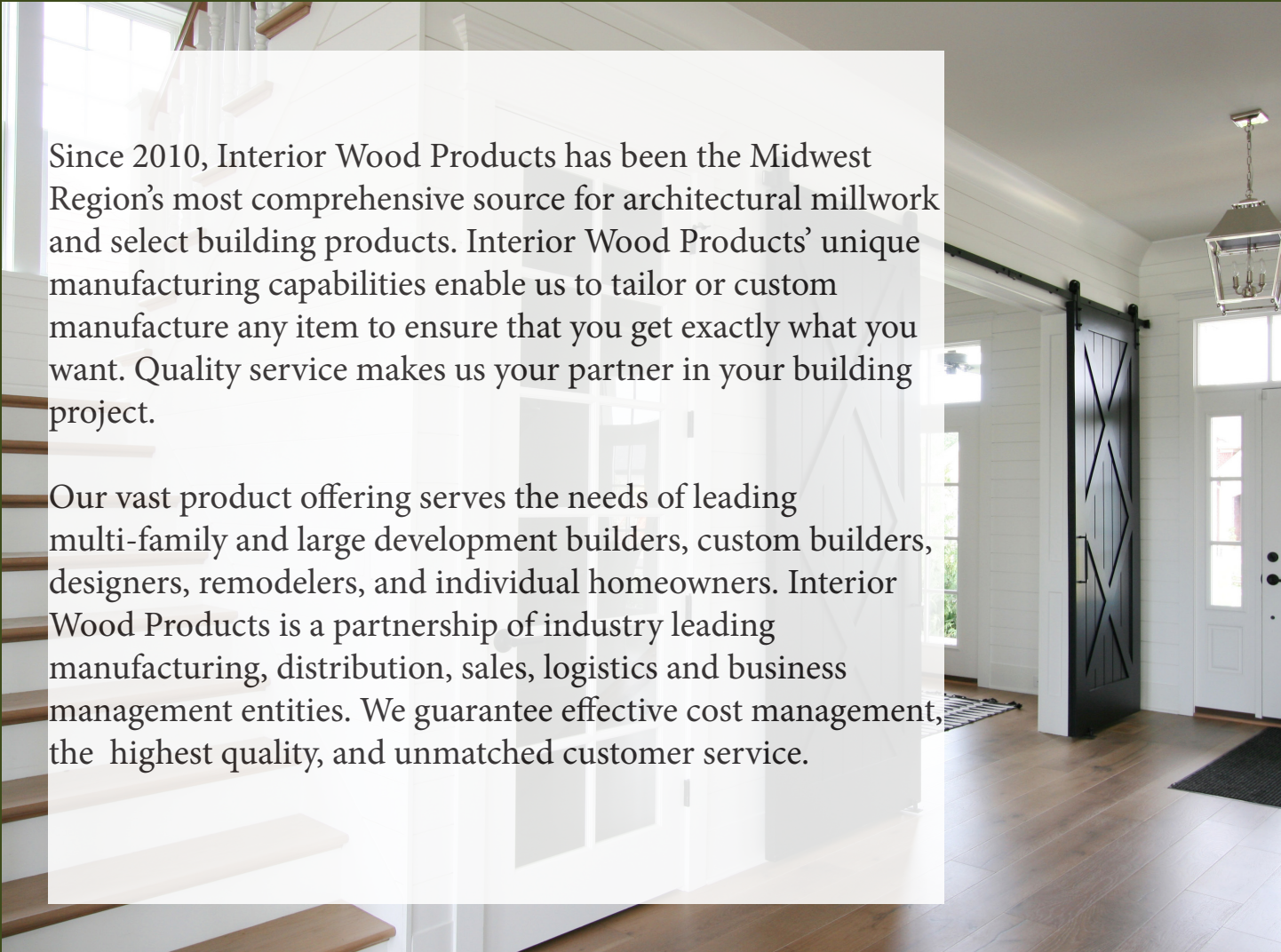

DOORS - MOULDINGS - STAIR PARTS
HARDWARE



Since 2010, Interior Wood Products has been the Midwest Region's most comprehensive source for architectural millwork and select building products. Interior Wood Products' unique manufacturing capabilities enable us to tailor or custom manufacture any item to ensure that you get exactly what you want. Quality service makes us your partner in your building project.

Our vast product offering serves the needs of leading multi-family and large development builders, custom builders, designers, remodelers, and individual homeowners. Interior Wood Products is a partnership of industry leading manufacturing, distribution, sales, logistics and business management entities. We guarantee effective cost management, the highest quality, and unmatched customer service.

TABLE OF CONTENTS

Casings	3 - 13
Backbands	14
Base Caps & Bases	16 - 27
Crowns	28 - 40
Dentils & Mantel Mould	42
Chair Rails & Stops	43
Trim & Mulls	44 - 45
Panel Moulds	46
Stools	47
Bar Rails	48
Primed MDF Tongue & Groove	49-51
S4S	52- 53

CASINGS



2488-2R-CA $\frac{3}{4}$ " x $2\frac{3}{4}$ "

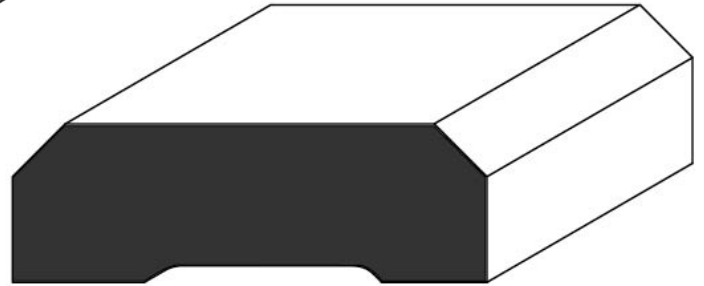

2472-C-CA $\frac{3}{4}$ " x $2\frac{1}{4}$ "

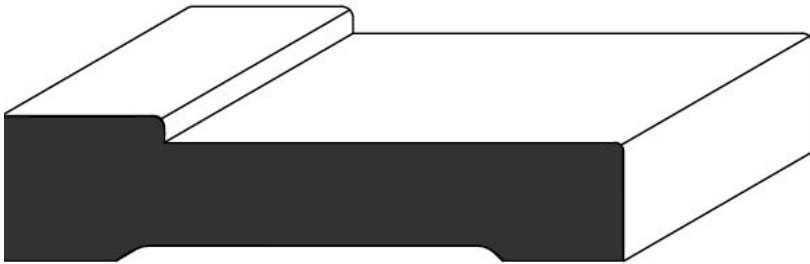

24104-DD1-CA $\frac{3}{4}$ " x $3\frac{1}{3}$ "



24104-C-CA $\frac{3}{4}$ " x $3\frac{1}{4}$ "



24112-R-CA $\frac{3}{4}$ " x $3\frac{1}{2}$ "



24104-R-CA $\frac{3}{4}$ " x $3\frac{1}{4}$ "

CASINGS

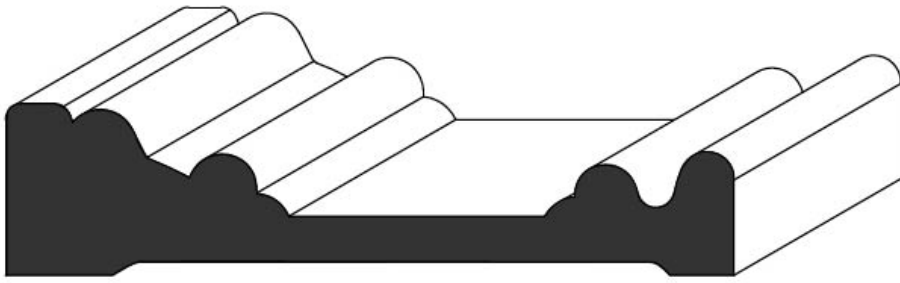

32136-CA 1" x 4 1/2"

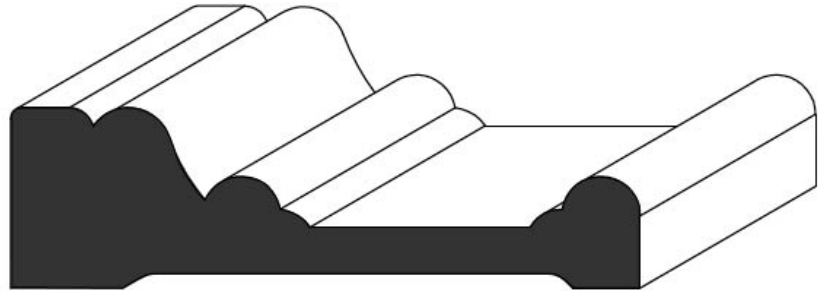

32112-H-CA 1" x 3 1/2"

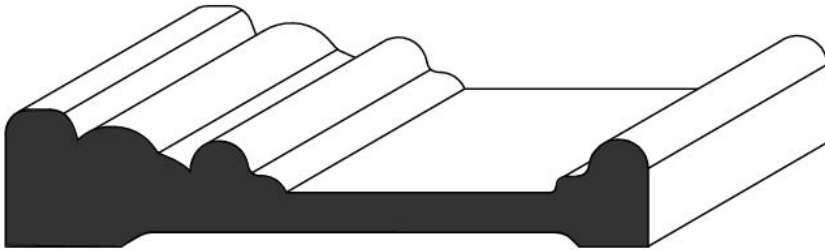

24112-CA 3/4" x 3 1/2"

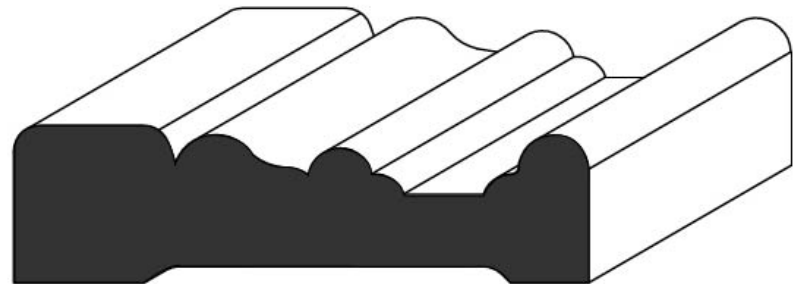

2488-CA 3/4" x 2 3/4"

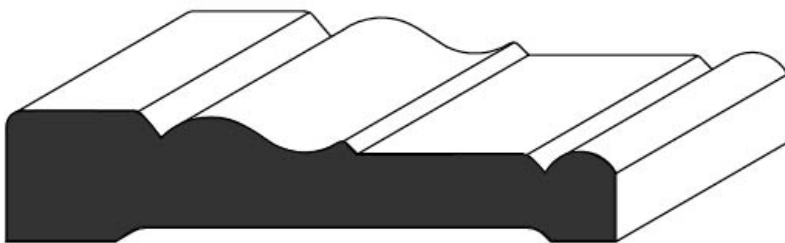

24112-C-CA 3/4" x 3 1/2"

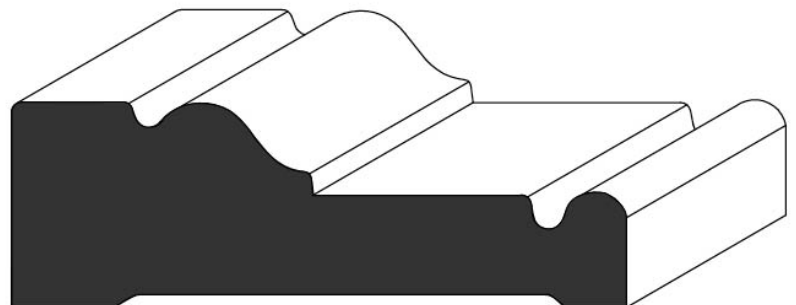

40120-CA 1 1/4" x 3 3/4"

CASINGS

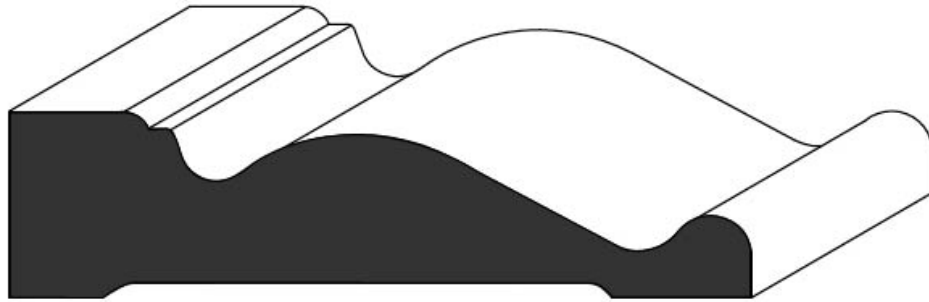

32128-G-CA 1" x 4"

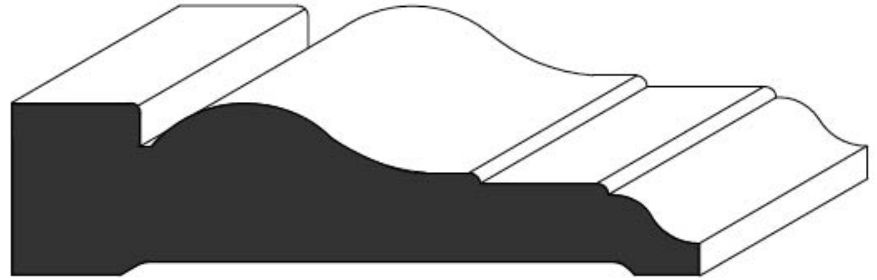

32128-H-CA 1" x 4"

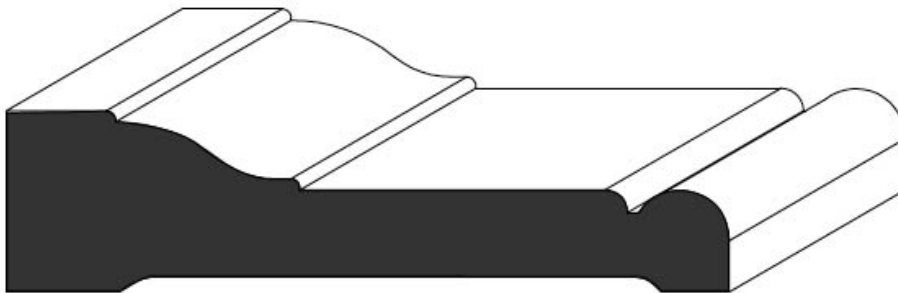

32128-I-CA 1" x 4"

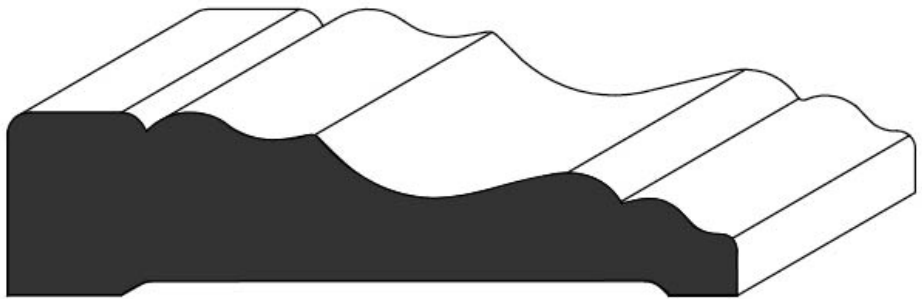

32128-J-CA 1" x 4"

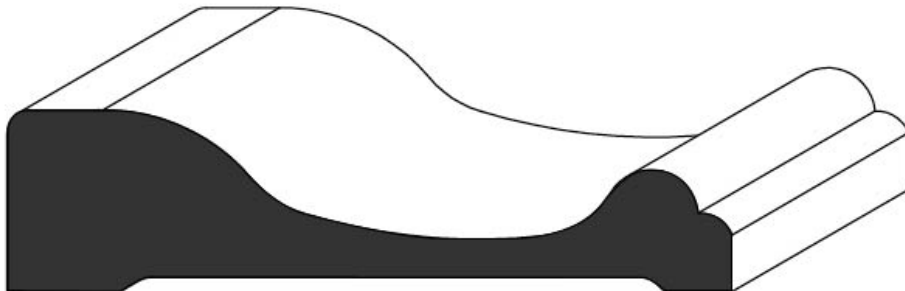

32128-K-CA 1" x 4"

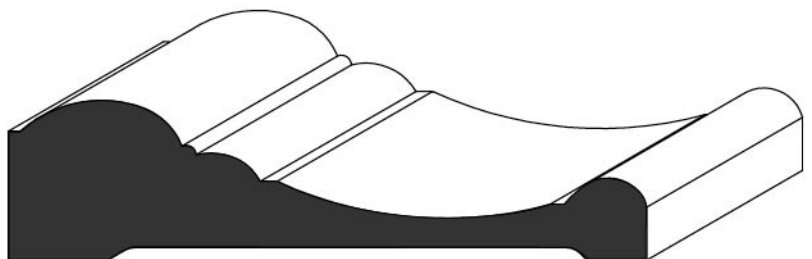

32128-L-CA 1" x 4"

CASINGS

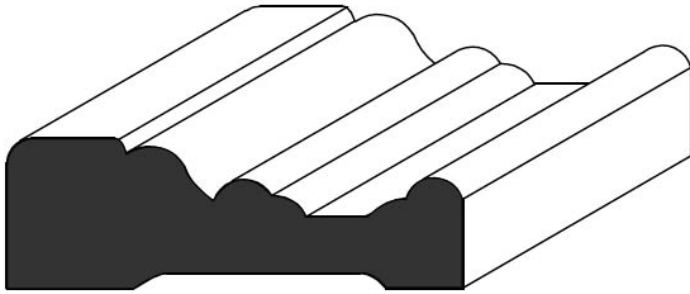

2472-MW-CA $\frac{3}{4}$ " x $2\frac{1}{4}$ "

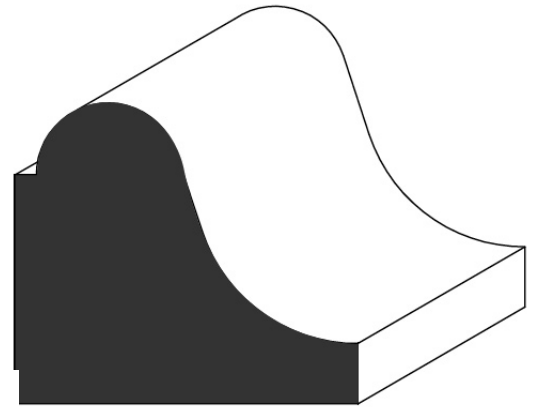

5664-IT2-CA $1\frac{3}{4}$ " x 2"

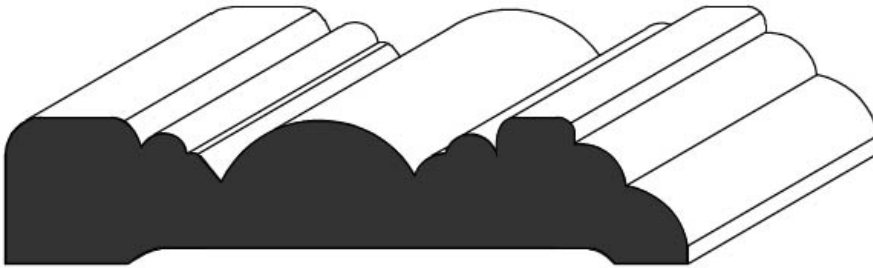

24112-B-CA $\frac{3}{4}$ " x $3\frac{1}{2}$ "

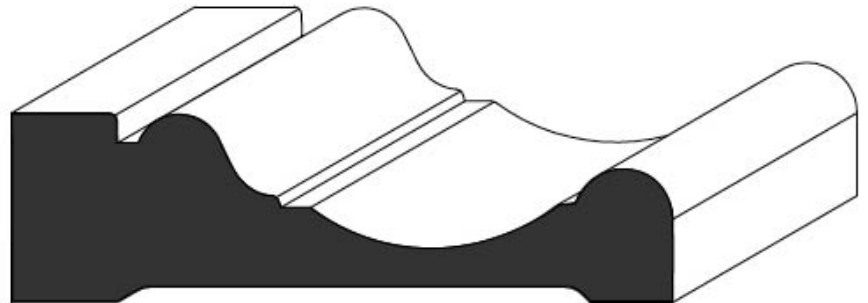

32112-IT2-CA 1" x $3\frac{1}{2}$ "

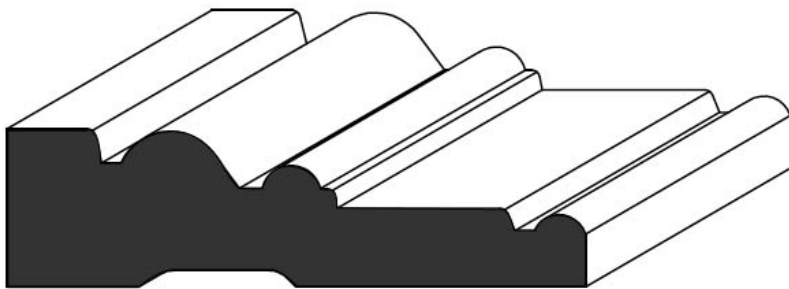

2488-E-CA $\frac{3}{4}$ " x $2\frac{3}{4}$ "



2488-B-CA $\frac{3}{4}$ " x $2\frac{3}{4}$ "

CASINGS

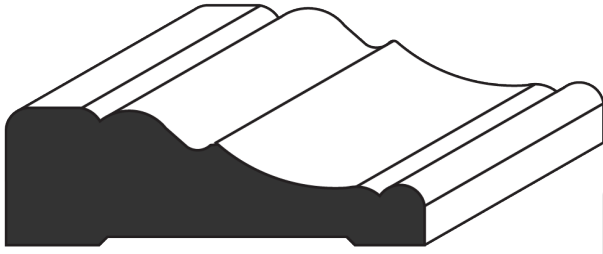

2472-B-CA $\frac{3}{4}$ " x $2\frac{1}{4}$ "

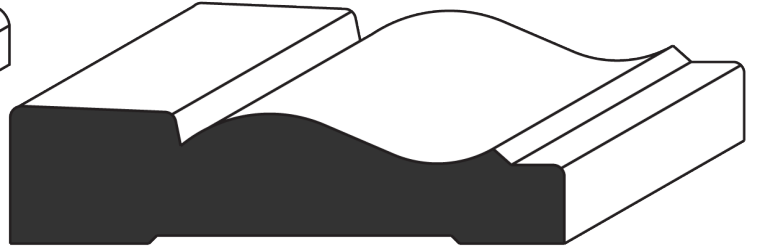

2496-Q-CA $\frac{3}{4}$ " x 3"



24112-E-CA $\frac{3}{4}$ " x $3\frac{1}{2}$ "



24136-E-CA $\frac{3}{4}$ " x $4\frac{1}{4}$ "



24112-RD-CA $\frac{3}{4}$ " x $3\frac{1}{2}$ "

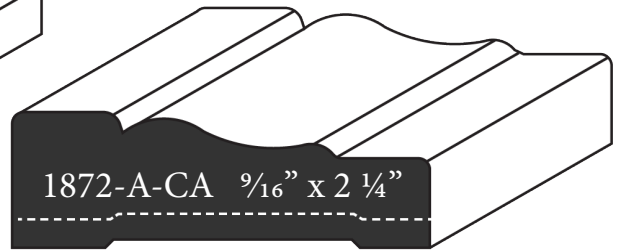

1872-A-CA $\frac{9}{16}$ " x $2\frac{1}{4}$ "

2472-A-CA $\frac{3}{4}$ " x $2\frac{1}{4}$ "

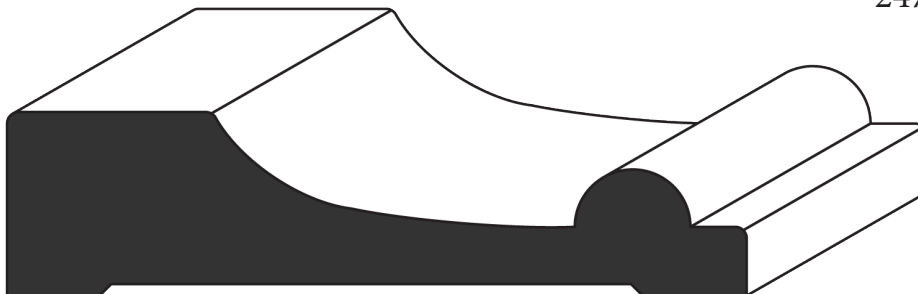

32128-CRB 1" x 4"

CASINGS



RFJ 26112-T-CA $1\frac{3}{16}$ " x $3\frac{1}{2}$ "

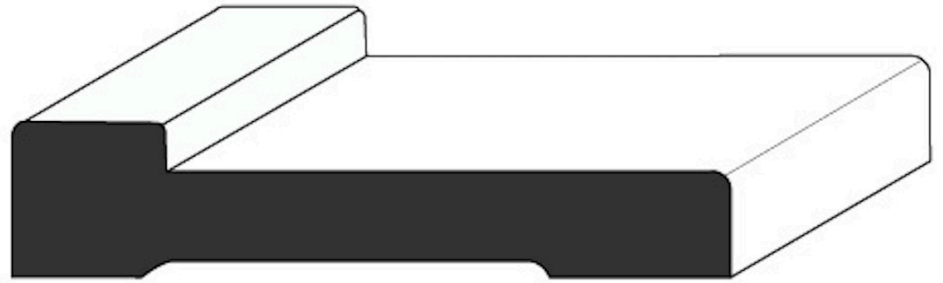

RFJ 24112-EX6-CA $\frac{3}{4}$ " x $3\frac{1}{2}$ "

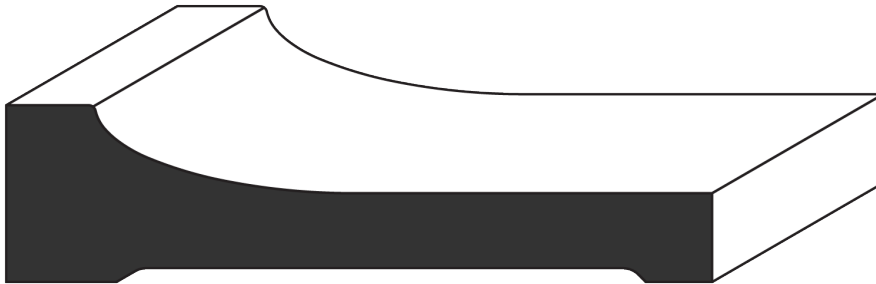

32128-T-CA 1" x 4"

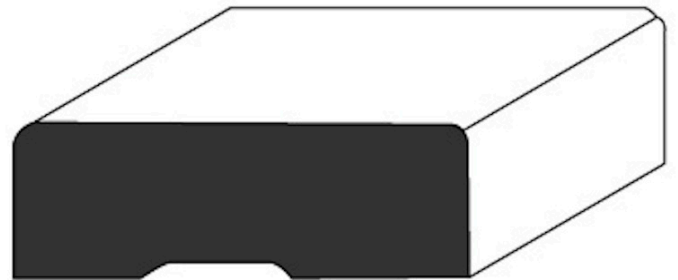

RFJ 2472-2R18-CA $\frac{3}{4}$ " x $2\frac{1}{4}$ "



2496-P-CA $\frac{3}{4}$ " x 3"



24112-P-CA $\frac{3}{4}$ " x $3\frac{1}{2}$ "

CASINGS & PRIMED MDF CASINGS



24112-F-CA $\frac{3}{4}$ " x $3\frac{1}{2}$ "

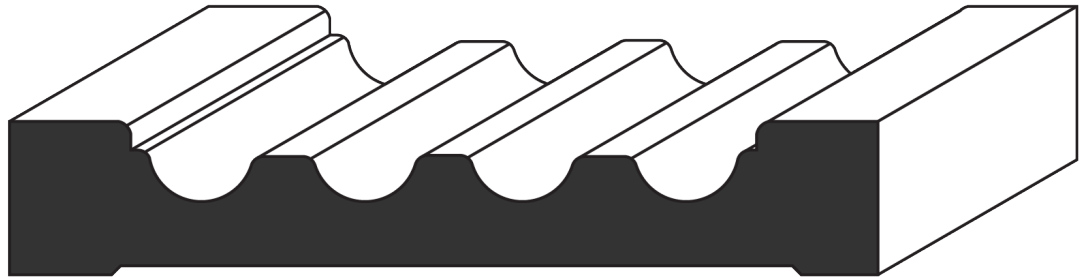

24136-RF-CA $\frac{3}{4}$ " x $4\frac{1}{4}$ "



18M112-P-CA 18mm x $3\frac{1}{2}$ "

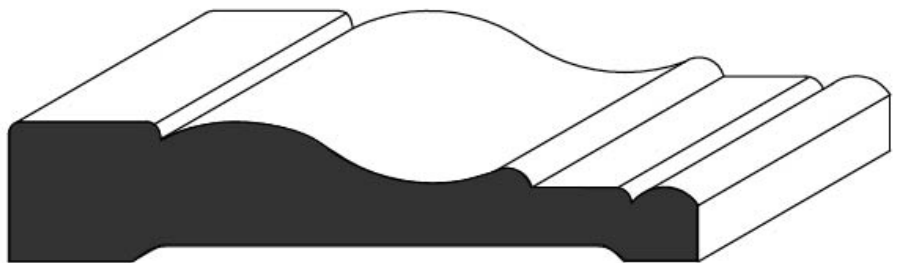

18M112-UL-CA 18mm x $3\frac{1}{2}$ "

PRIMED MDF CASINGS

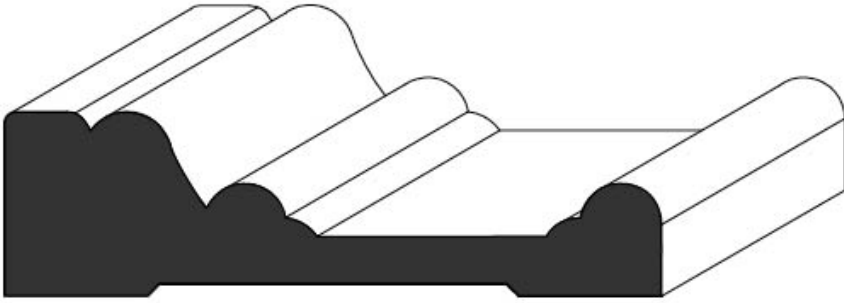

25M112-H-CA 25mm x 3 1/2"

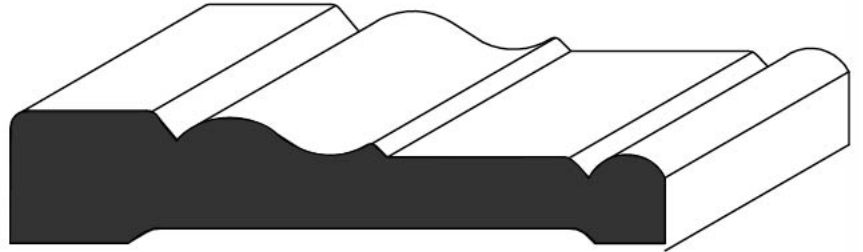

18M112-C-CA 18mm x 3 1/2"

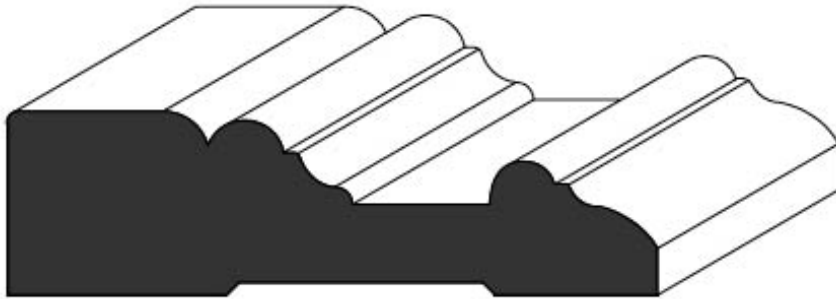

25M112-CA 25mm x 3 1/2"

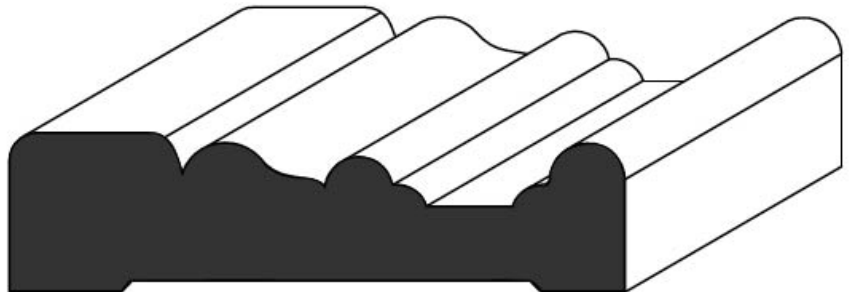

18M88-CA 18mm x 2 3/4"



24112-R-CA 3/4" x 3 1/2"

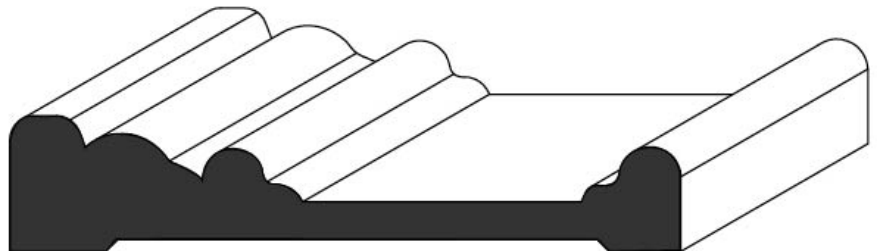

18M112-CA 18mm x 3 1/2"

VINTAGE SERIES CASINGS



E2E 3/4" x 2 1/2"



C-206 1 1/16" x 2 1/2"

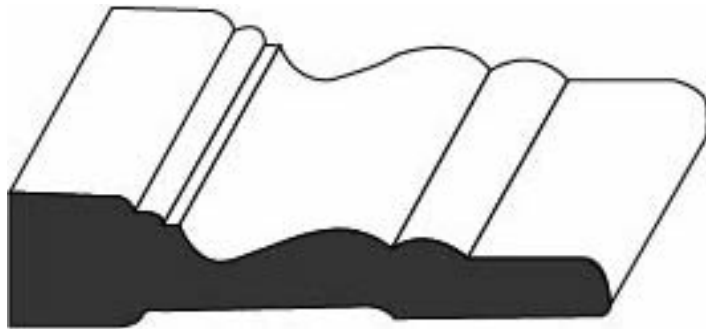

C-400 9/16" x 2 1/2"



C-243 3/4" x 3"

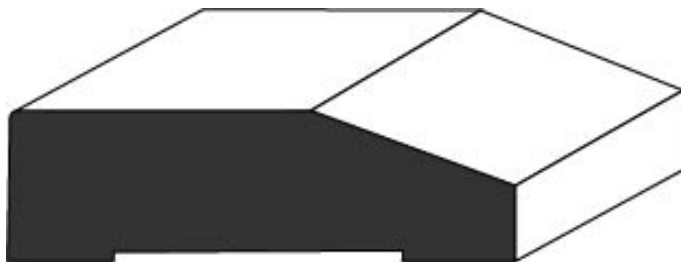

C-242 3/4" x 2 1/2"

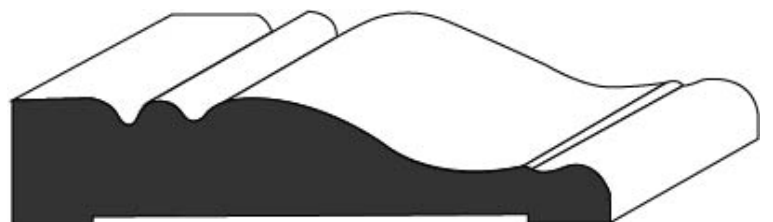

C-216 3/4" x 3 1/2"

VINTAGE SERIES CASINGS



C-207 $\frac{3}{4}$ " x 3"



C-219 $\frac{3}{4}$ " x 2 $\frac{1}{2}$ "



C-233 $\frac{3}{4}$ " x 3 $\frac{1}{2}$ "



C-238 $\frac{3}{4}$ " x 3"



C-244 $\frac{3}{4}$ " x 2 $\frac{1}{2}$ "

*Our Vintage Series profiles may not be in stock. For any profiles that are not in stock, there will be a 2 week lead time.

GESSO PINE CASINGS



21112-2R18-CA $2\frac{1}{32}$ " x $3\frac{1}{2}$ "

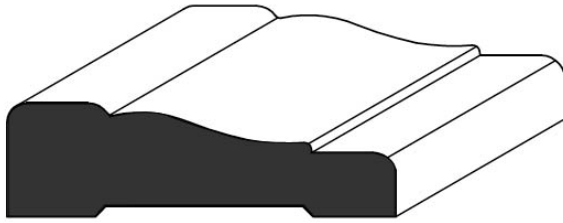

PFP WM356 $1\frac{1}{16}$ " x $2\frac{1}{4}$ " x 14'
PFP WM 356 84 $1\frac{1}{16}$ " x $2\frac{1}{4}$ " x 84"

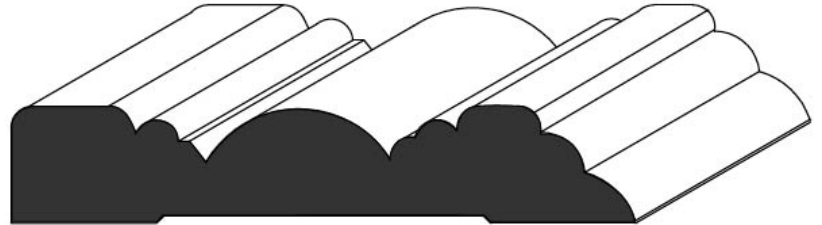

PFP 2212-B-CA $1\frac{1}{16}$ " x $3\frac{1}{2}$ " x 15'

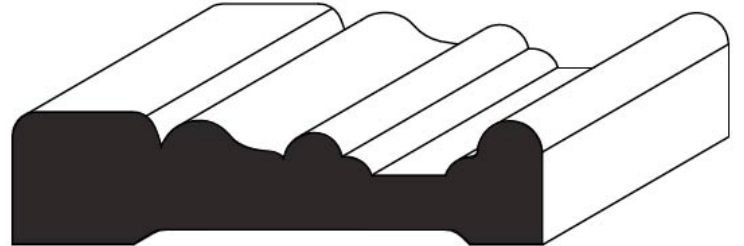

PFP 2288-CA $1\frac{1}{16}$ " x $2\frac{3}{4}$ " x 15'
PFP 2288-CA 86 $1\frac{1}{16}$ " x $2\frac{3}{4}$ " x 86"

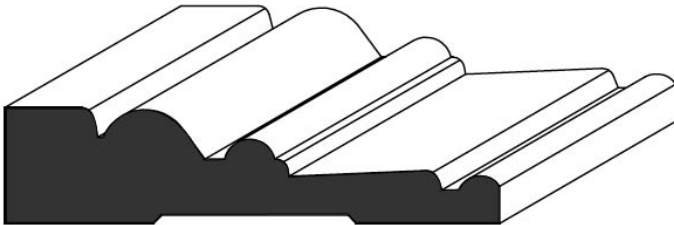

PFP 2288-E2-CA $1\frac{1}{16}$ " x $2\frac{3}{4}$ " x 15'

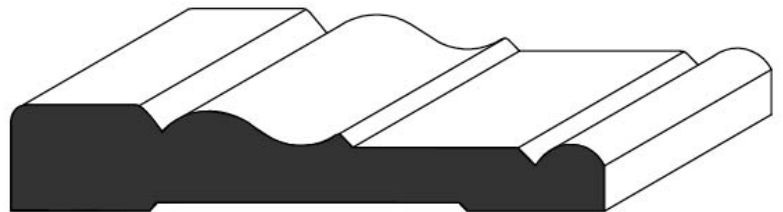

PFP 22112-C2-CA $1\frac{1}{16}$ " x $3\frac{1}{2}$ " x 15'

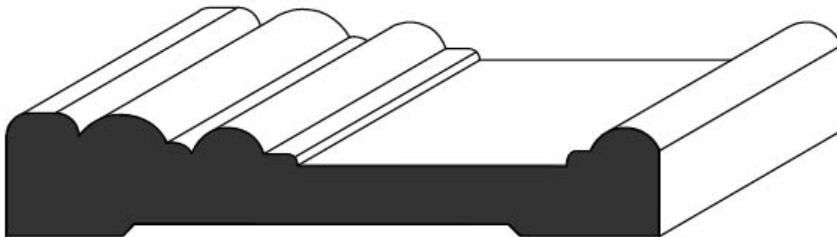

PFP 22112-W-CA $1\frac{1}{16}$ " x $3\frac{1}{2}$ " x 15'

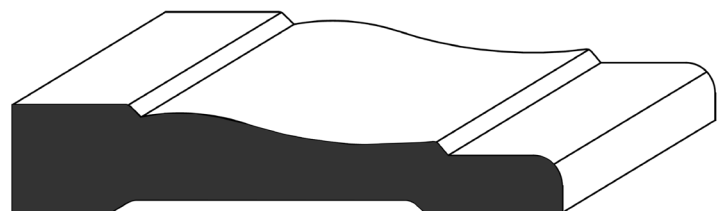

PFP WM444 $2\frac{1}{32}$ " x $3\frac{1}{2}$ "

BACKBANDS

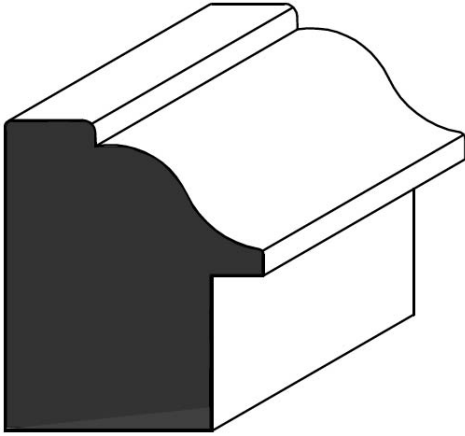

4048-ID-BB 1 1/4" x 1 1/2"
(1/4" x 3/4" rabbet)

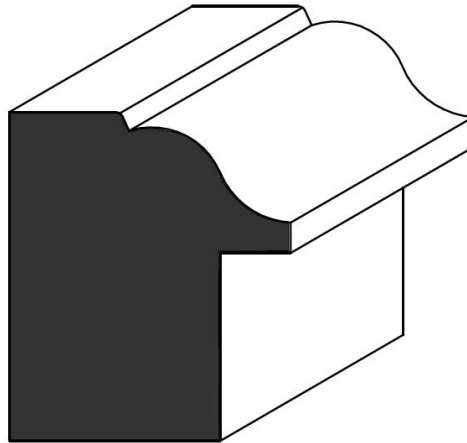

4856-ITC-BB 1 1/2" x 1 3/4"
(3/8" x 1" rabbet)

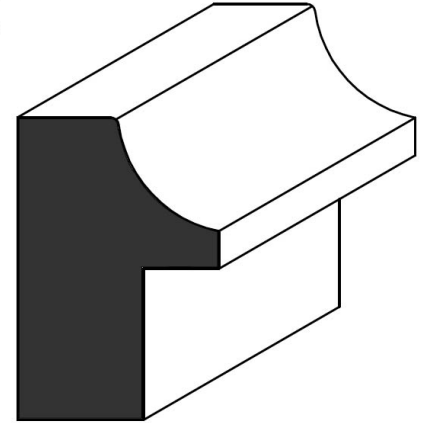

3248-IT-BB 1" x 1 1/2"
(3/8" x 3/4" rabbet)

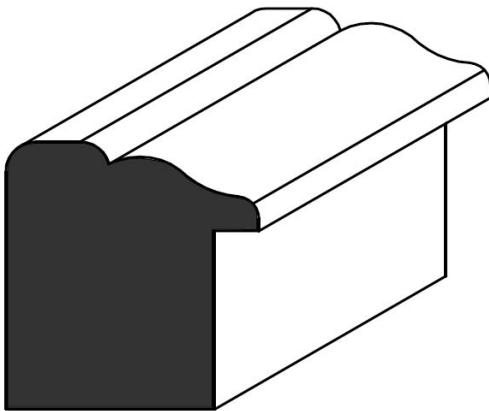

3436-BB 1 1/16" x 1 1/8"
(3/16" x 3/4" rabbet)

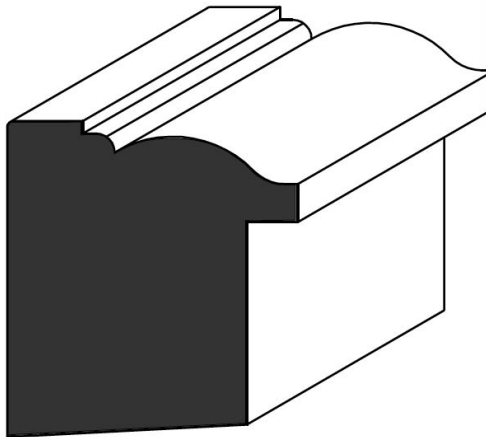

4650-A-BB 1 7/16" x 1 9/16"
(1/4" x 1 1/16" rabbet)
Adjustable to fit 1" or 1 1/16" casing

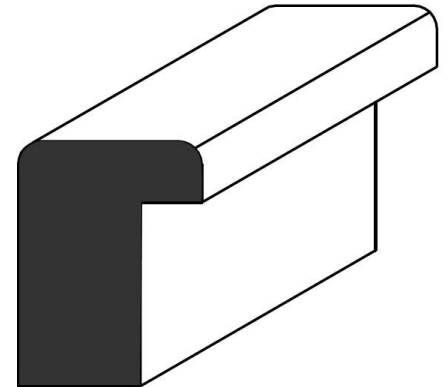

2432-EG-BB 3/4" x 1"
(1/4" x 3/4" rabbet)

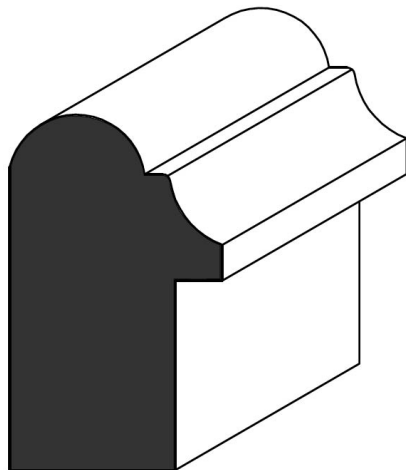

3660-BB 1 1/8" x 1 7/8"
(1/4" x 1" rabbet)

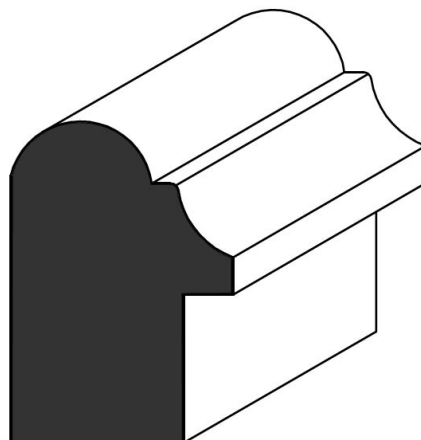

3652-BB 1 1/8" x 1 5/8"
(1/4" x 3/4" rabbet)

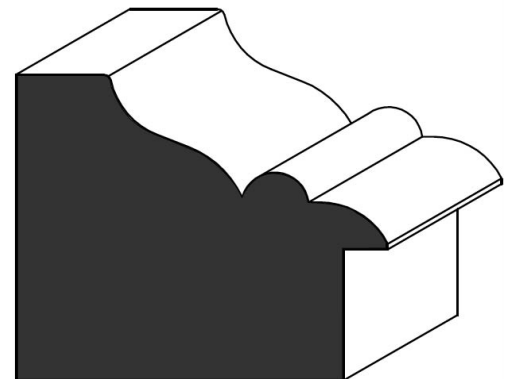

5668-BB 1 3/4" x 2 1/8"
(1/4" x 3/4" rabbet)

PEDIMENT HEAD DESIGN IDEAS

Adding a pediment head is a simple way to dramatically transform any architectural door or window opening.

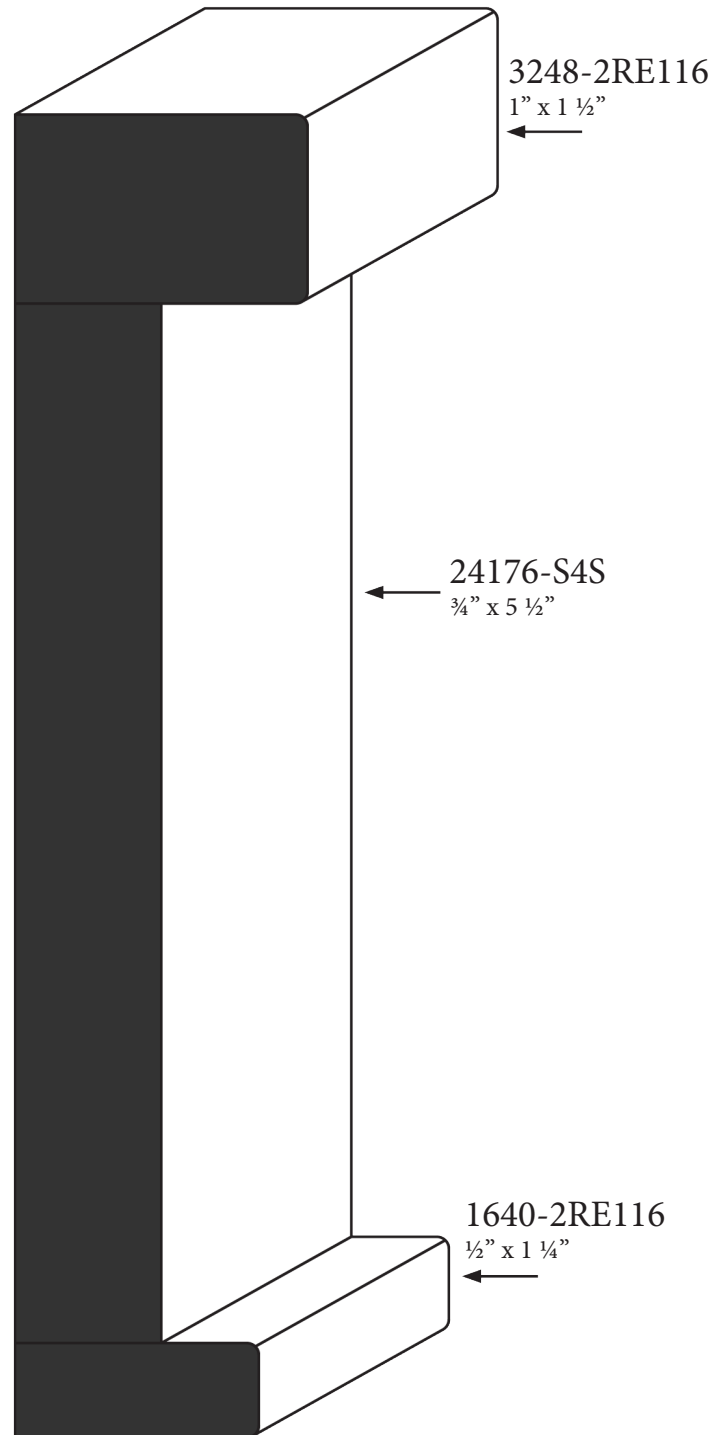
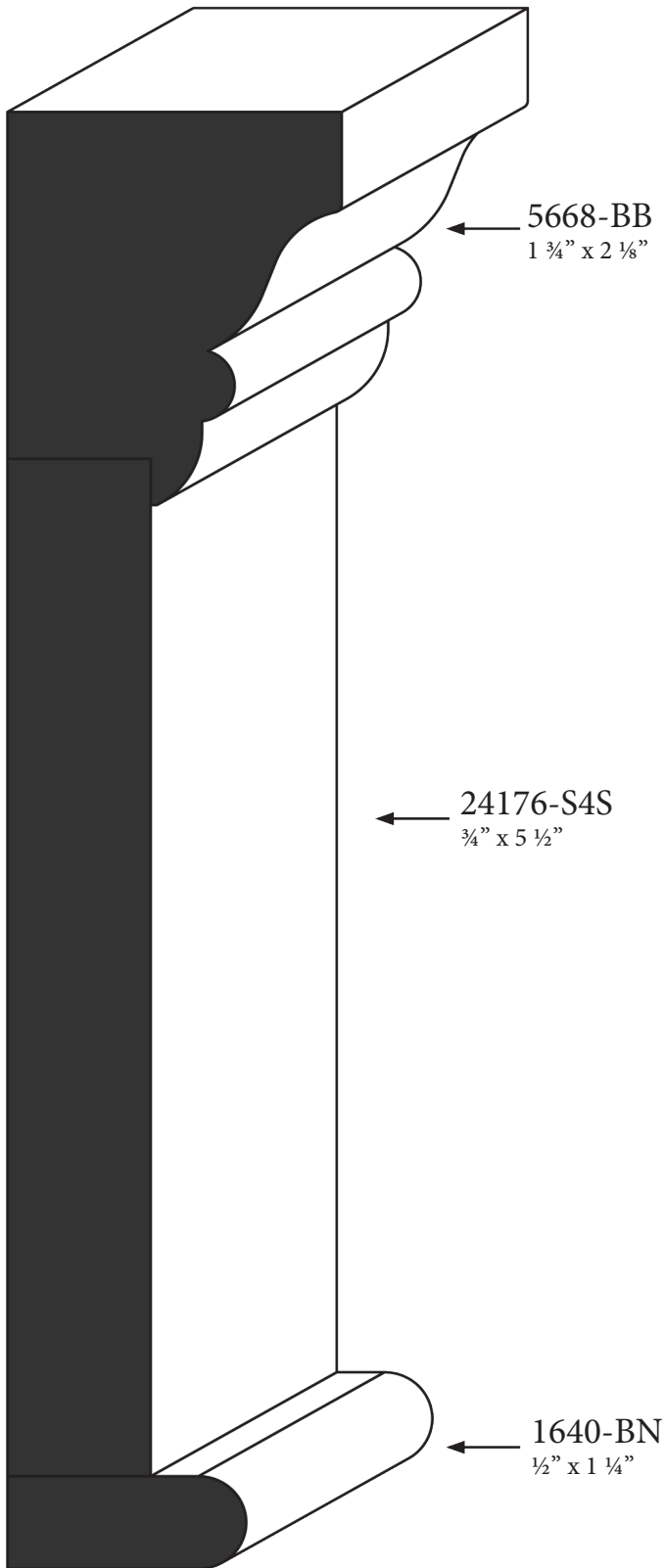

Choose from a variety of S4S widths to create a pediment appropriate for your individual ceiling height.

BASE CAPS & SHOE MOULDS

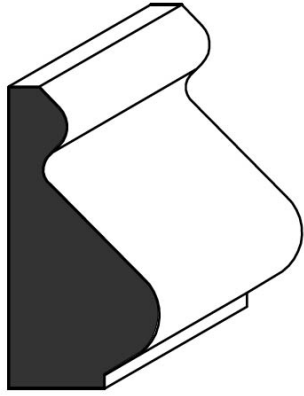

2244-B-Cap $1\frac{1}{16}'' \times 1\frac{3}{8}''$

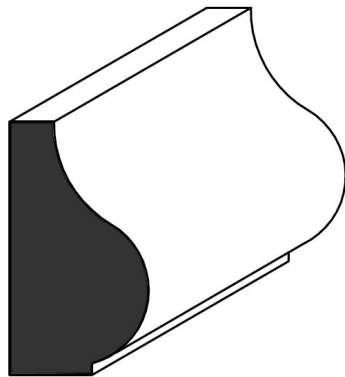

2240-IT-BC $1\frac{1}{16}'' \times 1\frac{1}{4}''$

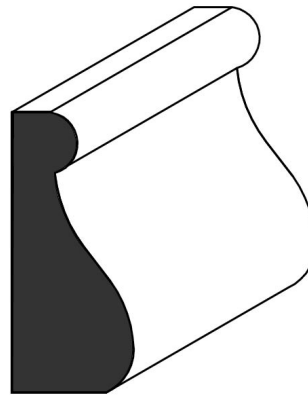

2148-CB-Cap $2\frac{1}{32}'' \times 1\frac{1}{2}''$

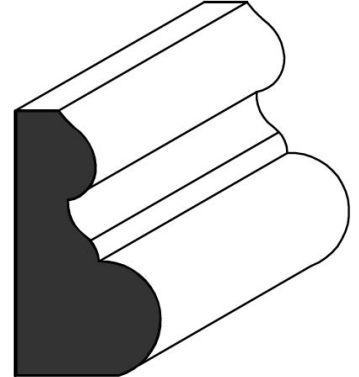

2444-B-CAP $\frac{3}{4}'' \times 1\frac{3}{8}''$

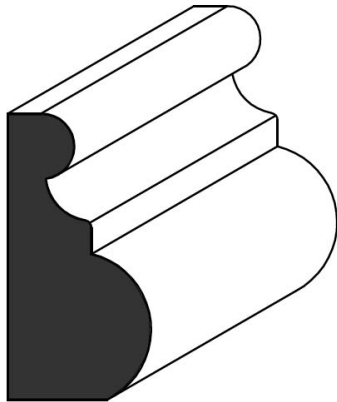

2448-US-BC $\frac{3}{4}'' \times 1\frac{1}{2}''$

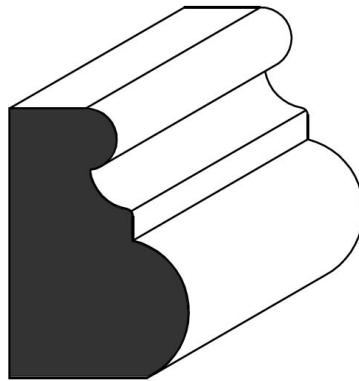

3248-US-BC $1'' \times 1\frac{1}{2}''$

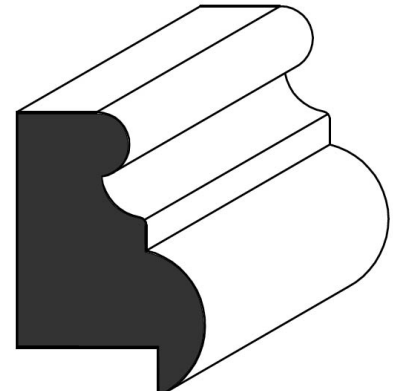

3248-ITC-BC $1'' \times 1\frac{1}{2}''$
($\frac{1}{4}'' \times \frac{3}{4}''$ rabet)

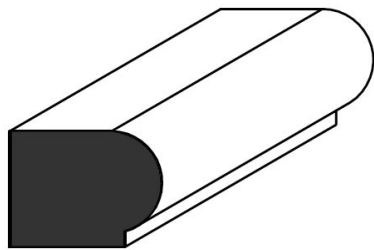

1723-BD-BC $1\frac{7}{32}'' \times 2\frac{3}{32}''$

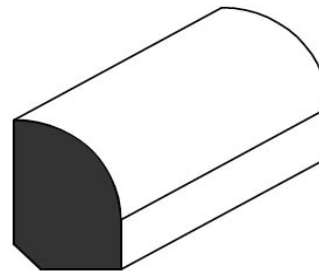

1624-A $\frac{1}{2}'' \times \frac{3}{4}''$

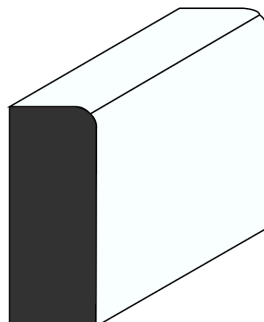

1640-1R18 $\frac{1}{2}'' \times 1\frac{1}{4}''$

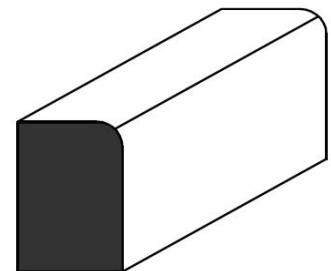

1624-B-SHOE $\frac{1}{2}'' \times \frac{3}{4}''$

BASES



22232-CB
1¹/₁₆" x 7 1/4"

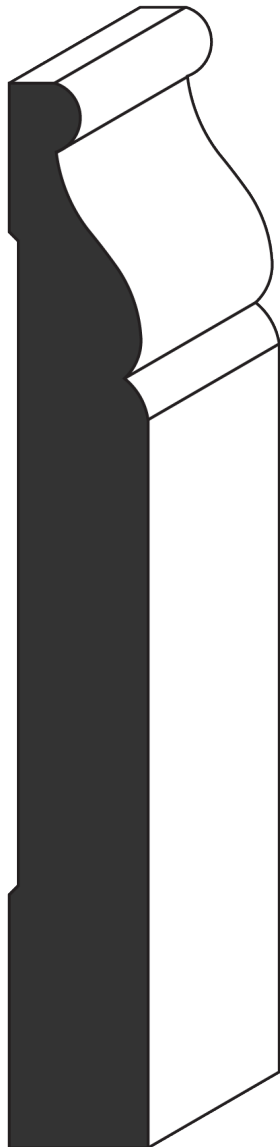

22168-CB
1¹/₁₆" x 5 1/4"

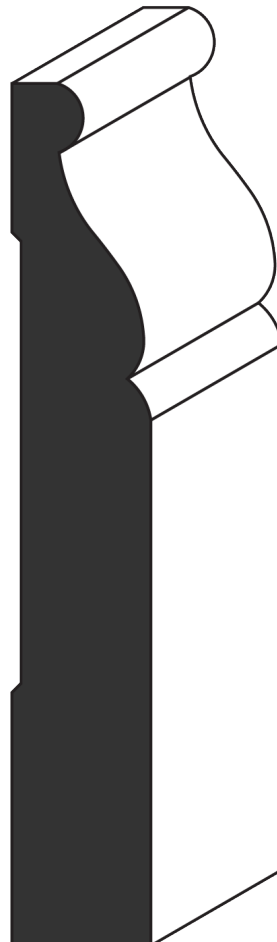

22136-CB
1¹/₁₆" x 4 1/4"

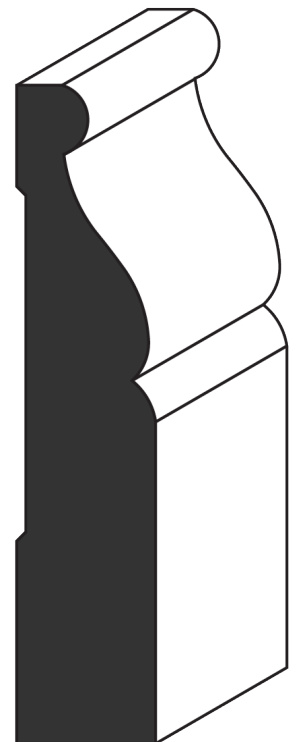

22104-CB
1¹/₁₆" x 3 1/4"

BASES



18232-B
 $\frac{9}{16}$ " x $7\frac{1}{4}$ "

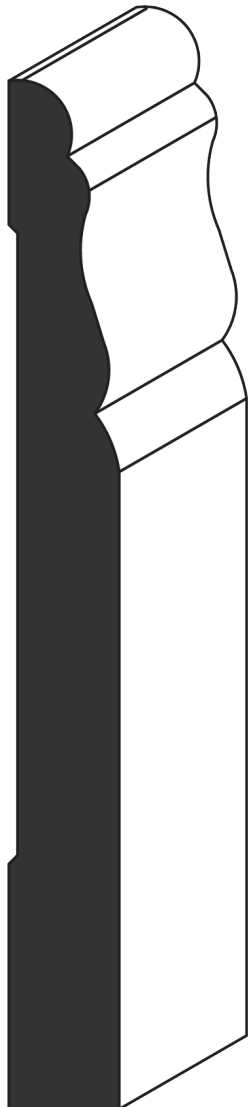

18168-B
 $\frac{9}{16}$ " x $5\frac{1}{4}$ "

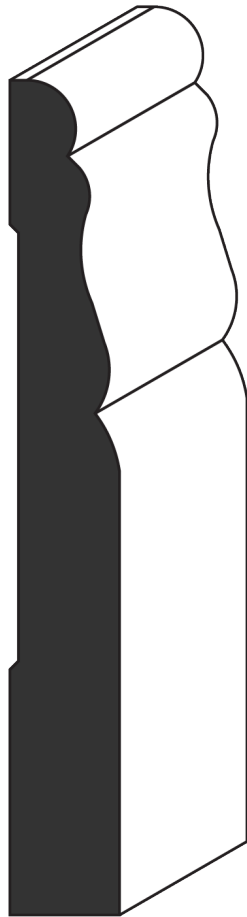

18136-B
 $\frac{9}{16}$ " x $4\frac{1}{4}$ "

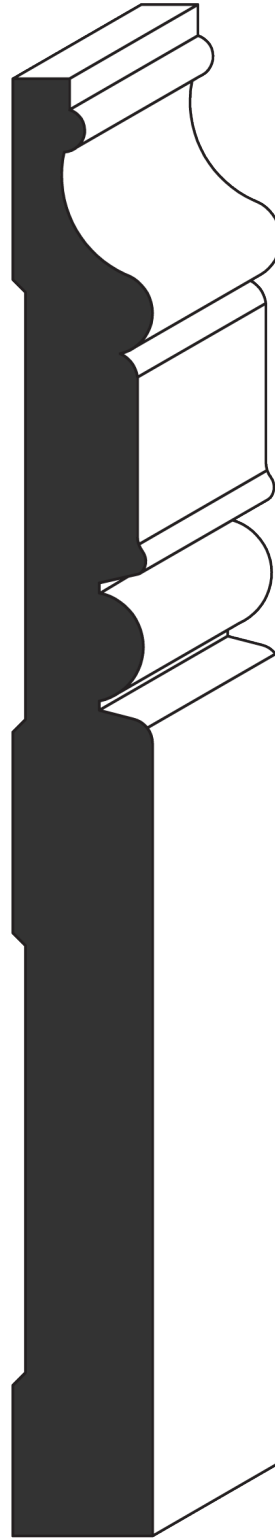

22232-E-B
 $1\frac{1}{16}$ " x $7\frac{1}{4}$ "

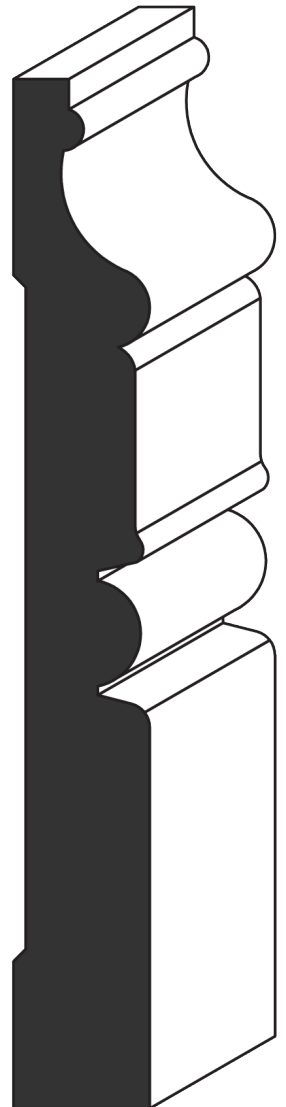

22168-E-B
 $1\frac{1}{16}$ " x $5\frac{1}{4}$ "

BASES

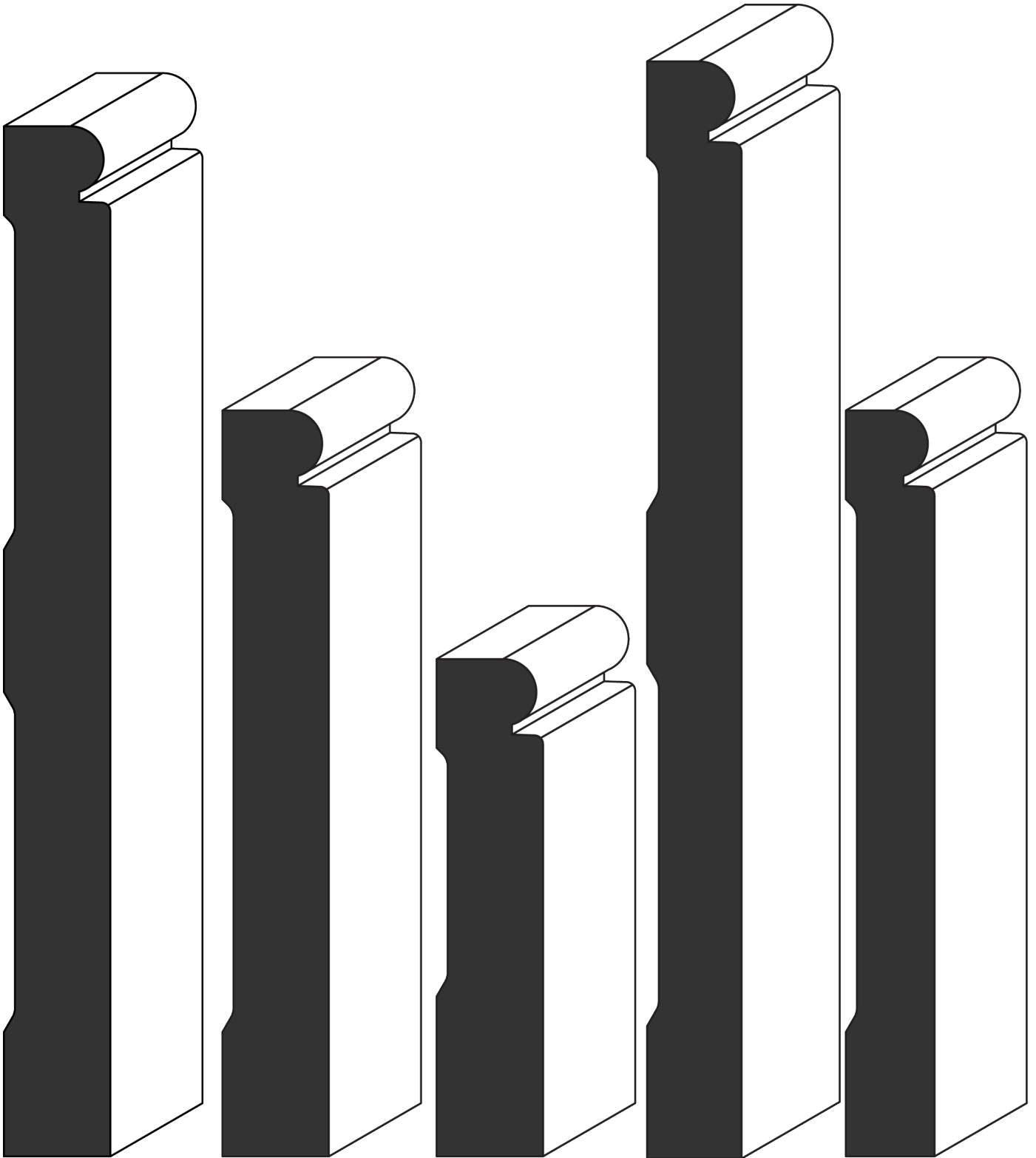

24232-BD-B
3/4" x 7 1/4"

24168-BD-B
3/4" x 5 1/4"

24112-BD-B
3/4" x 3 1/2"

20232-BD-B
5/8" x 7 1/4"

20168-BD-B
5/8" x 5 1/4"

BASES

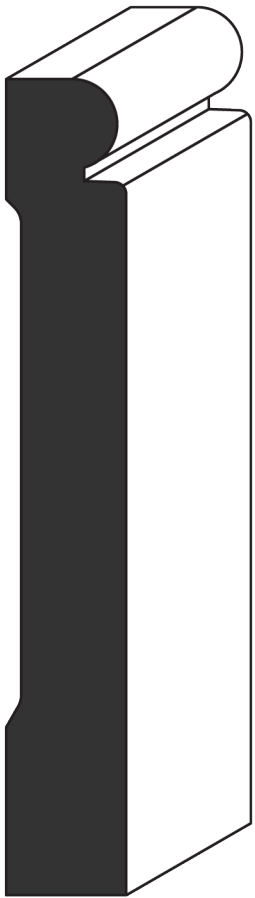

20136-BD-B
5/8" x 4 1/4"



20232-1R18-B
5/8" x 7 1/4"



20168-1R18-B
5/8" x 5 1/4"



20136-1R18-B
5/8" x 4 1/4"

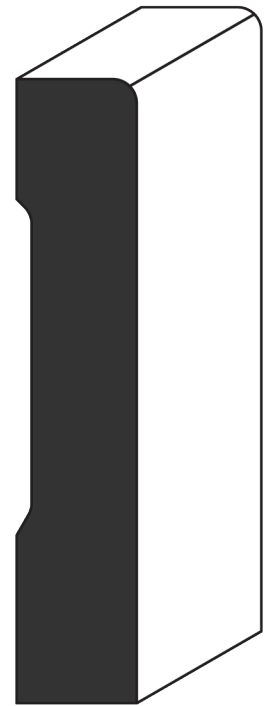

20104-1R18-B
5/8" x 3 1/4"

BASES



16104-B
1/2" x 3 1/4"



18168-OG-B
9/16" x 5 1/4"



18136-OG-B
9/16" x 4 1/4"



18104-OG-B
9/16" x 3 1/4"



14168-1B14-B
7/16" x 5 1/4"

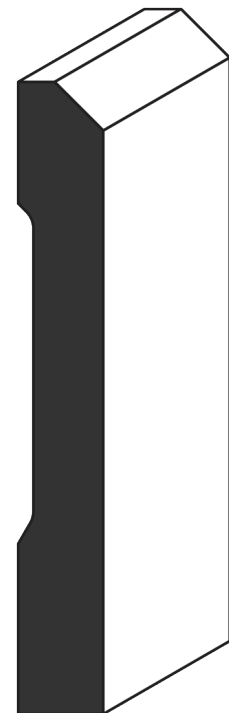

14104-1B14-B
7/16" x 3 1/4"

PRIMED MDF BASES



PFB 20232-1R18-B
5/8" x 7 1/4"

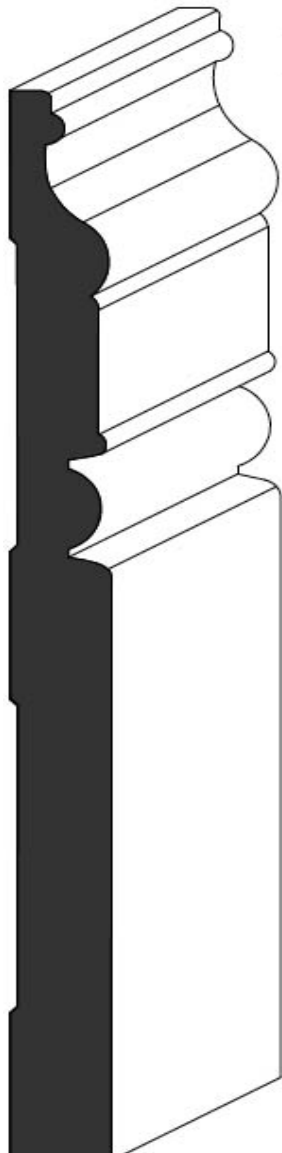

15M232-E-B
15mm x 7 1/4"

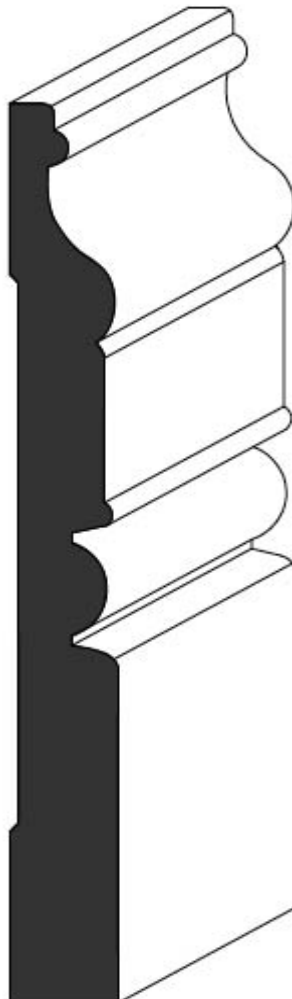

15M168-E-B
15mm x 5 1/4"

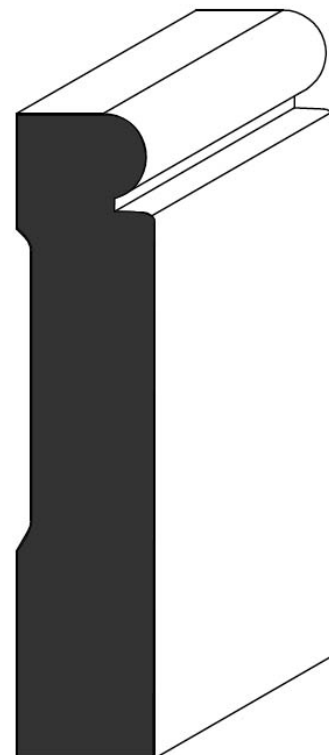

24112-BD-B
3/4" x 3 1/2"

PRIMED MDF BASES & BASE CAPS

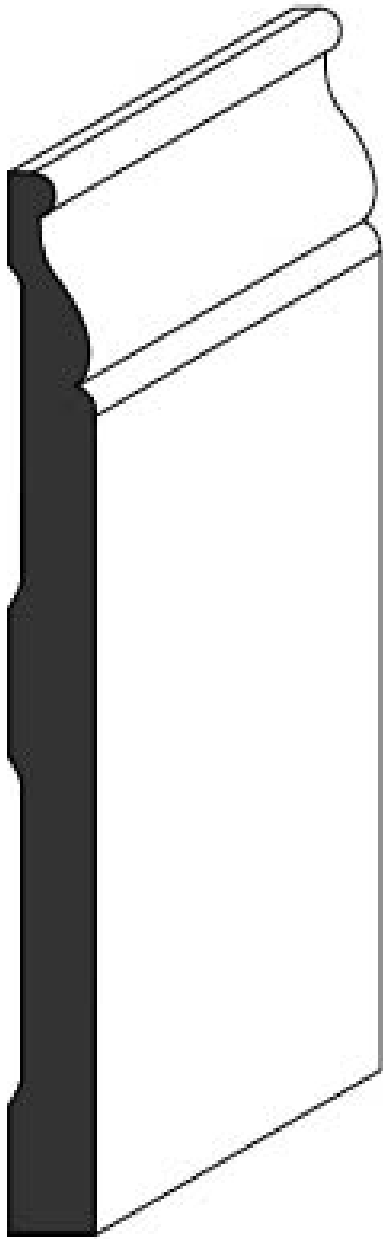

15M232-CB
15mm x 7 1/4"

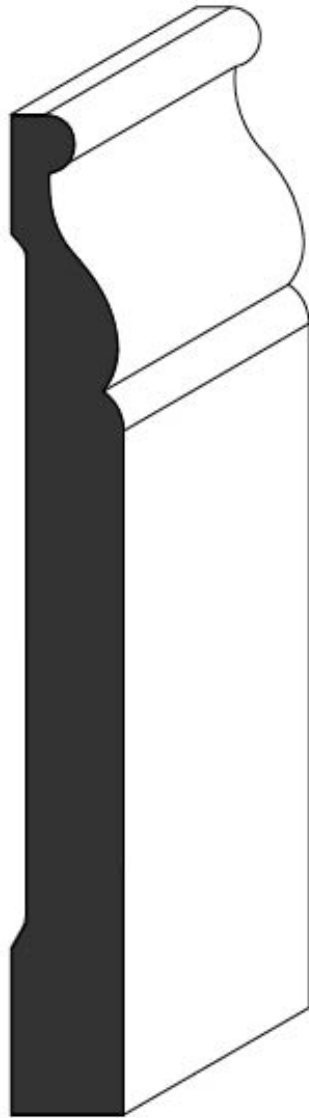

15M168-CB
15mm x 5 1/4"

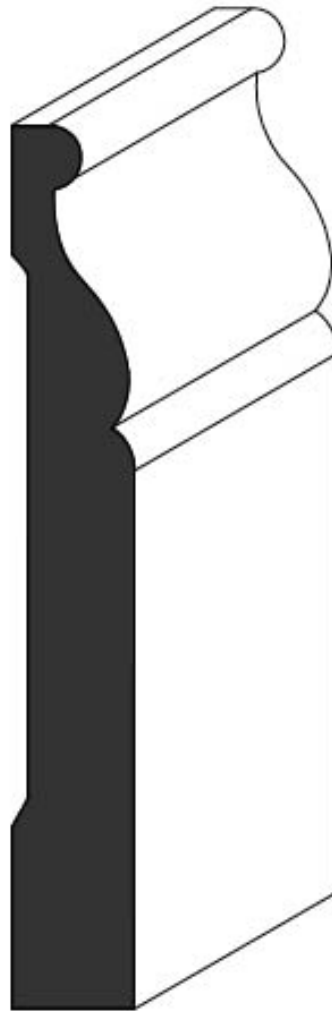

15M136-CB
15mm x 4 1/4"

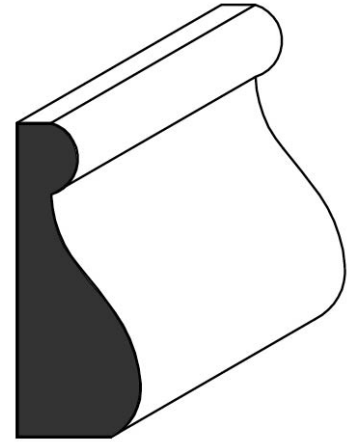

15M48-CB-CAP
15mm x 1 1/2"

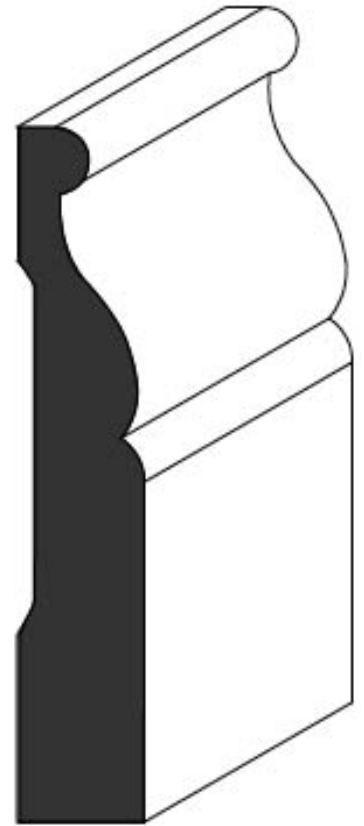

15M104-CB
15mm x 3 1/4"

PRIMED MDF VALUE SERIES BASES

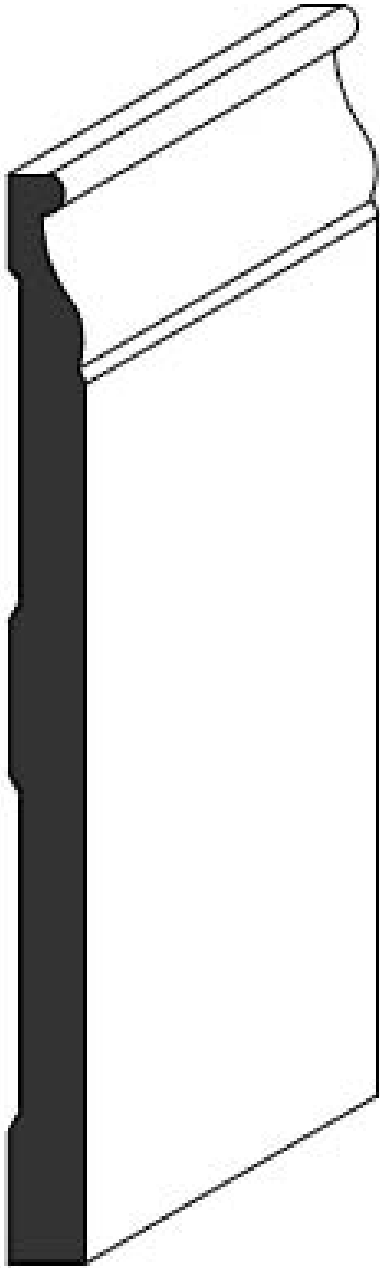

16232-VS-CB

1/2" x 7 1/4"

Also Available:
16296-VS-CB 1/2" x 9 1/4"

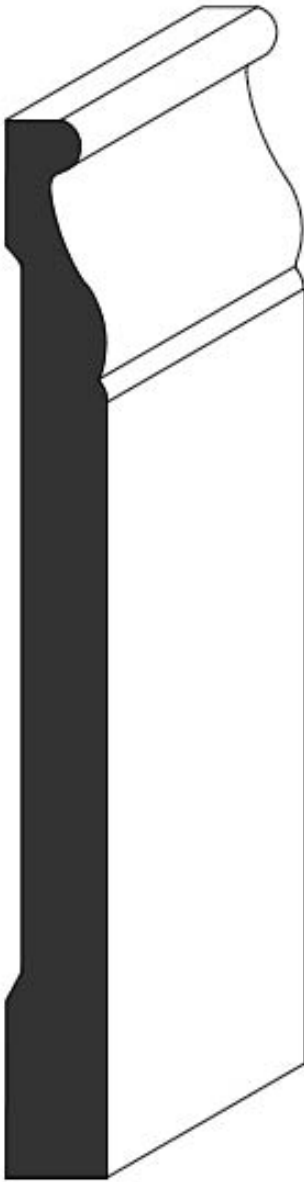

16168-VS-CB

1/2" x 5 1/4"

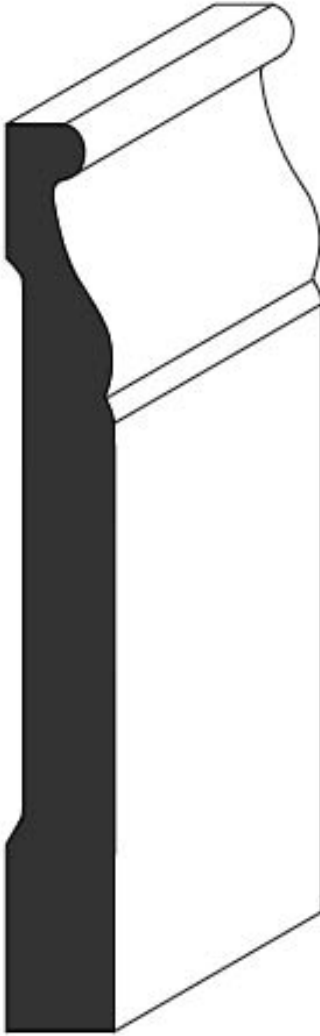

16136-VS-CB

1/2" x 4 1/4"

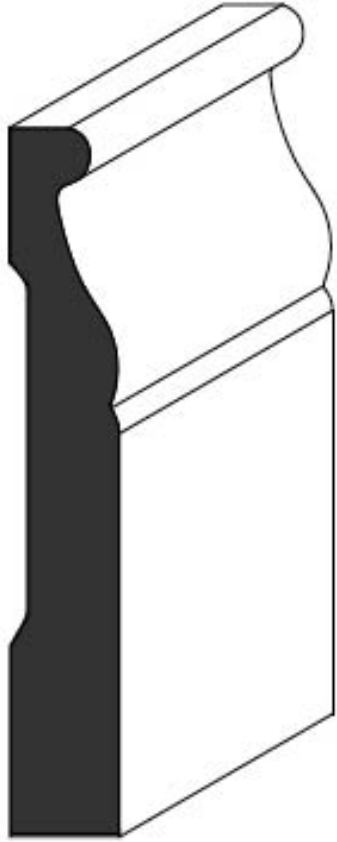

16104-VS-CB

1/2" x 3 1/4"

GISSO PINE BASES

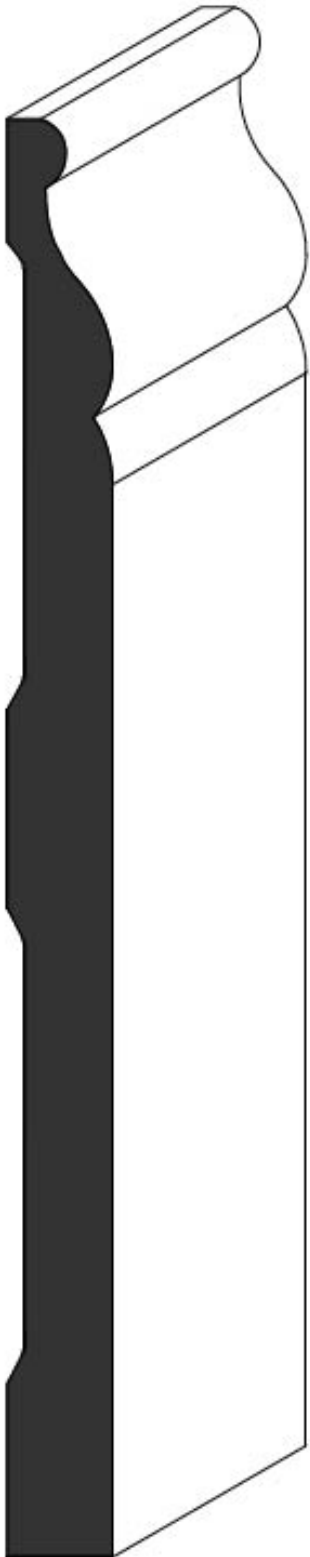

PFP 18232-CB
 $\frac{1}{16}$ " x 7 $\frac{1}{4}$ " x 16'

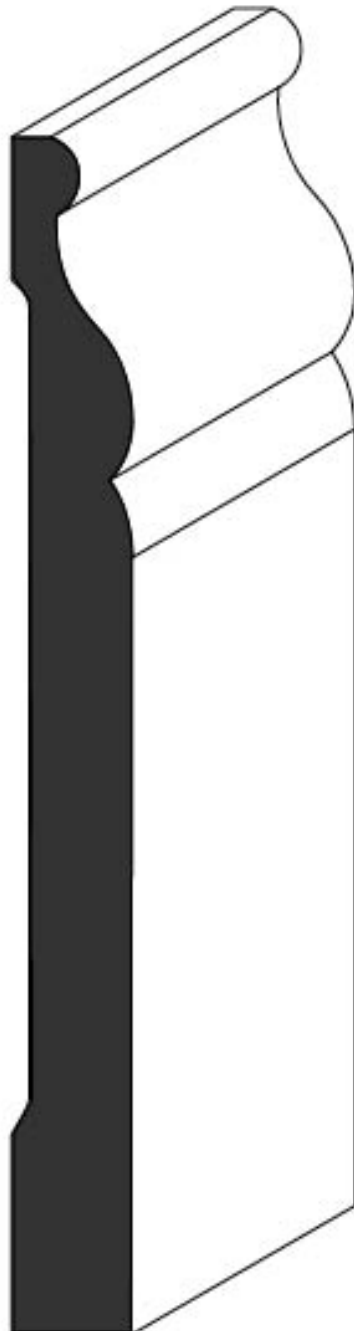

PFP 18168-CB
 $\frac{1}{16}$ " x 5 $\frac{1}{4}$ " x 16'

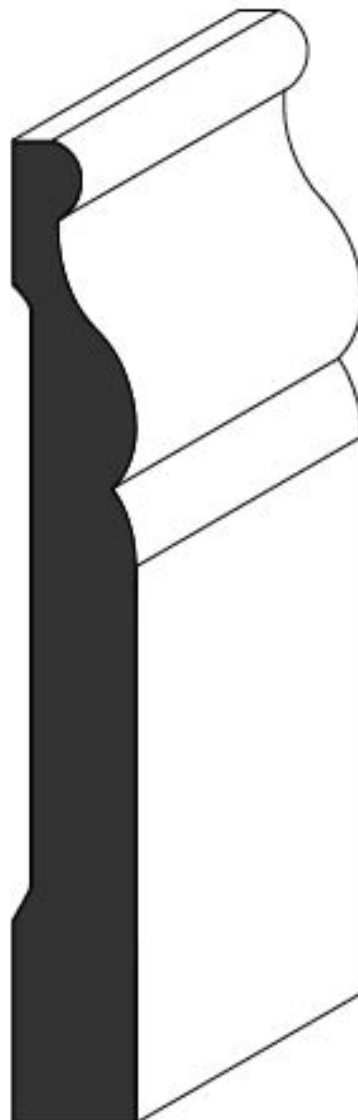

PFP 18136-CB
 $\frac{1}{16}$ " x 4 $\frac{1}{4}$ " x 16'

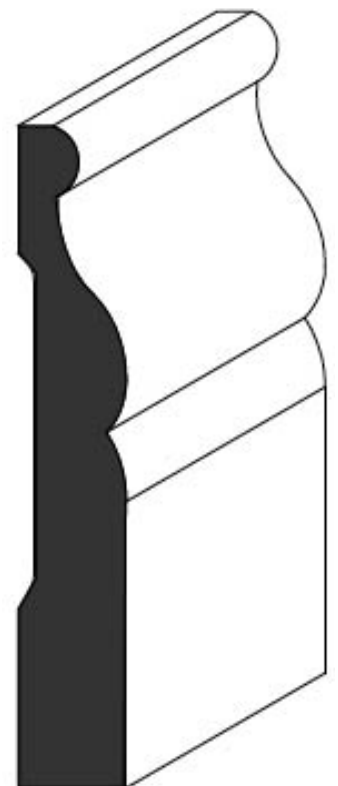

PFP 18104-CB
 $\frac{1}{16}$ " x 3 $\frac{1}{4}$ " x 16'

GESSO PINE BASES

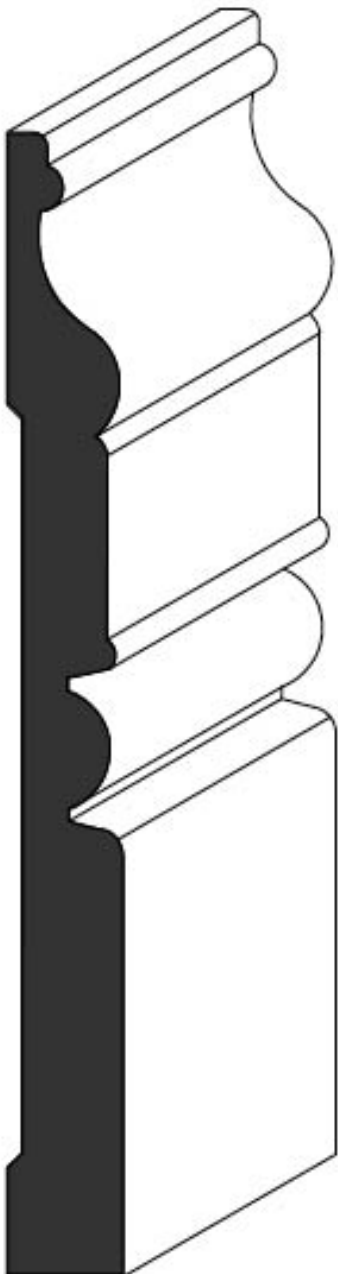

PFP 17168-EB
 $1\frac{7}{32}$ " x $5\frac{1}{4}$ " x 16'



PFP 17168-1R18-B
 $7\frac{3}{32}$ " x $5\frac{1}{4}$ " x 16'



PFP 17136-1R18-B
 $1\frac{7}{32}$ " x $4\frac{1}{4}$ " x 16'

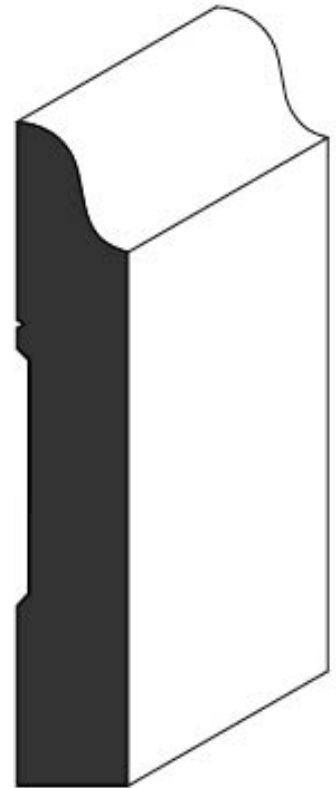

PFP WM663
 $\frac{9}{16}$ " x $3\frac{1}{4}$ " x 16'

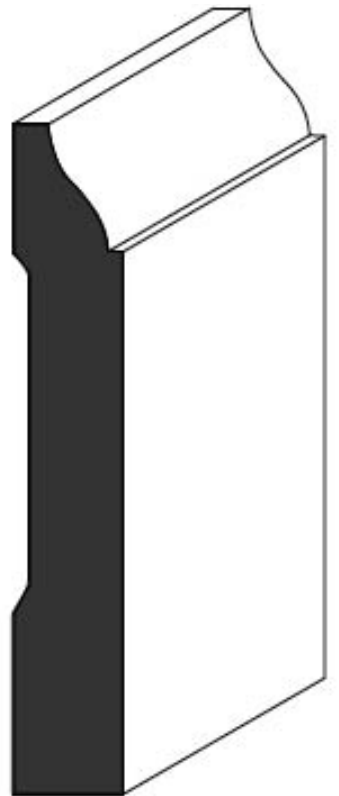

PFP WM623
 $\frac{9}{16}$ " x $3\frac{1}{4}$ " x 16'

VINTAGE SERIES BASES

*Our Vintage Series profiles may not be in stock. For any profiles that are not in stock, there will be a 2 week lead time.

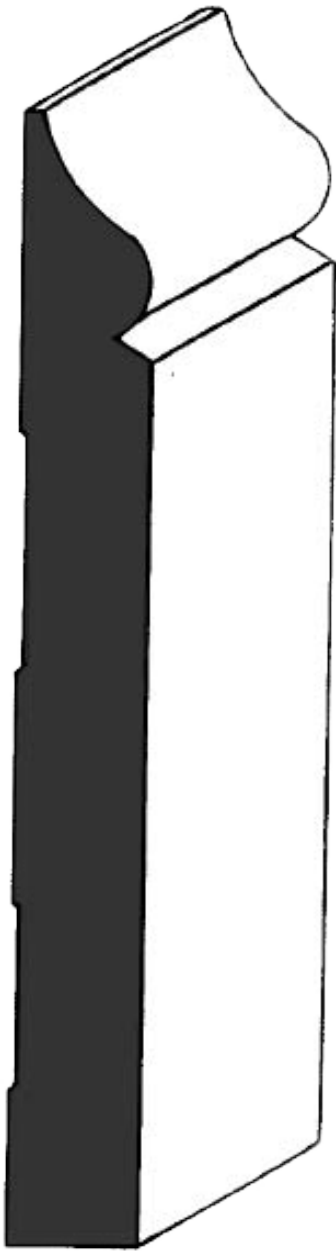

C-701
5/8" x 5 1/2"



703-5 * This profile is available in multiple height options.
5/6" x 5 1/2"

CROWNS

Degree shown on crown mouldings = spring angle

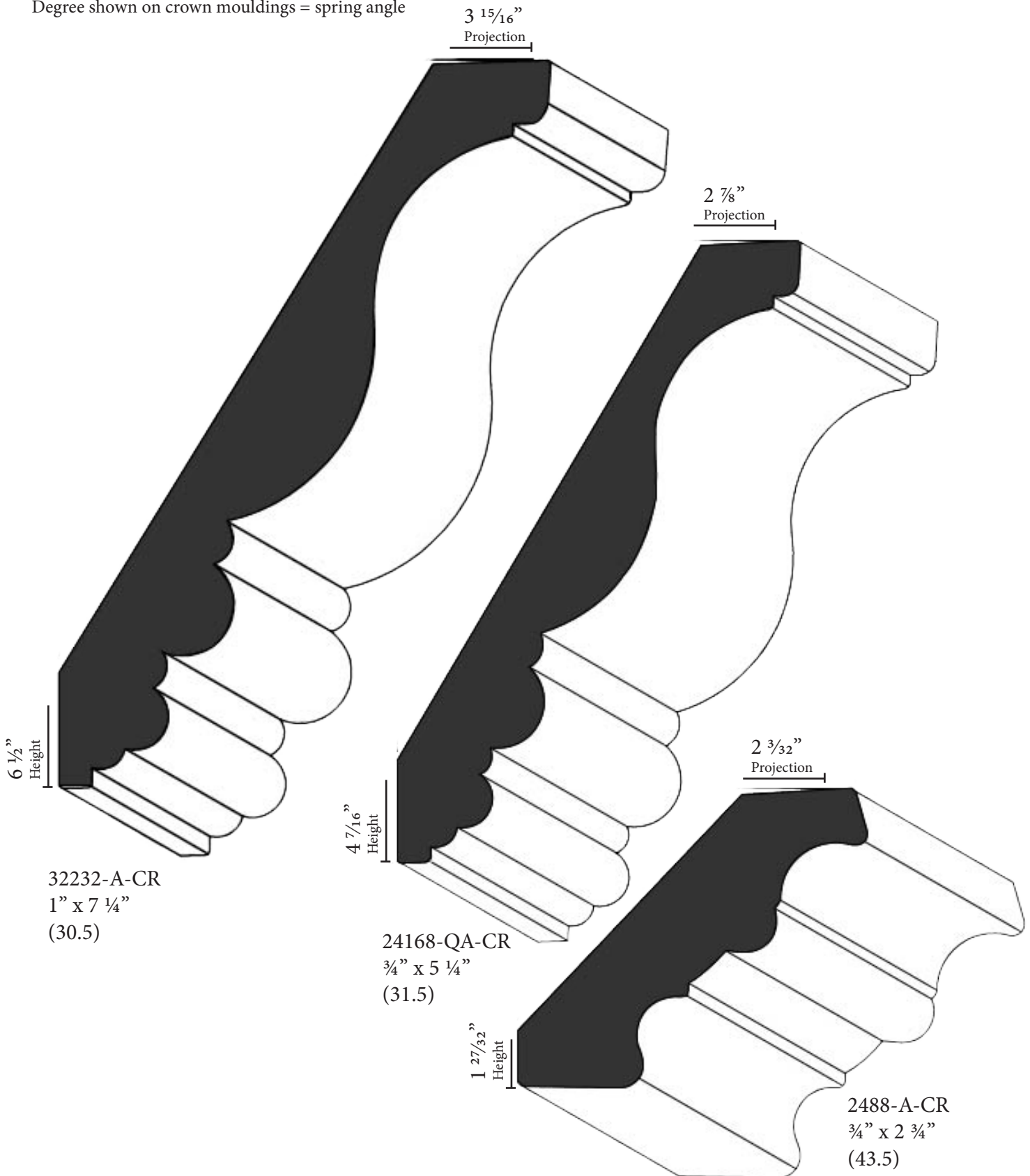

CROWNS

Degree shown on crown mouldings = spring angle

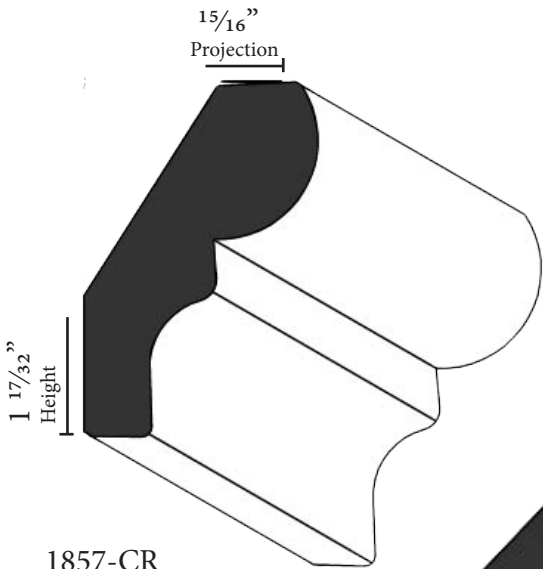

1857-CR
 $\frac{9}{16}$ " X $1 \frac{25}{32}$ "
 (32.5)

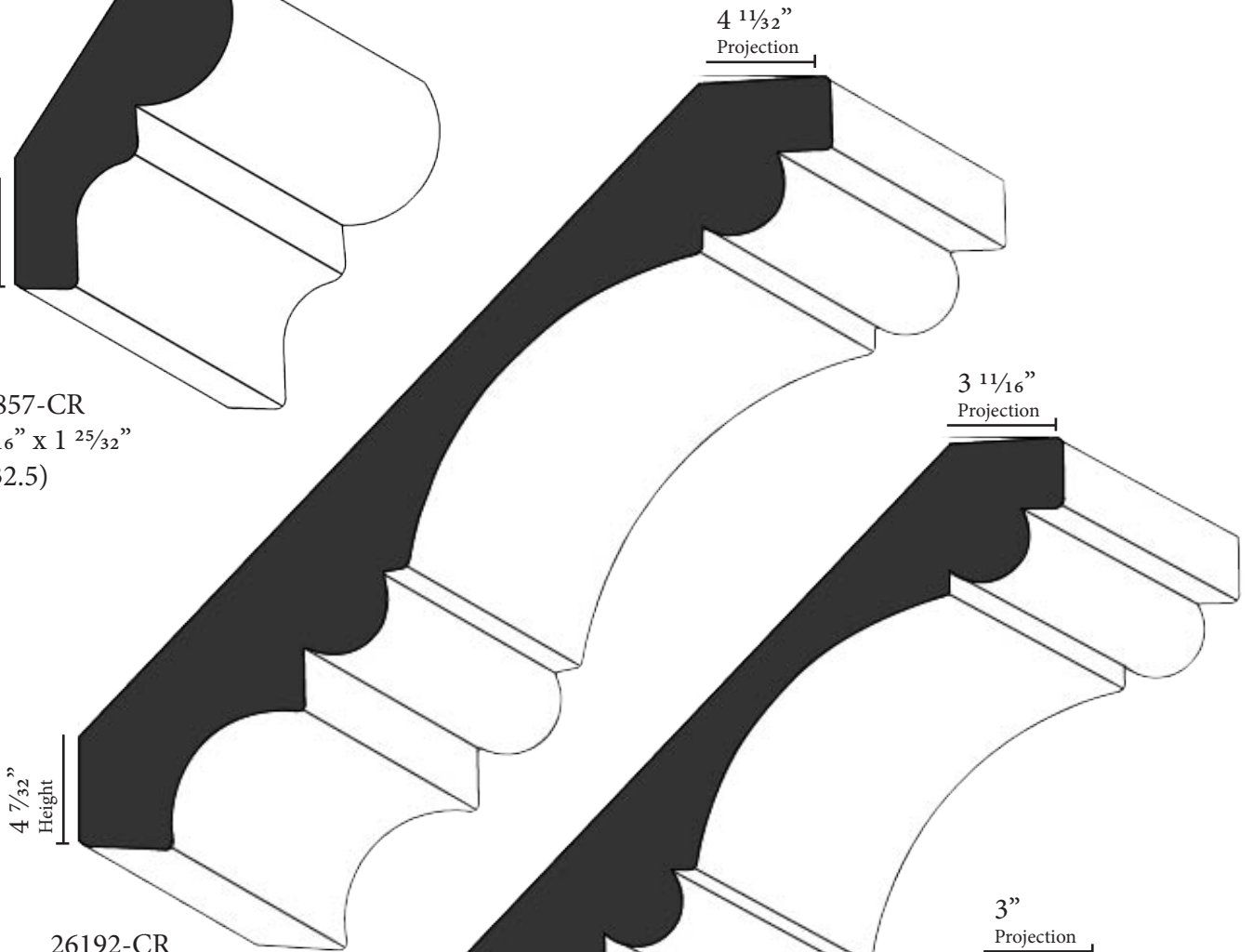

26192-CR
 $1 \frac{13}{16}$ " X 6"
 (43.5)

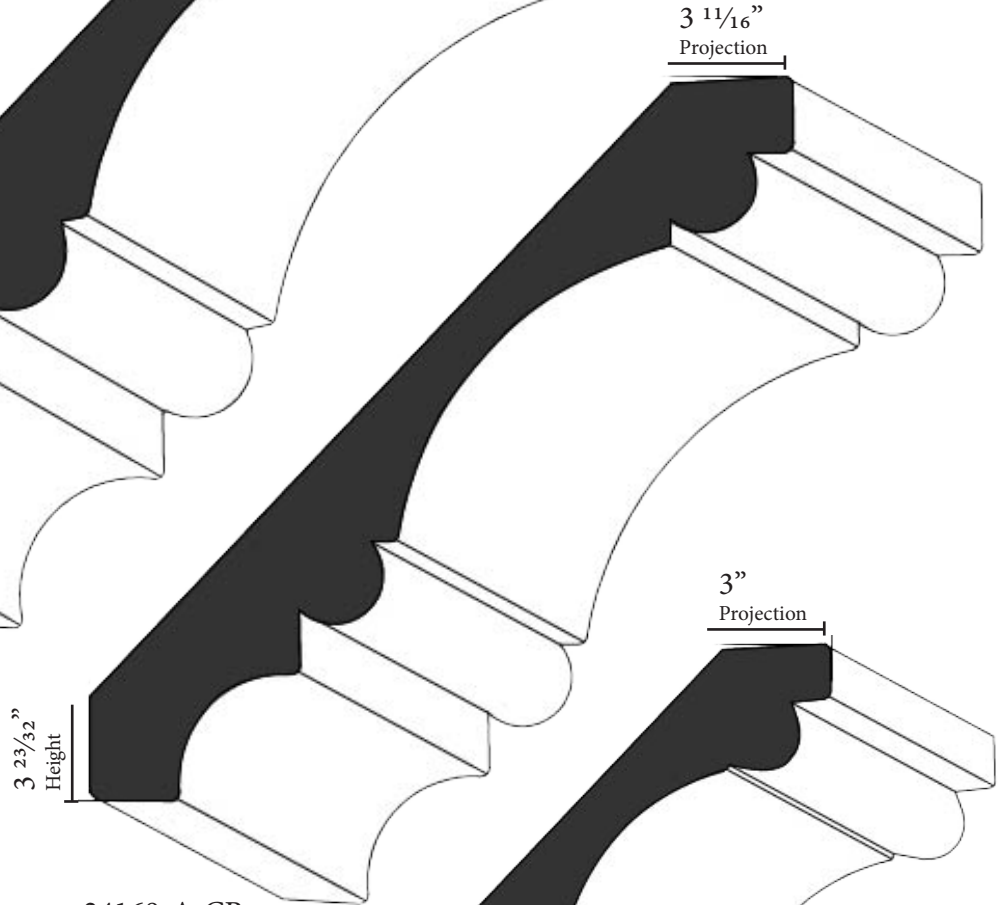

24168-A-CR
 $\frac{3}{4}$ " X $5 \frac{1}{4}$ "
 (43.5)

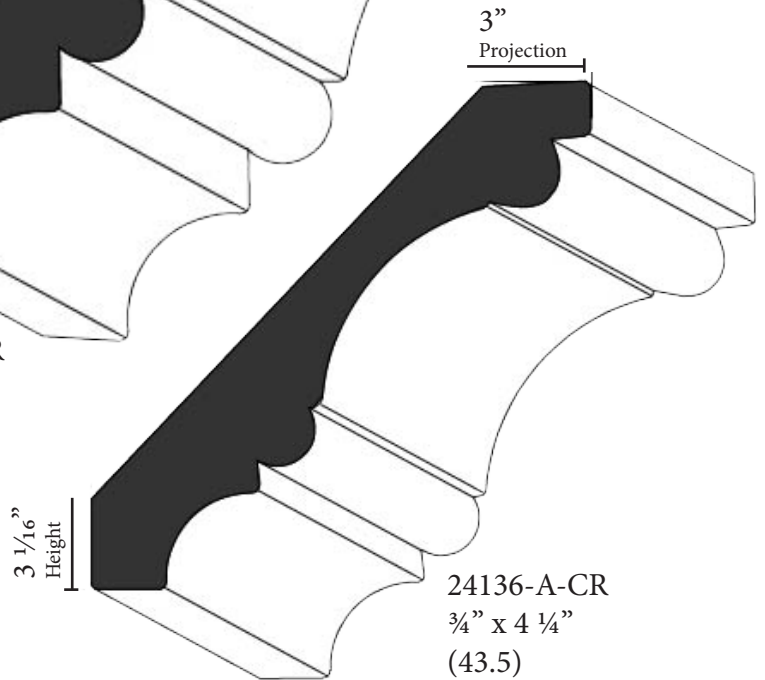

24136-A-CR
 $\frac{3}{4}$ " X $4 \frac{1}{4}$ "
 (43.5)

CROWNS

Degree shown on crown mouldings = spring angle

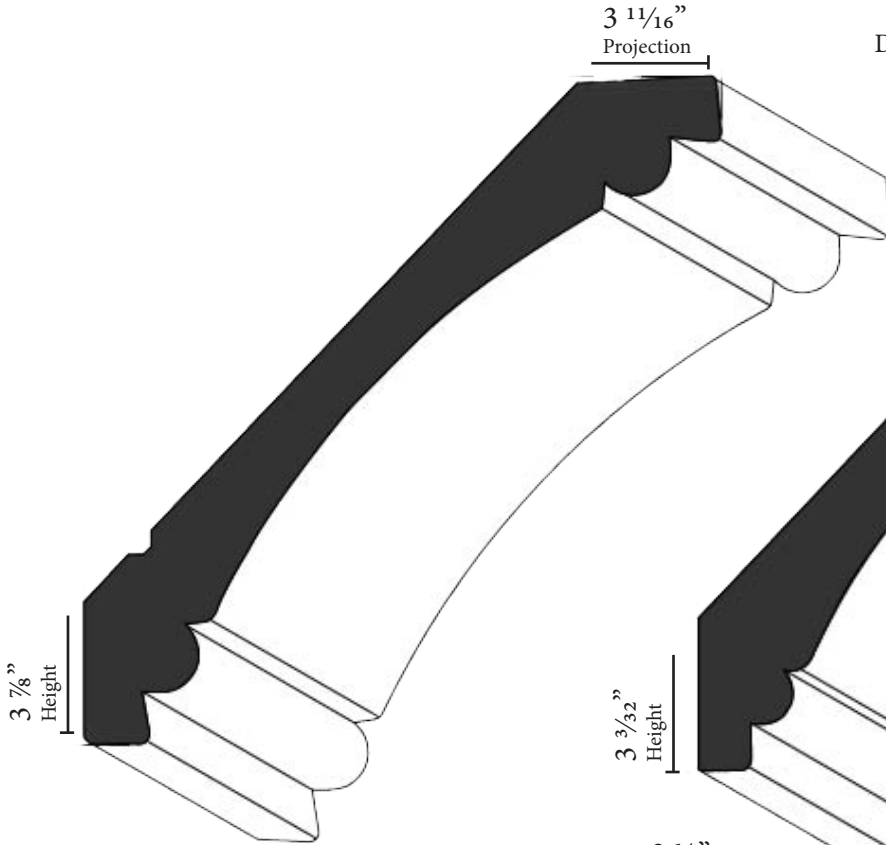

26168-C-CR
13/16" x 5 1/4"
(43.5)

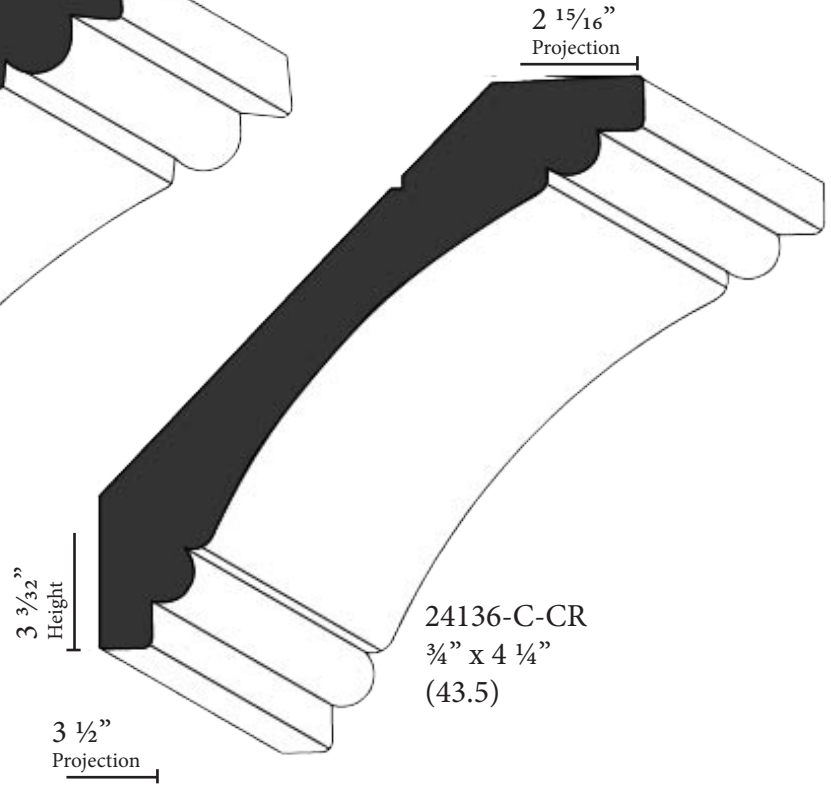

24136-C-CR
3/4" x 4 1/4"
(43.5)

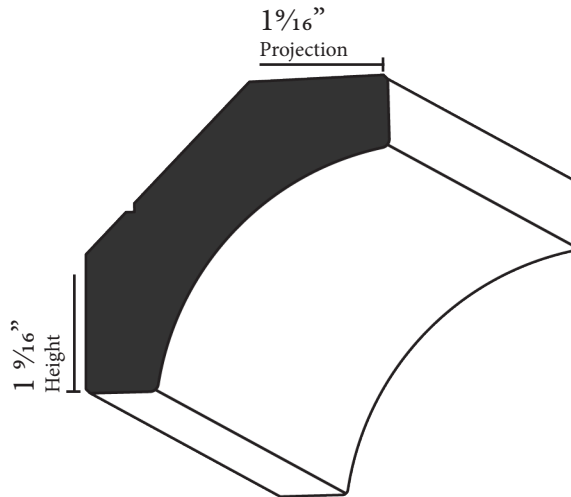

CROWNS

Degree shown on crown mouldings = spring angle

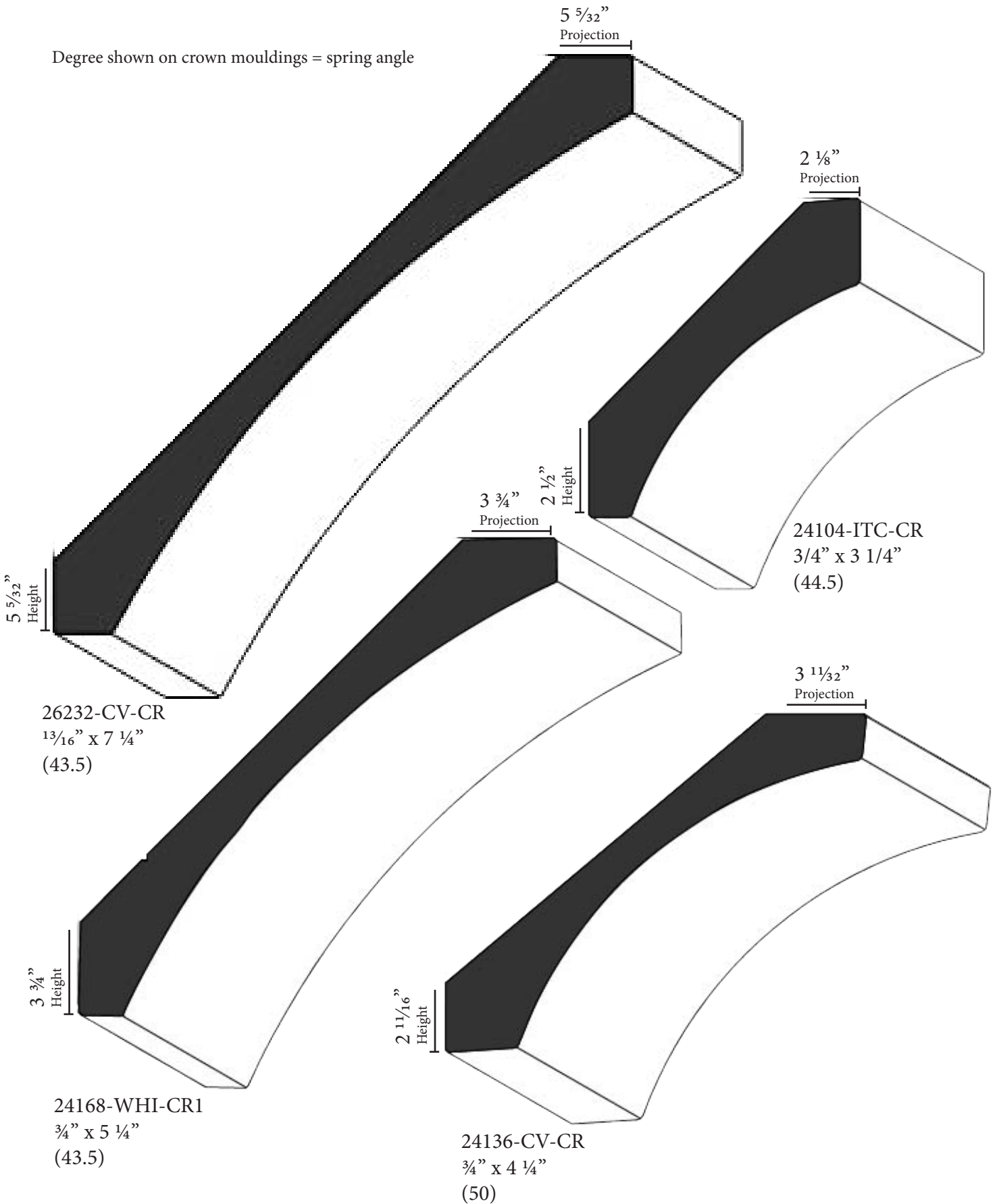

CROWNS

Degree shown on crown mouldings = spring angle

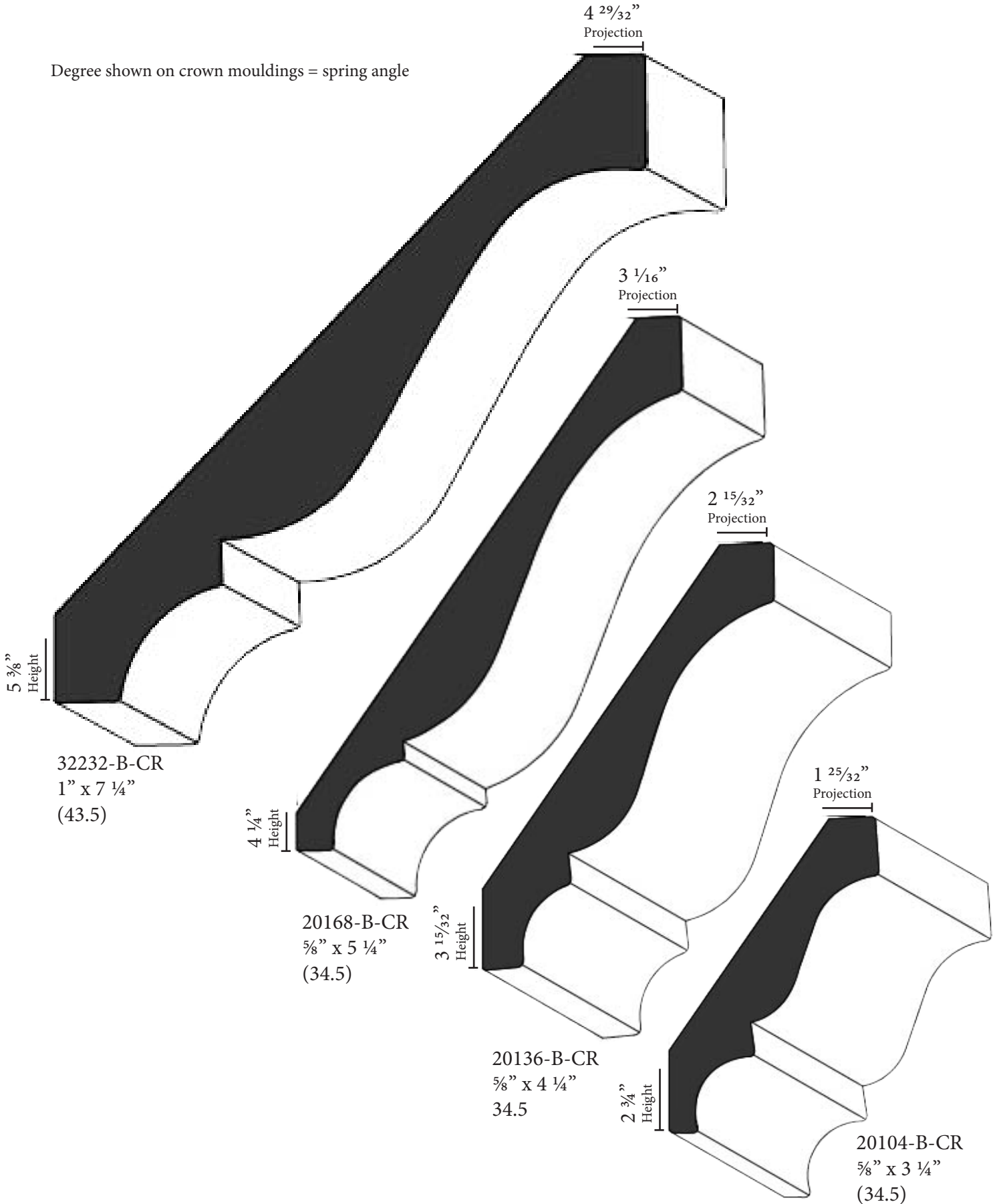

PRIMED MDF CROWNS

Degree shown on crown mouldings = spring angle

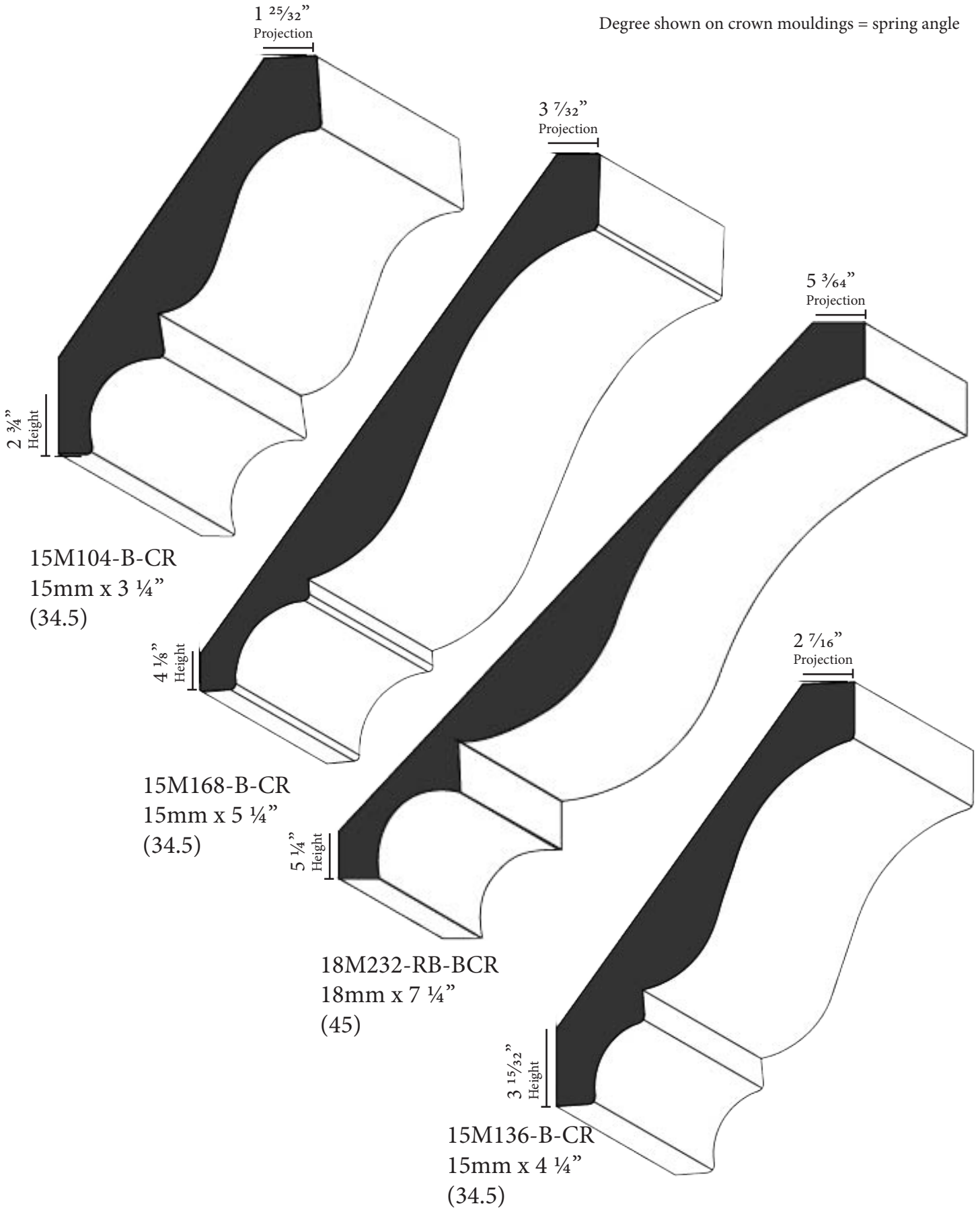

PRIMED MDF CROWNS

Degree shown on crown mouldings = spring angle

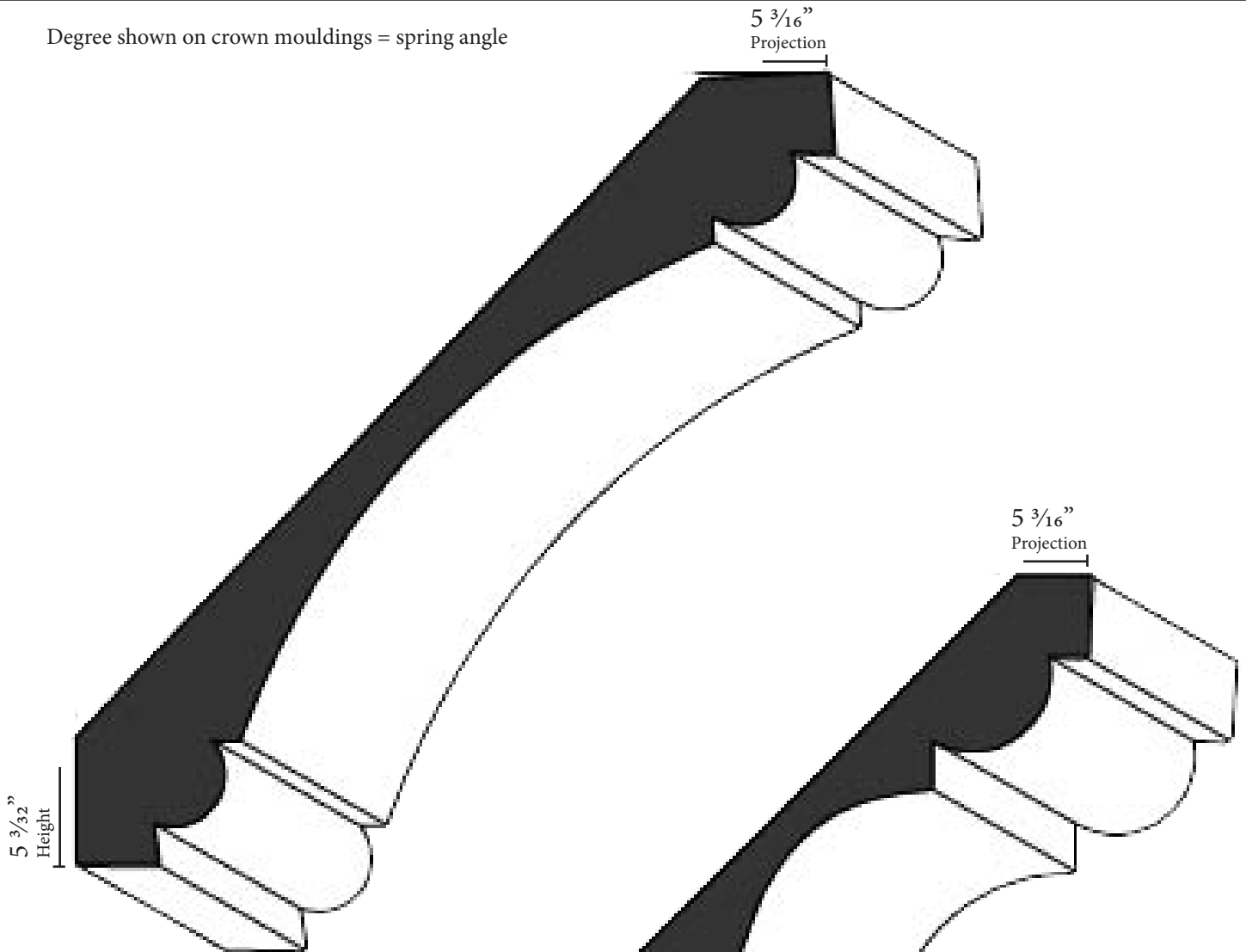

25M232-C-CR
25mm x 7 1/4"
(43.5)

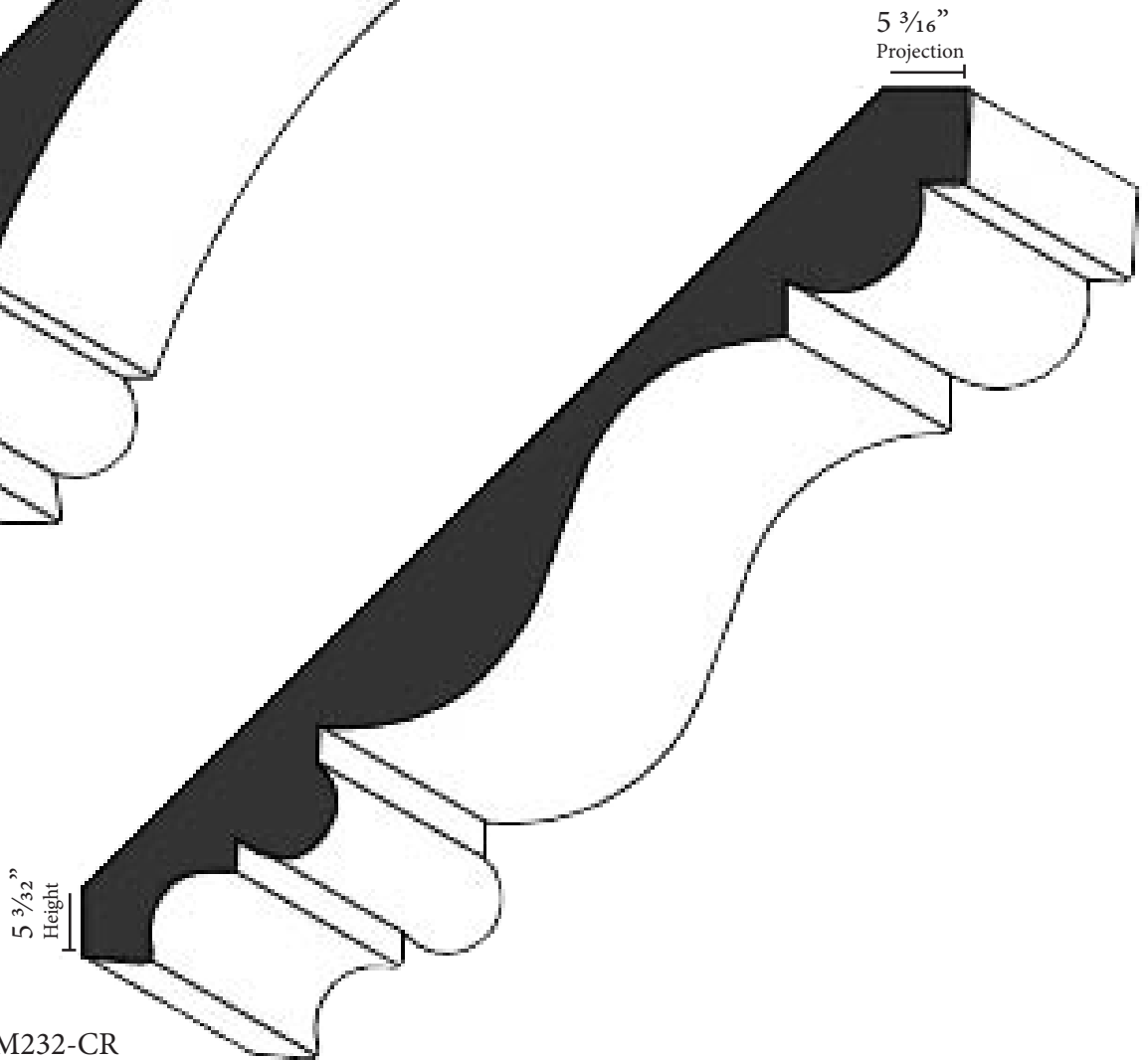

20M232-CR
20mm x 7 1/4"
(45)

PRIMED MDF CROWNS

Degree shown on crown mouldings = spring angle

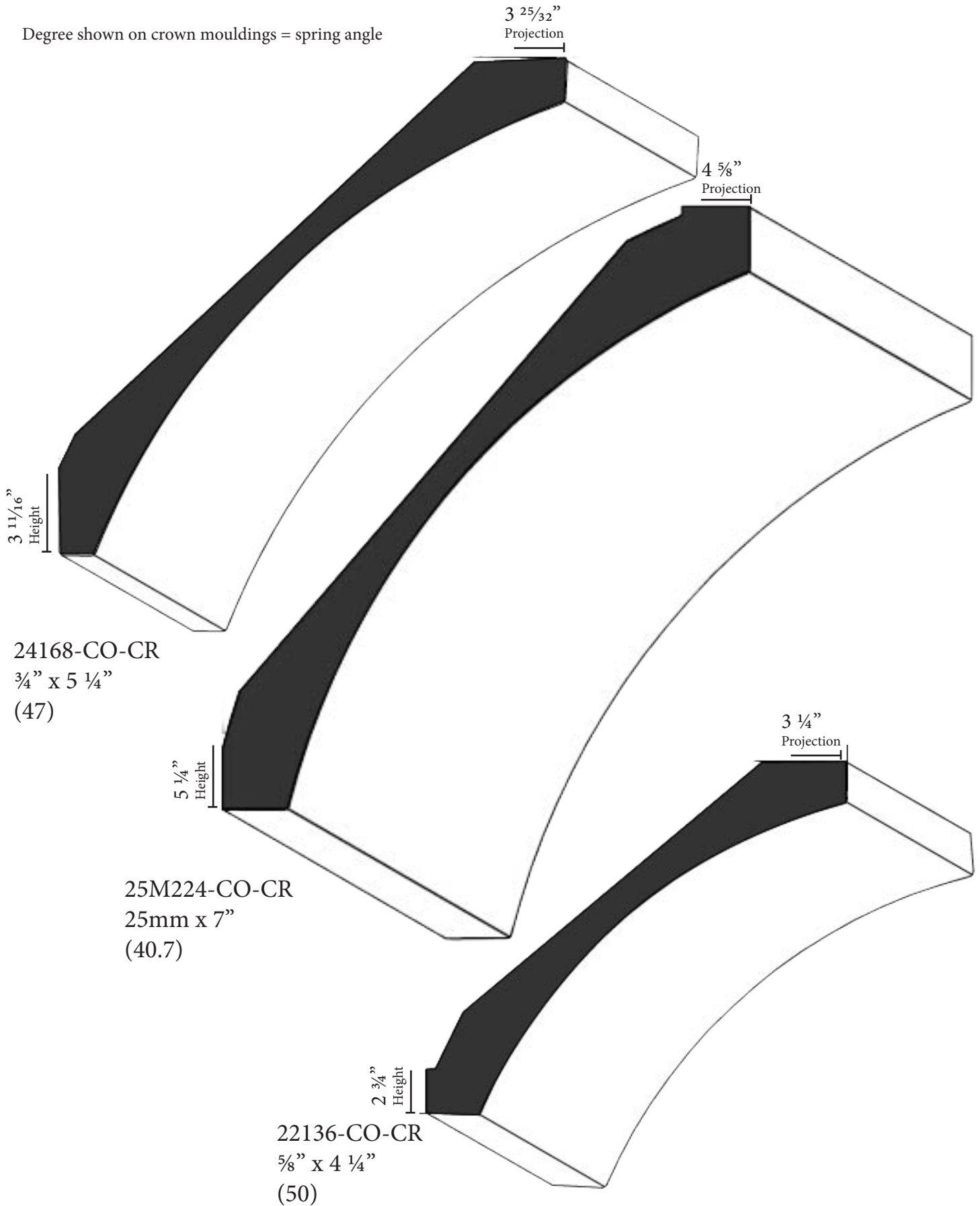

PRIMED MDF CROWNS & CHAIR RAILS

Degree shown on crown mouldings = spring angle

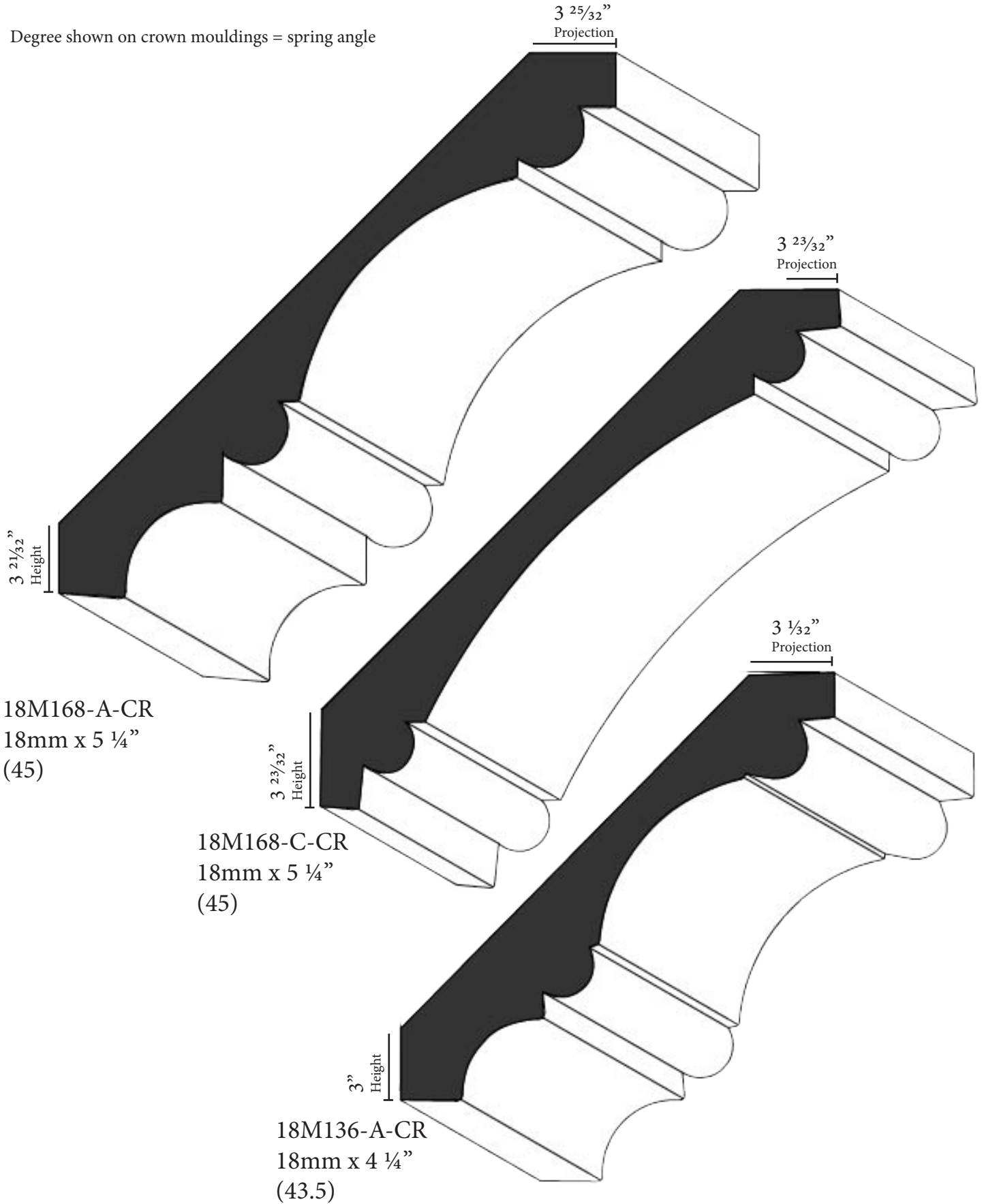

PRIMED MDF CROWN & BEADED SHEET STOCK

Degree shown on crown mouldings = spring angle

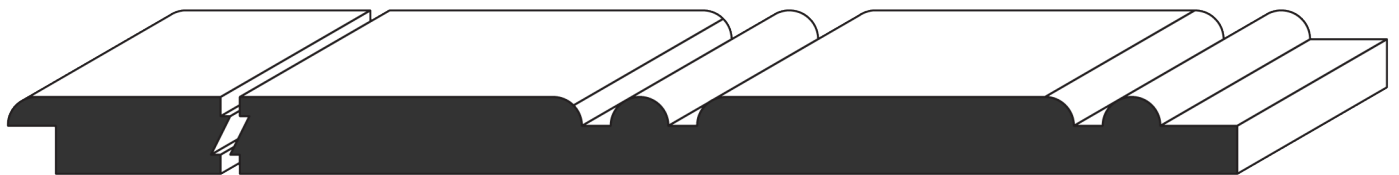
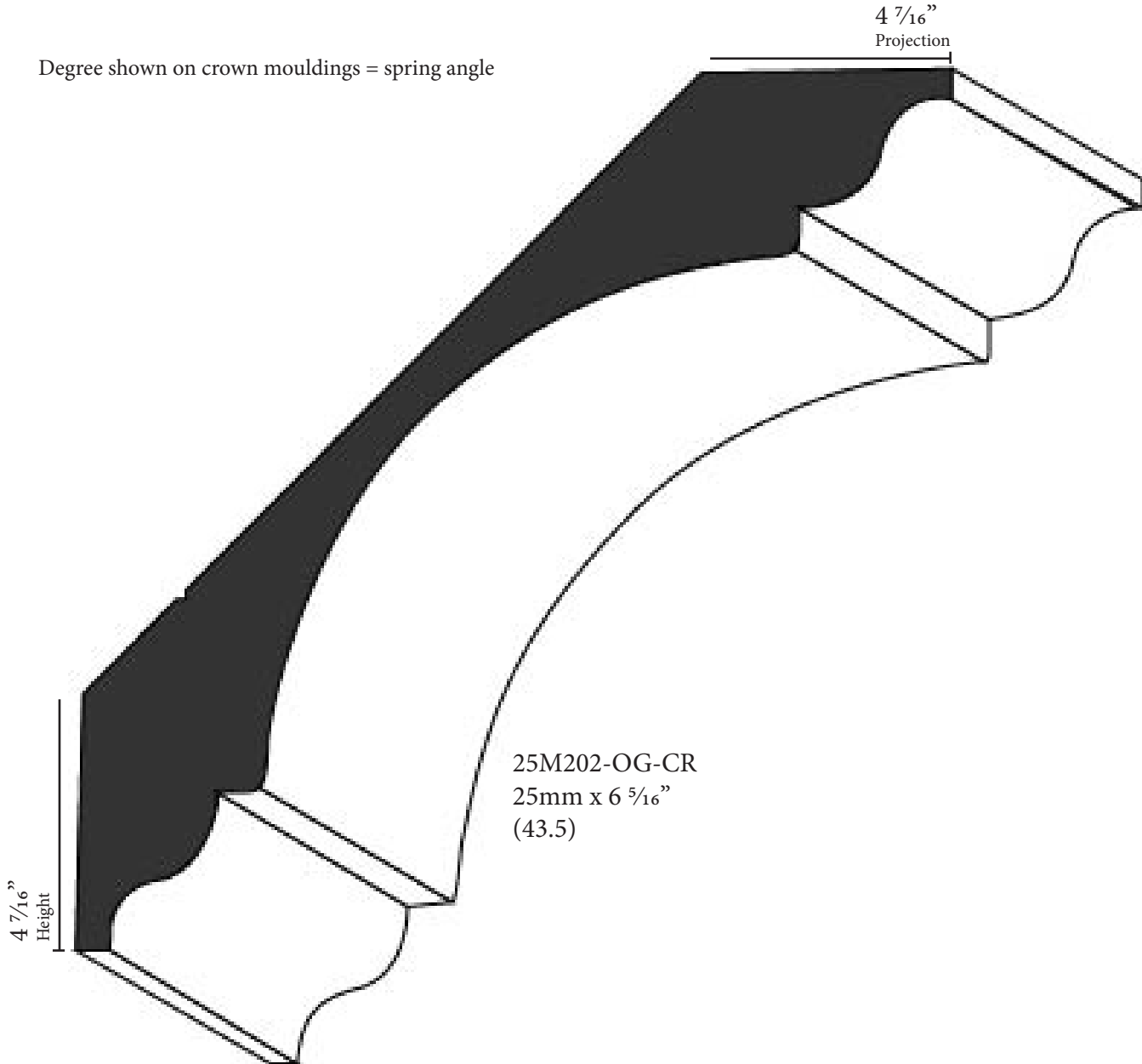

MDF 1248-ITC-BD-314
1/2" x 4' x 8' beaded, approx. 3 1/4" OC



MDF 1248-ITC-VG-514
1/2" x 4' x 8' vee grooved, approx. 5 1/4" OC

GISSO PINE CROWNS

Degree shown on crown mouldings = spring angle

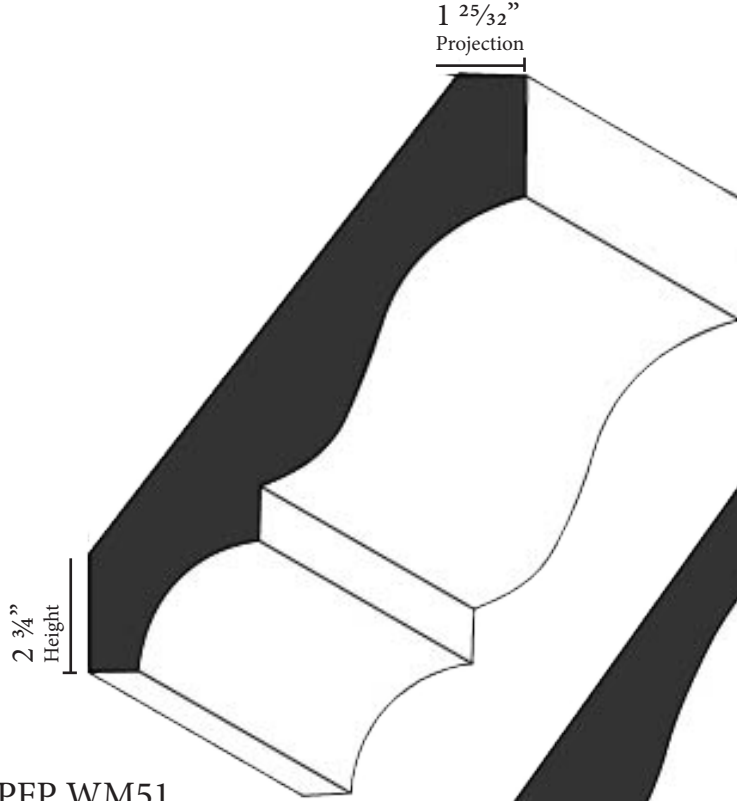

PFP WM51
 $\frac{9}{16}$ " x $3 \frac{1}{4}$ " x 16'
 (34.5)

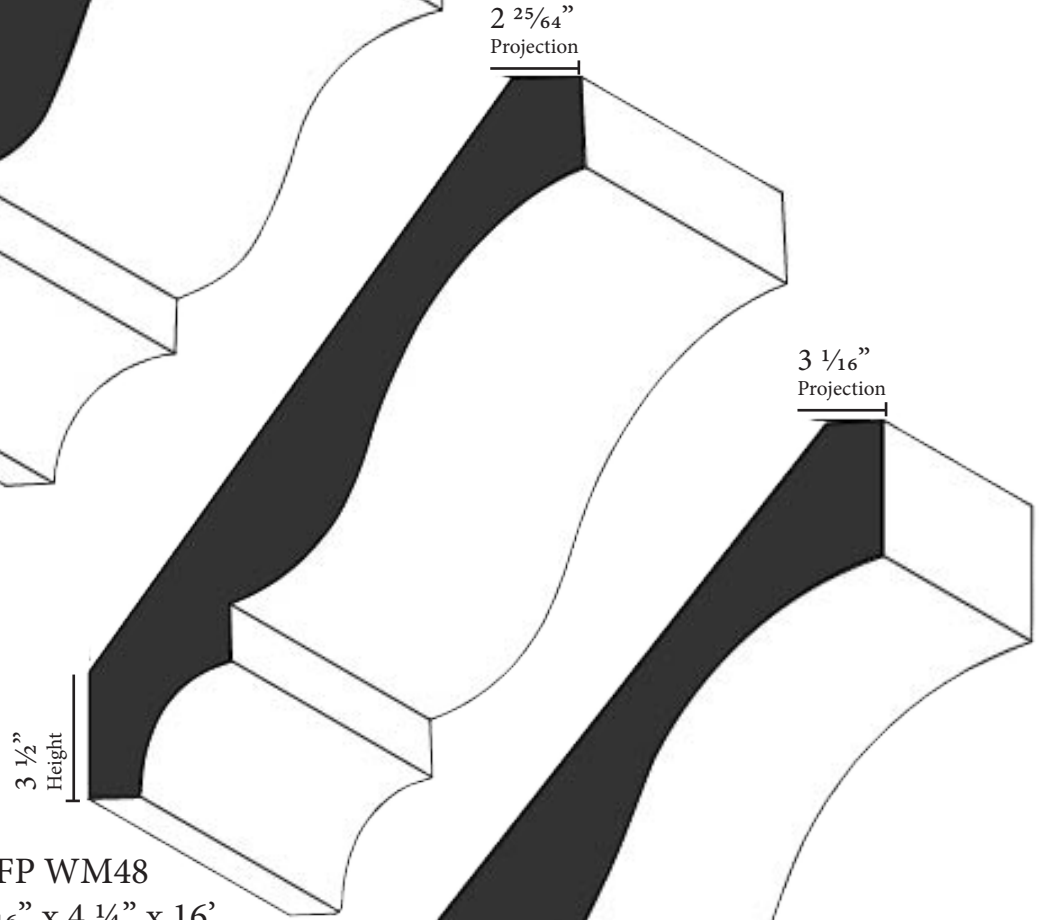

PFP WM48
 $\frac{9}{16}$ " x $4 \frac{1}{4}$ " x 16'
 (35.5)

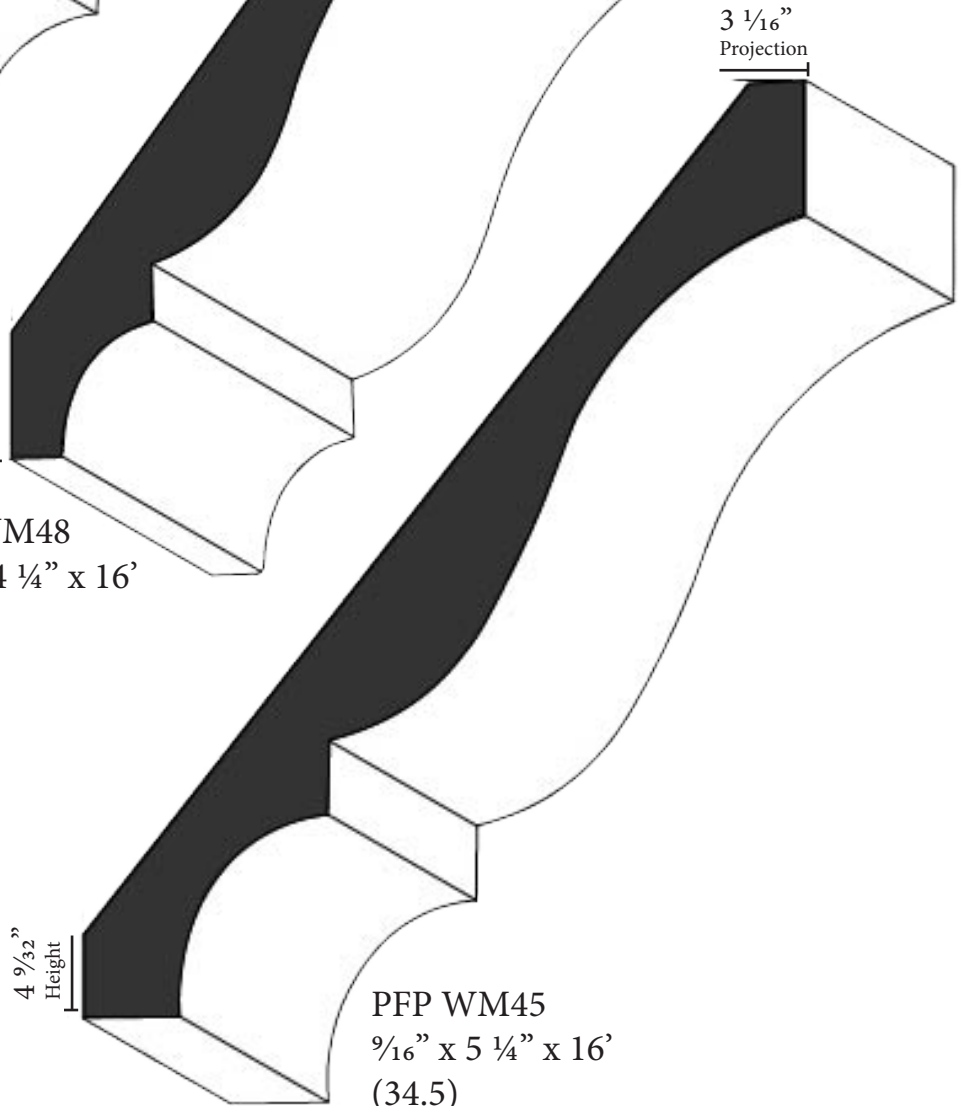

PFP WM45
 $\frac{9}{16}$ " x $5 \frac{1}{4}$ " x 16'
 (34.5)

GEDSO PINE CROWNS & SHIPLAP

Degree shown on crown mouldings = spring angle

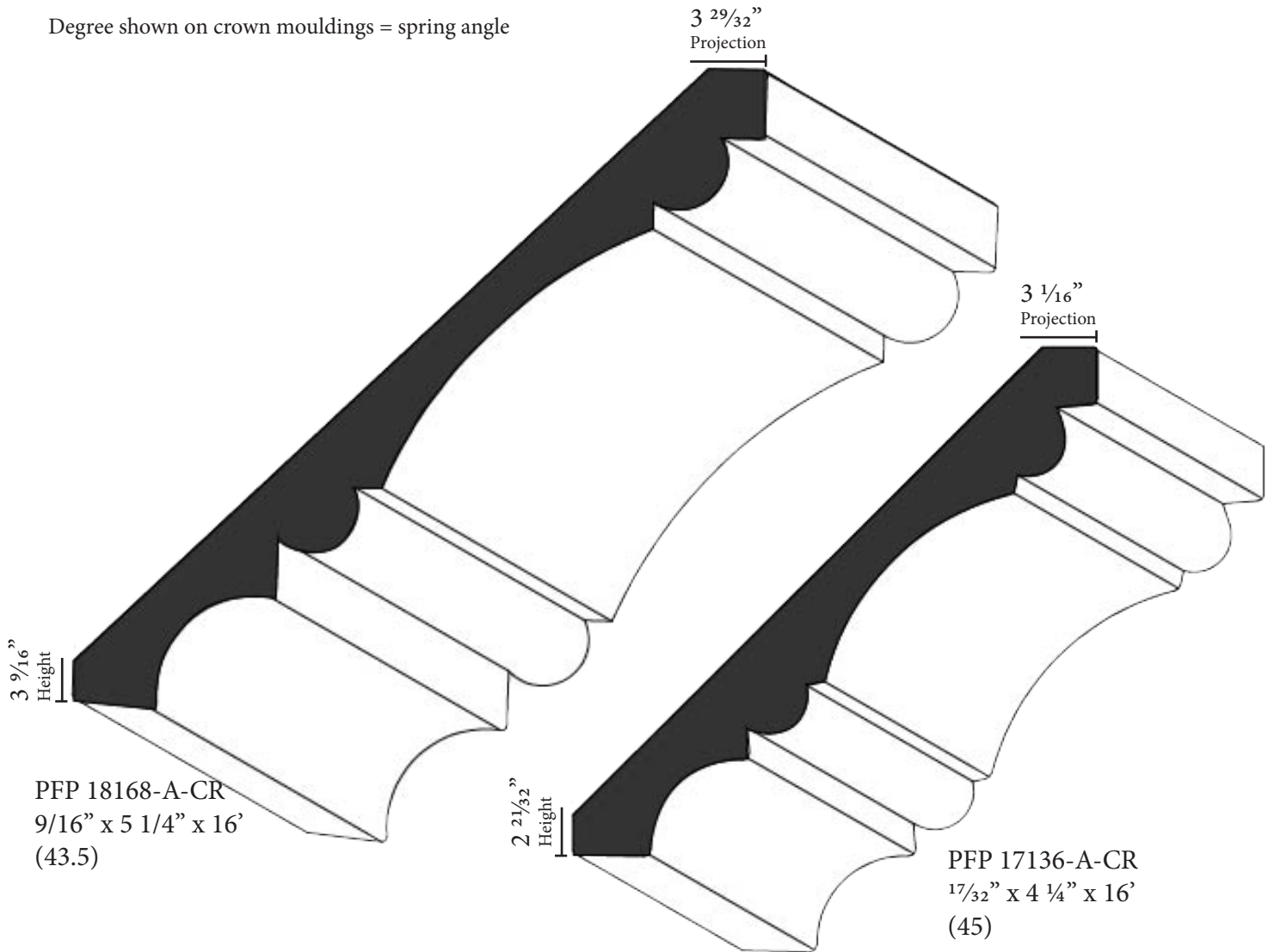

PFP 18168-A-CR
9/16" x 5 1/4" x 16'
(43.5)

PFP 17136-A-CR
17/32" x 4 1/4" x 16'
(45)

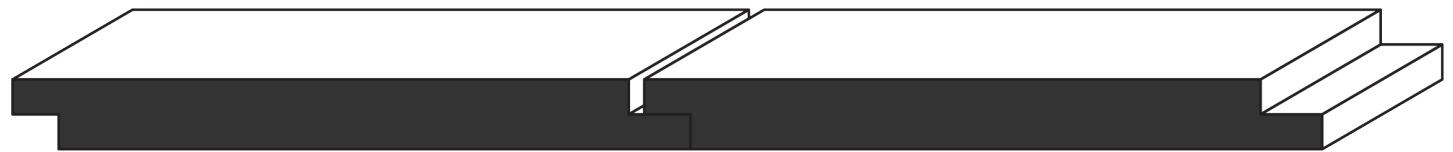

18172-SL
9/16" x 5 3/8" (5" coverage) x 16'

18236-SL
9/16" x 7 3/8" (7" coverage) x 16'

DENTIL CROWNS

Degree shown on crown mouldings = spring angle

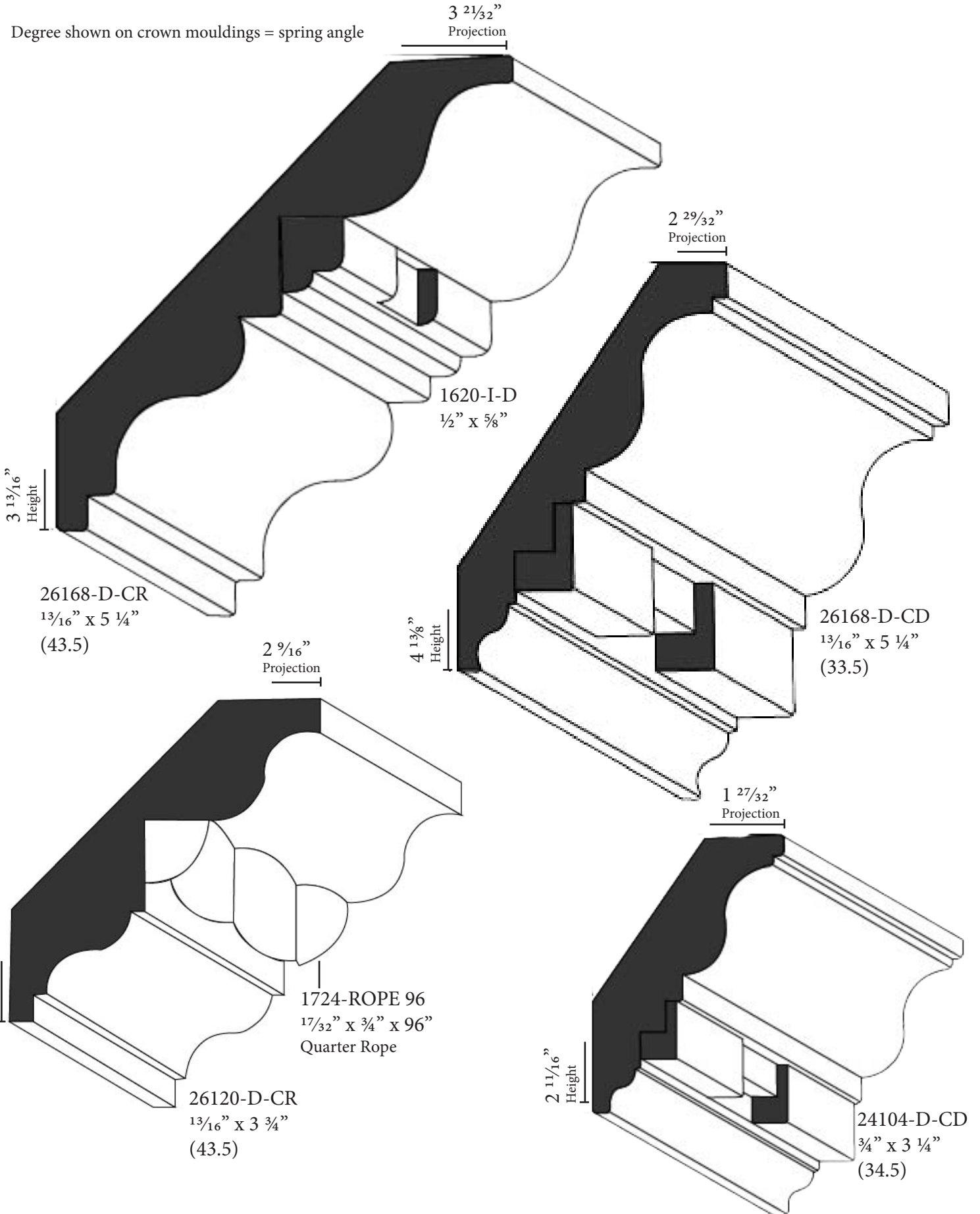

CROWN BACKERS

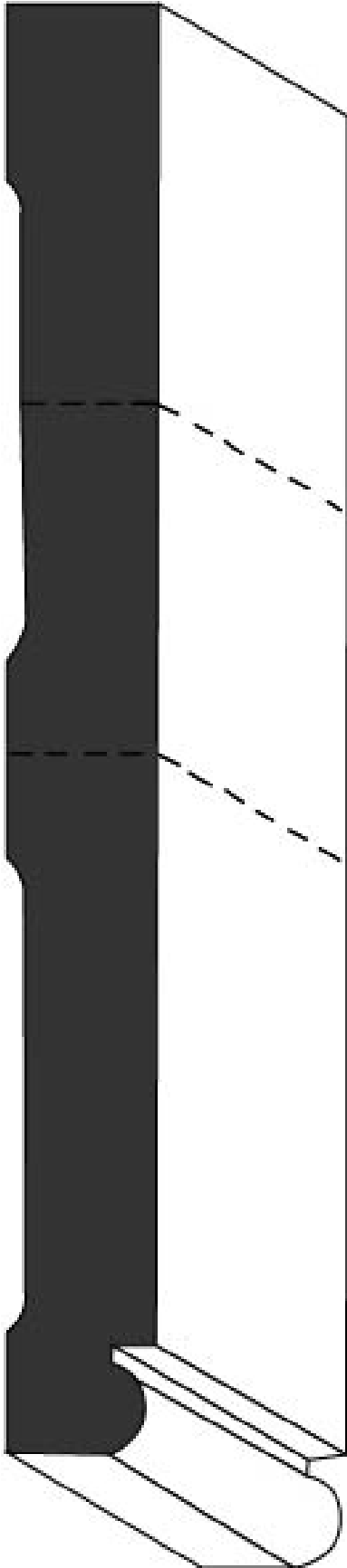

24232-BD-B
 $\frac{3}{4}$ " x $7\frac{1}{4}$ "

24168-BD-B
 $\frac{3}{4}$ " x $5\frac{1}{4}$ "

24112-BD-B
 $\frac{3}{4}$ " x $3\frac{1}{2}$ "



32128-CRB
1" x 4"

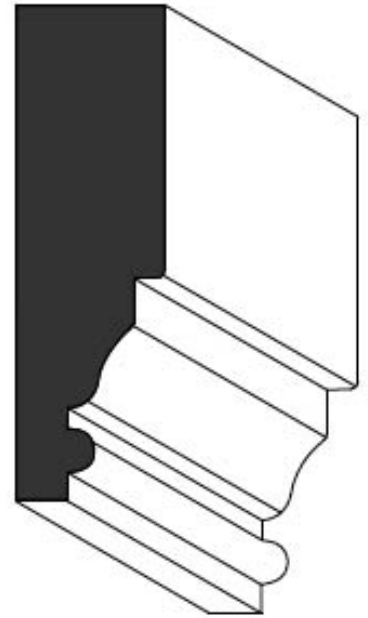

2480-CRB
 $\frac{3}{4}$ " x $2\frac{1}{2}$ "

DENTILS AND MANTEL MOULD

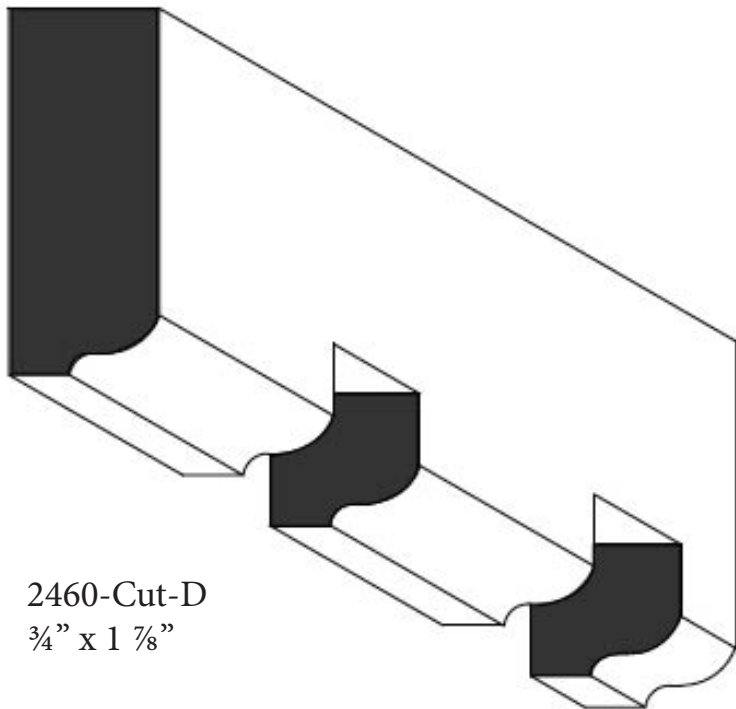

2460-Cut-D
 $\frac{3}{4}$ " x $1 \frac{7}{8}$ "

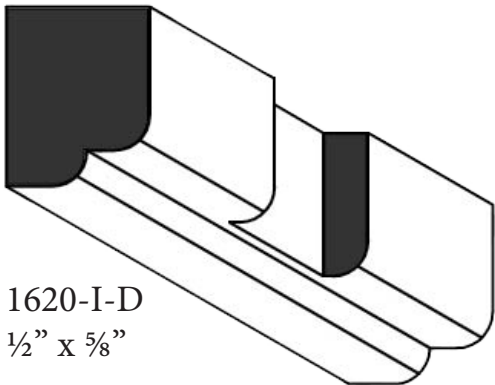

1620-I-D
 $\frac{1}{2}$ " x $\frac{5}{8}$ "

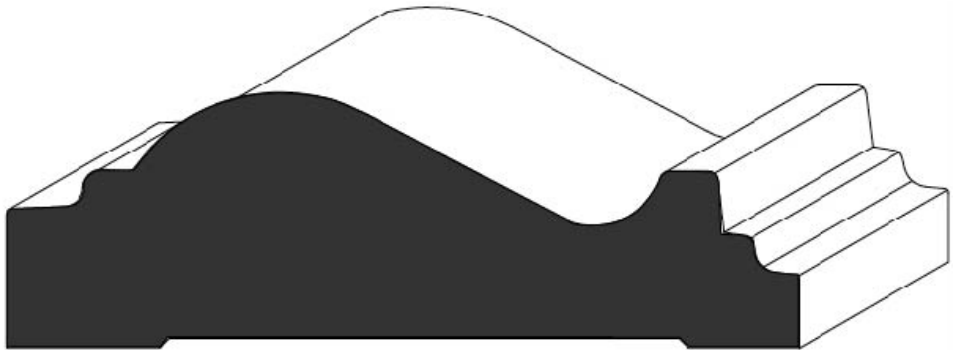

54168-A-MM $1 \frac{11}{16}$ " x $5 \frac{1}{4}$ "

CHAIR RAILS & STOPS

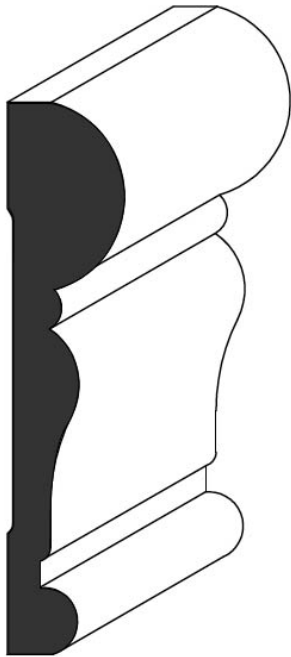

22104-CH $1\frac{1}{16}$ " x $3\frac{1}{4}$ "

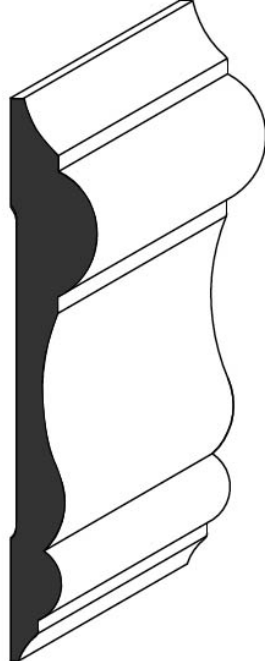

16104-CH $\frac{1}{2}$ " x $3\frac{1}{4}$ "

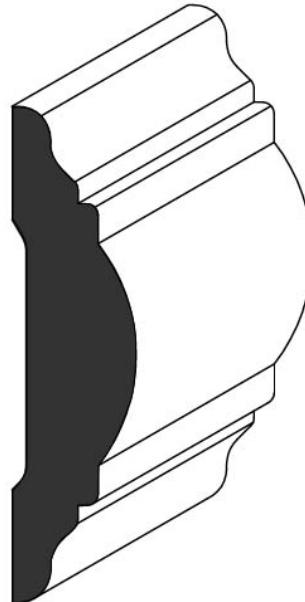

2288-CH $1\frac{1}{16}$ " x $2\frac{3}{4}$ "

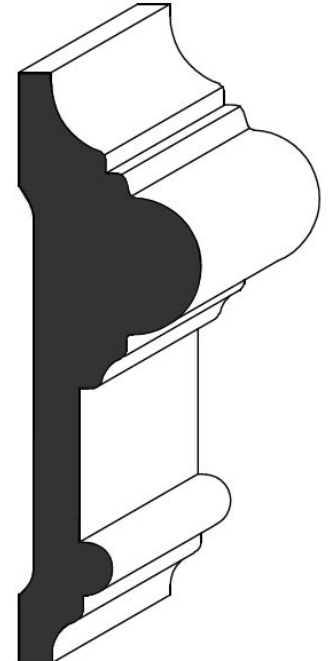

32104-CH 1" x $3\frac{1}{4}$ "

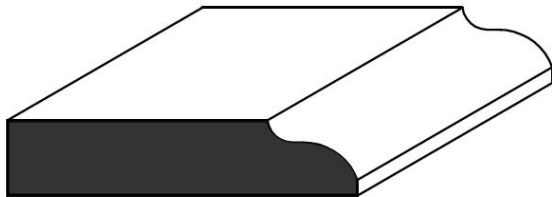

1256-Stop $\frac{3}{8}$ " x $1\frac{3}{4}$ "

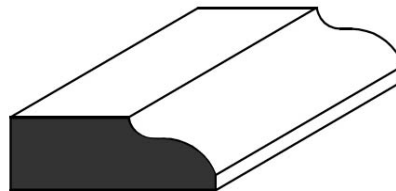

1234-Stop $\frac{3}{8}$ " x $1\frac{1}{16}$ "

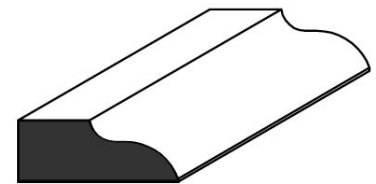

1026-Stop $\frac{5}{16}$ " x $1\frac{3}{16}$ "

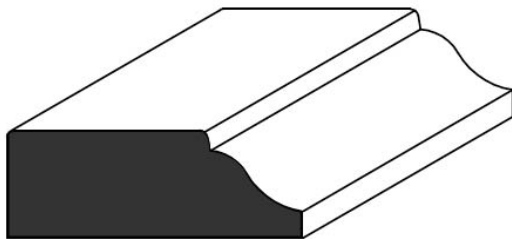

1644-KW-Stop $\frac{1}{2}$ " x $1\frac{3}{8}$ "

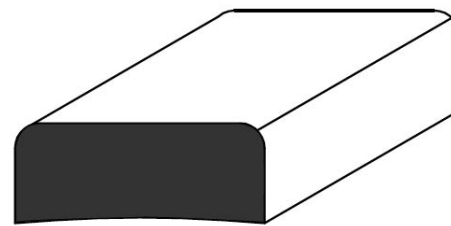

1640-Stop $\frac{1}{2}$ " x $1\frac{3}{8}$ "

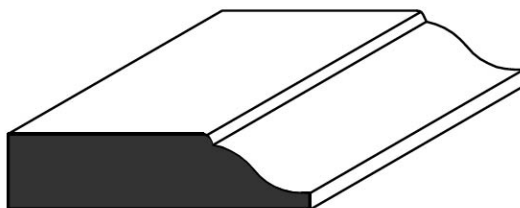

1144-Stop $1\frac{1}{32}$ " x $1\frac{3}{8}$ "



PFP 1344-STOP $1\frac{3}{32}$ " x $1\frac{3}{8}$ " x 81"

TRIM

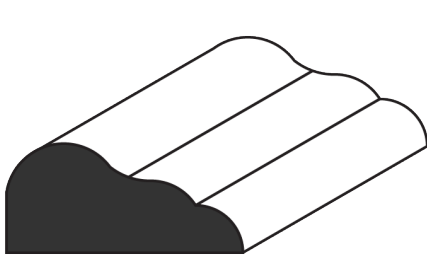

1840 $\frac{9}{16}$ " x $1\frac{1}{4}$ "

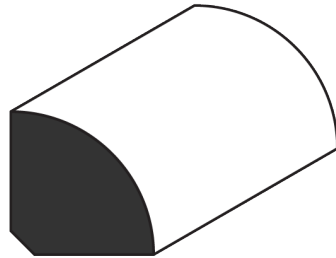

2424-Q $\frac{3}{4}$ " x $\frac{3}{4}$ "

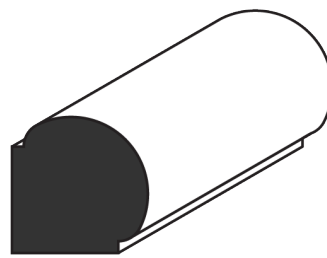

2323-Bead $\frac{23}{32}$ " x $\frac{23}{32}$ "

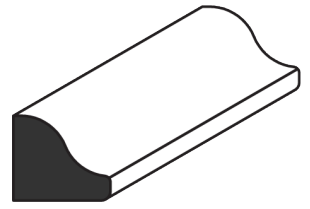

1416-GB $\frac{7}{16}$ " x $\frac{1}{2}$ "

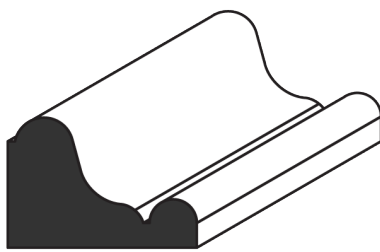

2232-TM $1\frac{1}{16}$ " x 1 "

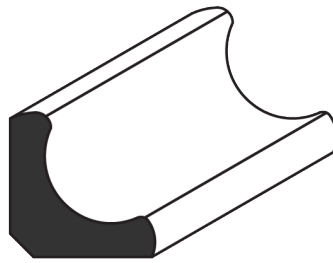

2424-I $\frac{3}{4}$ " x $\frac{3}{4}$ "

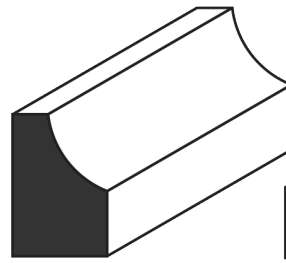

1624-C $\frac{1}{2}$ " x $\frac{3}{4}$ "

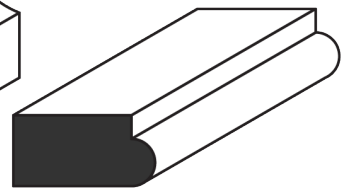

1224-KR $\frac{3}{8}$ " x $\frac{3}{4}$ "

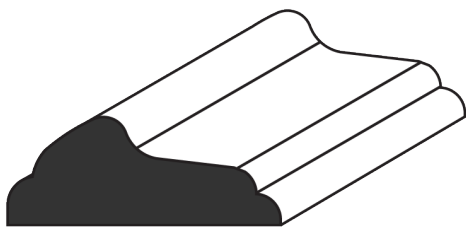

1846 $\frac{9}{16}$ " x $1\frac{7}{16}$ "

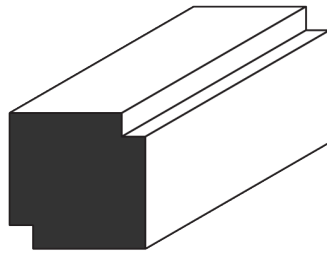

2323-IT-TM $\frac{23}{32}$ " x $\frac{23}{32}$ "

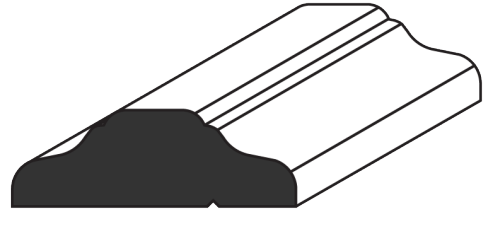

1648 $\frac{1}{2}$ " x $1\frac{1}{2}$ "

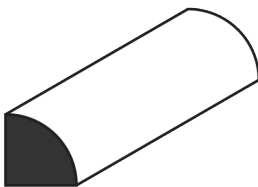

1212-Q $\frac{3}{8}$ " x $\frac{3}{8}$ "

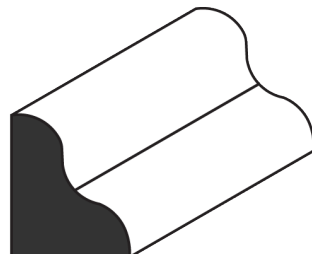

2024 $\frac{5}{8}$ " x $\frac{3}{4}$ "

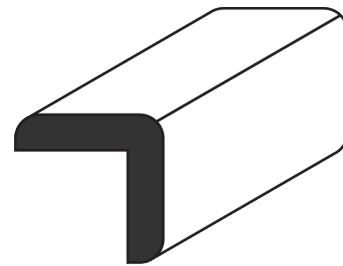

2424-O $\frac{3}{4}$ " x $\frac{3}{4}$ "

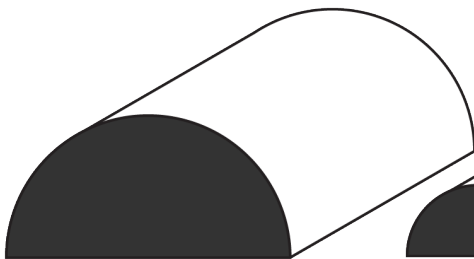

2448-HR $\frac{3}{4}$ " x $1\frac{1}{2}$ "



1224-T $\frac{3}{8}$ " x $\frac{3}{4}$ "

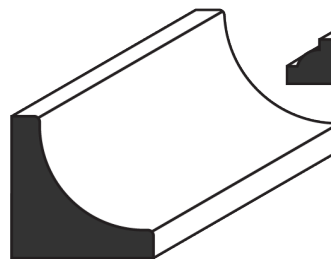

2424-C $\frac{3}{4}$ " x $\frac{3}{4}$ "

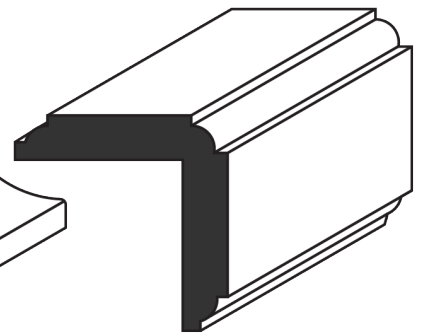

3636-O $1\frac{1}{8}$ " x $1\frac{1}{8}$ "

TRIM AND MULLS

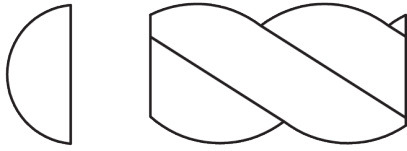

1124-Rope 96 $1\frac{1}{32}$ " x $\frac{3}{4}$ " 96" Half Rope
Sold in pieces

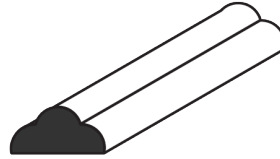

816 $\frac{1}{4}$ " x $\frac{1}{2}$ "

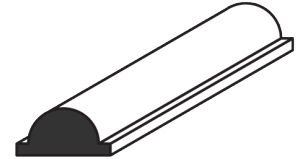

816-A $\frac{1}{4}$ " x $\frac{1}{2}$ "

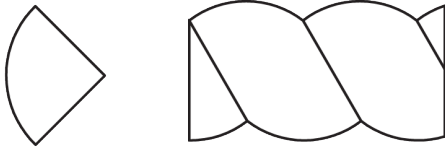

1724-Rope 96 $1\frac{7}{32}$ " x $\frac{3}{4}$ " 96" Quarter Rope
Sold in pieces

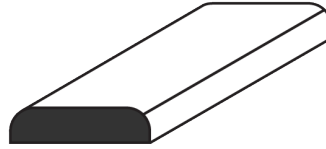

624 $\frac{3}{16}$ " x $\frac{3}{4}$ "

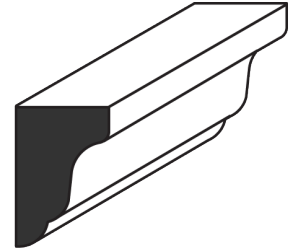

1624 $\frac{1}{2}$ " x $\frac{3}{4}$ "

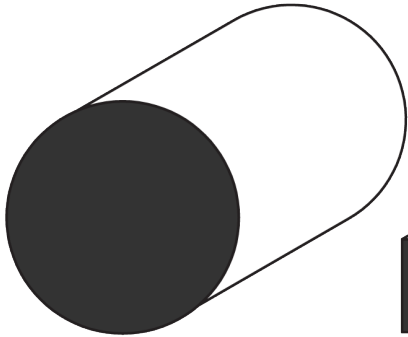

4040-ROD $1\frac{1}{4}$ " x $1\frac{1}{4}$ "

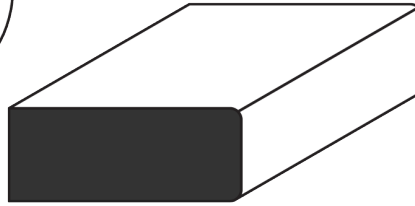

1640-2RE116 $\frac{1}{2}$ " x $1\frac{1}{4}$ "

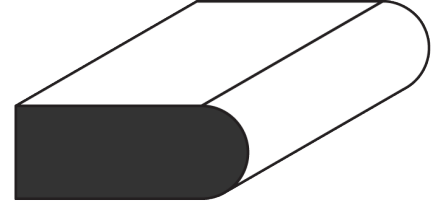

1640-BN $\frac{1}{2}$ " x $1\frac{1}{4}$ "

2323-IT-TM $2\frac{3}{32}$ " x $2\frac{3}{32}$ "



864-M $\frac{1}{4}$ " x 2"

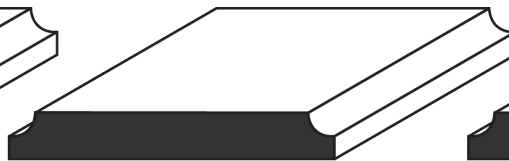

856-M $\frac{1}{4}$ " x $1\frac{3}{4}$ "

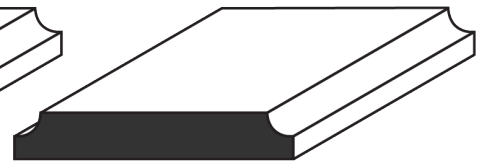

848-M $\frac{1}{4}$ " x $1\frac{1}{2}$ "

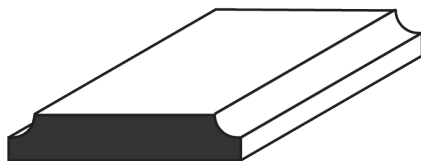

840-M $\frac{1}{4}$ " x $1\frac{1}{4}$ "

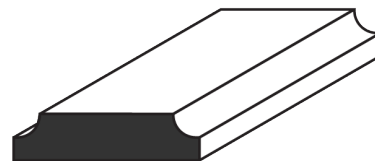

832-M $\frac{1}{4}$ " x 1"

PANEL MOULDS

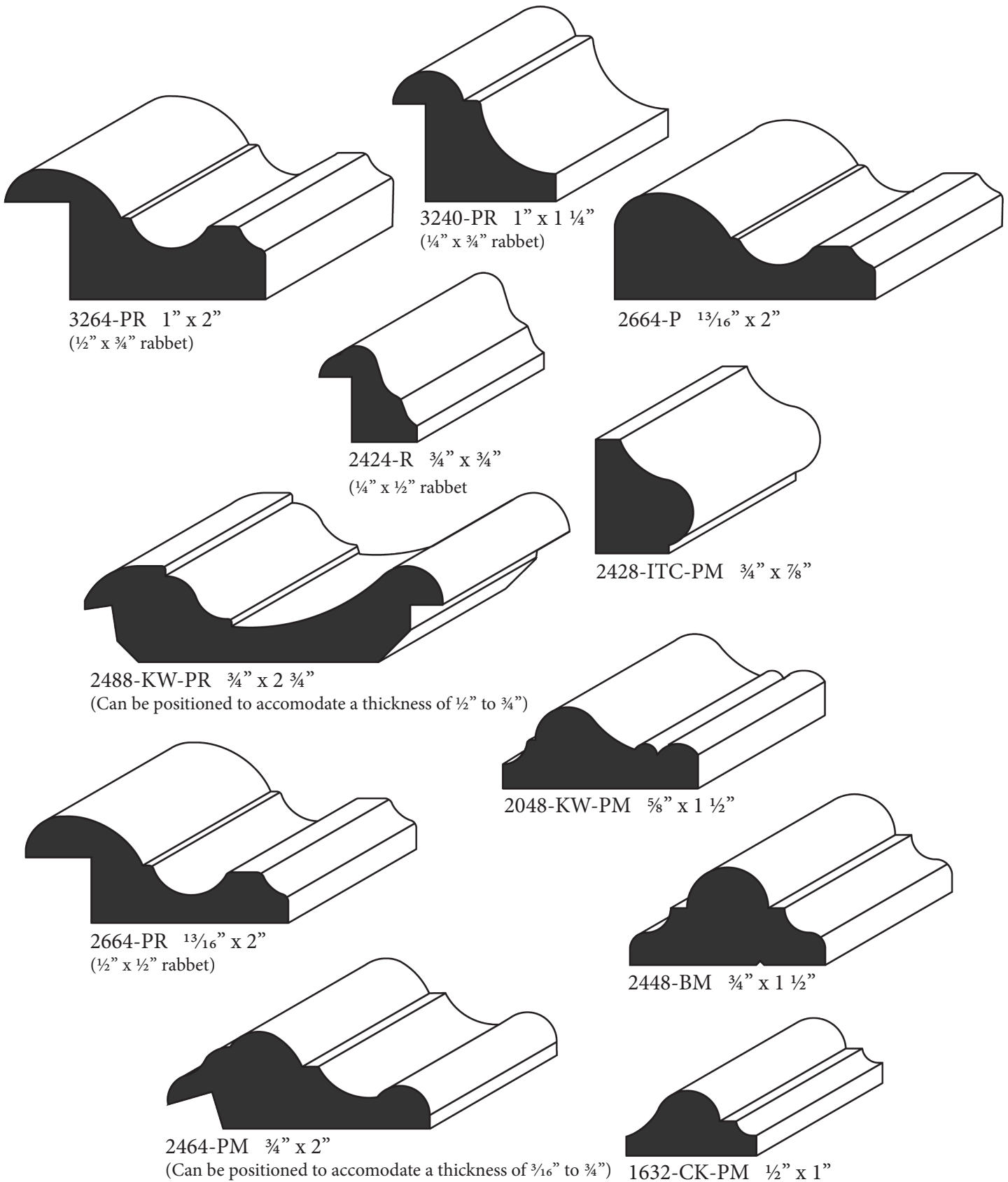

STOOLS



24136-STOOL $\frac{3}{4}$ " x $4\frac{1}{4}$ "



2472-A-STOOL $\frac{3}{4}$ " x $2\frac{1}{4}$ "



40104-STOOL $1\frac{1}{4}$ " x $3\frac{1}{4}$ "



2472-STOOL $\frac{3}{4}$ " x $2\frac{1}{4}$ "

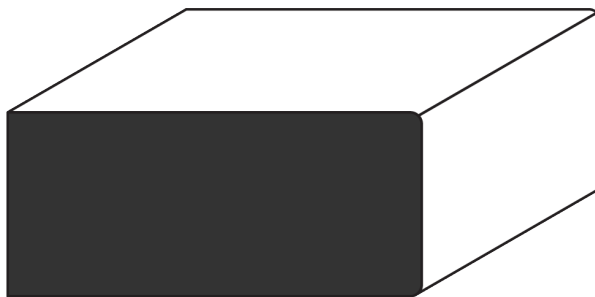

3273-2RE116 1" x $2\frac{1}{4}$ "

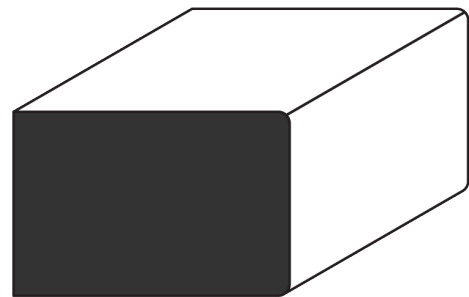

3248-2RE116 1" x $1\frac{1}{2}$ "

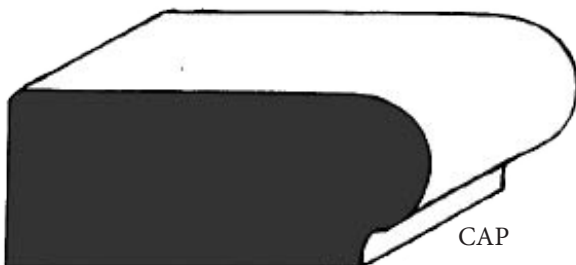

2472-MC-STOOL 1" x $2\frac{1}{4}$ "
*Available in Oak and Poplar

BAR RAILS

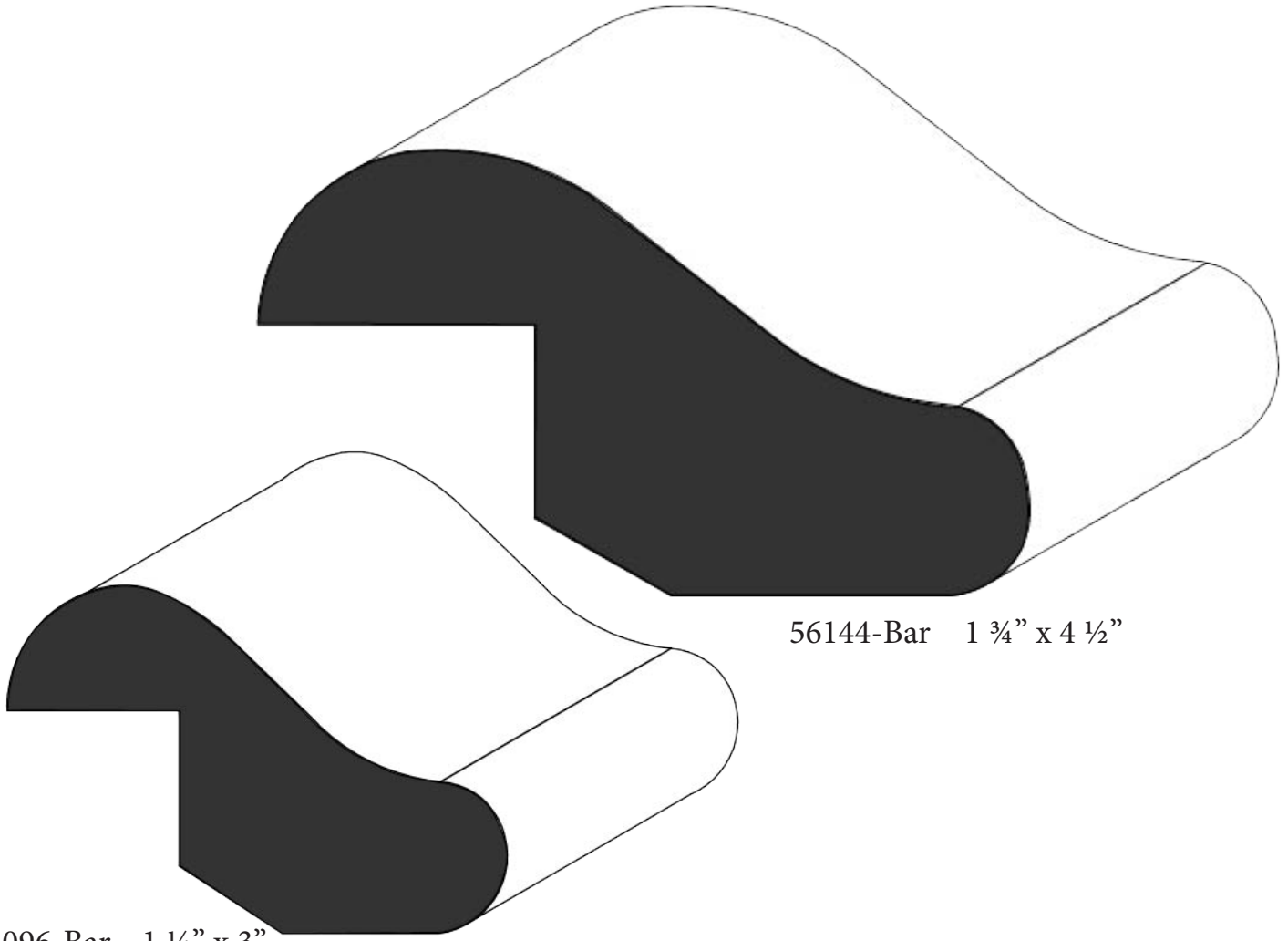

56144-Bar 1 3/4" x 4 1/2"

4096-Bar 1 1/4" x 3"

PRIMED MDF TONGUE & GROOVE

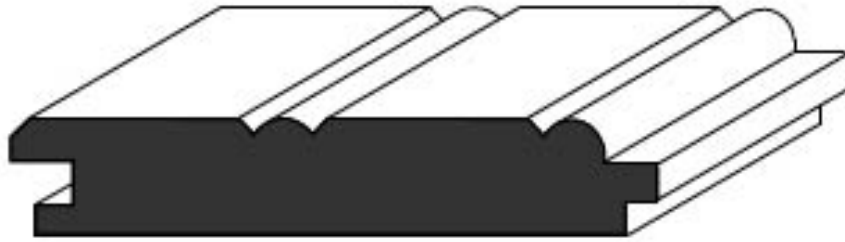

15M96-TVG-BD 15mm x 3"

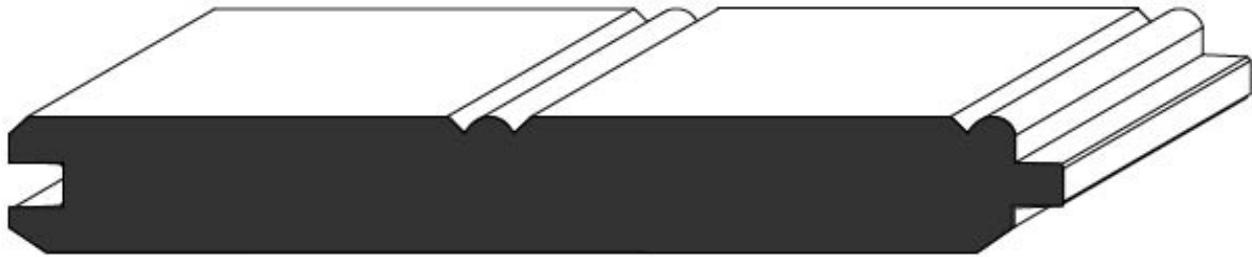

18M168-TVG-BD 18mm x 5 1/4"



18M160-TVG 18mm x 5 1/4"



24224-QRK-TAG 3/4" x 7"



24160-QRK-TAG 3/4" x 5"

TONGUE & GROOVE



24160-TVG 3/4" x 5" (face)



24128-TVG 3/4" x 4" (face)



2496-TVG 3/4" x 3" (face)

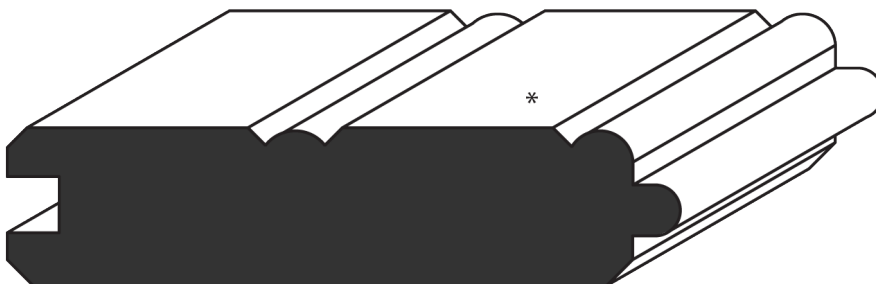

2496-TVG-BD 3/4" x 3" (face)



1296-TVG-BD 3/8" x 3" (face)

* Face Side

TONGUE & GROOVE



24160-QRK-TAG $\frac{3}{4}$ " x 5" (face)



24224-QRK-TAG $\frac{3}{4}$ " x 7" (face)

* Face Side

S4S

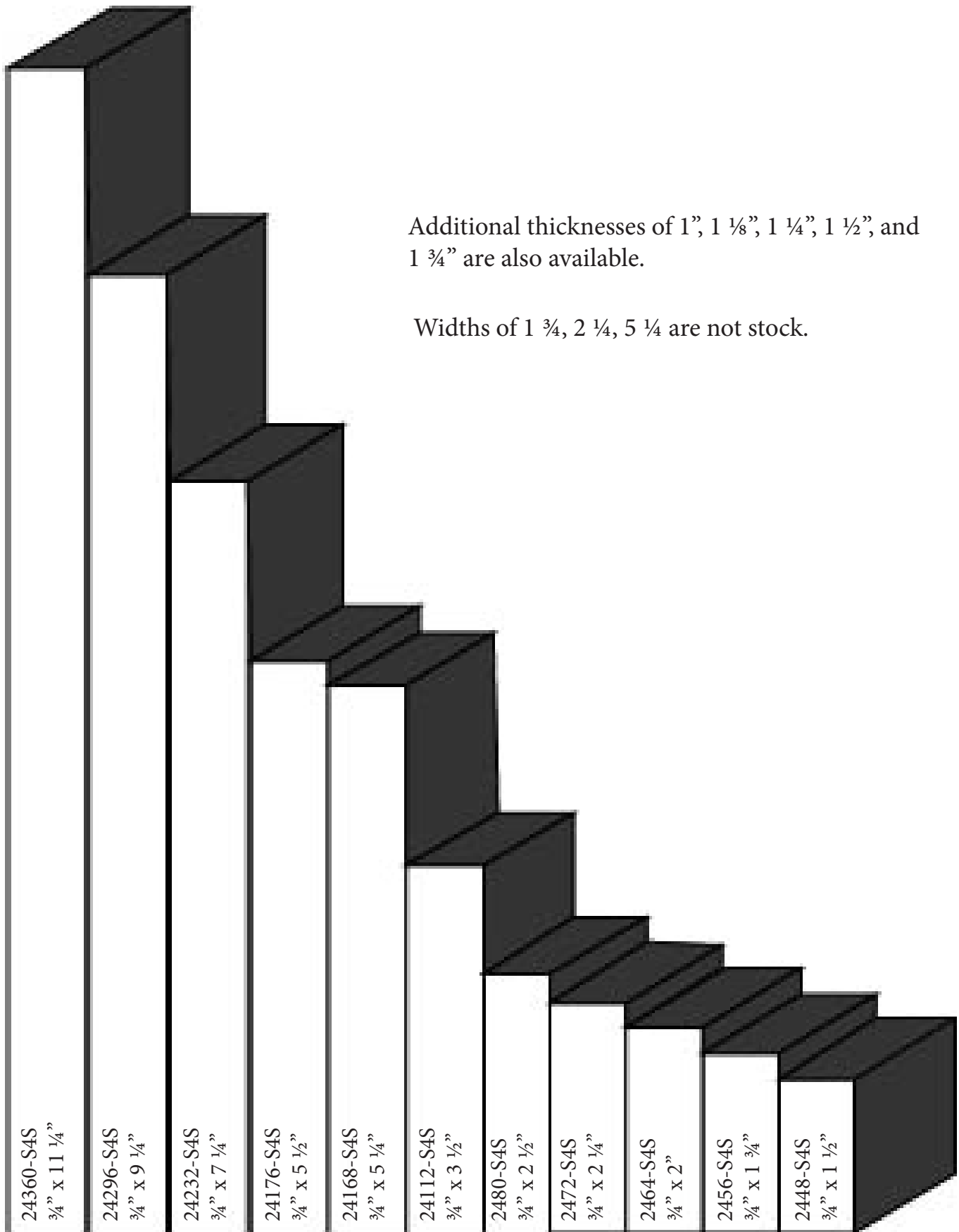

PRIMED PINE S4S

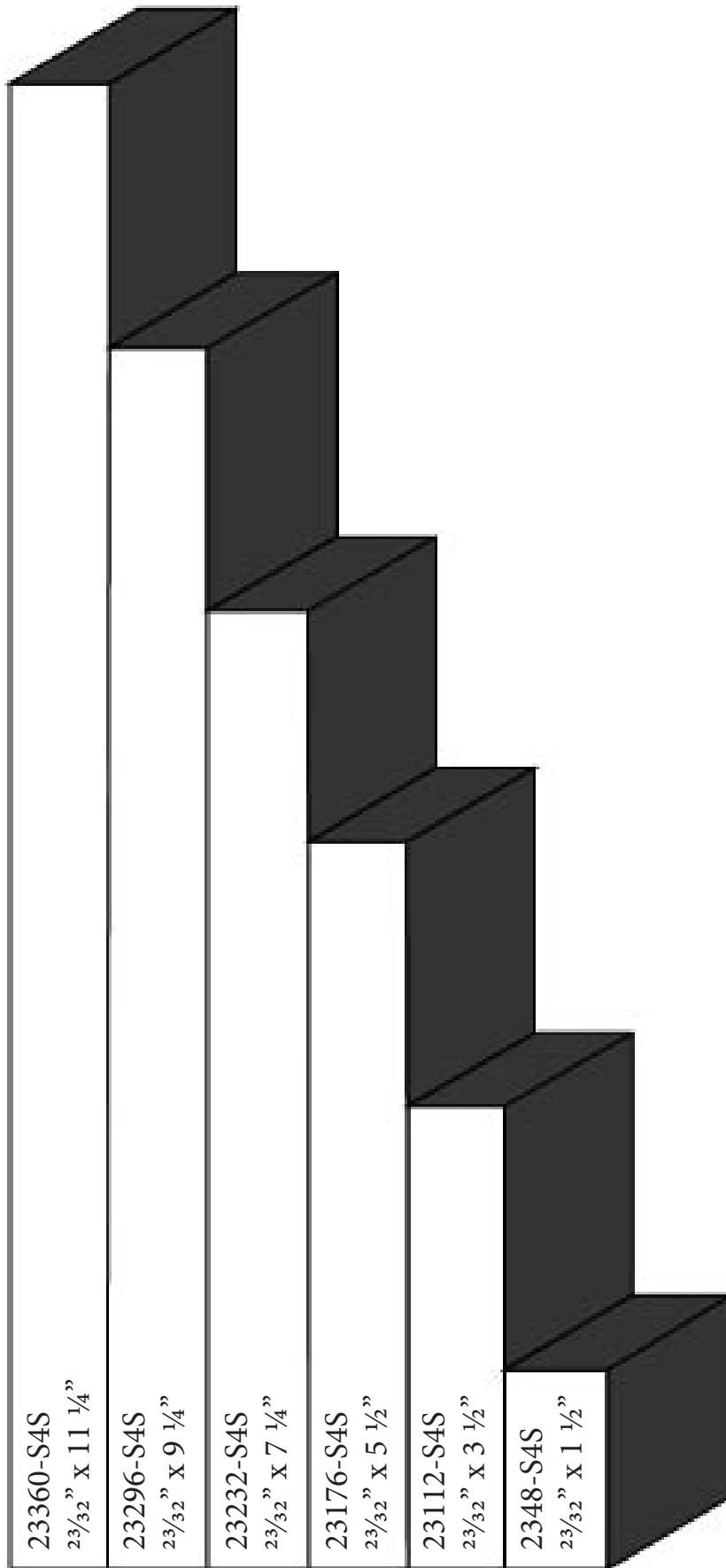

Additional Products and Services

Interior Wood Products is committed to being the industry leader in service, product offering, and value. See below for our specialty items and services.

Mill Services

Custom Knife Grinding	Ripping
CNC Machining	Planing
Interior Door Pre-Hanging	Sanding
Exterior Door Pre-Hanging	Glue Up
Finishing	Fluting



Custom Wood Products

Treads	Wine Cellar Components
Starting Steps	Veneers
Wood Transitions	Plywoods
Cabinet Doors	Wood Columns
Corbels	Wood Components
Table Tops	Decorative Panels
Mantels	Library Paneling
Drawer Boxes	Closet Shelving
Wood Shutters	Rough Lumber
Wood Flooring	



Specialty Hardware and Accessories

Decorative Hardware	Cabinet Hardware
Screws and Fasteners	Hinges
Opening Systems	Drawer Slides
Closet Solutions	Adhesives and Fillers
Sliding Doors and Lateral Opening Systems	Builders Hardware
Bath Hardware	Commercial Hardware
Metal Door Frames	

Logistics

Same-Day / Next-Day Job Site Delivery	Extra Material Pick Up / Return
Local Delivery	Regional / National Shipping
Import / Export of Commodity Products	



Accounting

Individualized Account Managers	Same-Day Invoicing
Account Pricing	Payment Terms
Streamlined Billing	Monthly Account Statements
Volume Discounts and Rebates	Early Pay Discounts
Referral Bonuses	

7795 A Corporate Blvd., Plain City, OH 43064